



GENERAL CATALOGUE

Office Line



Four generations,
a solid background and plenty of experience.

Here we are, planning for the future with
the same dedication as ever.

Elio and Eliana Maestri

Office Line



STAPLING PLIERS

PRIMULA 6	4
PRIMULA 6/2	5
PRIMULA 8	6
PRIMULA 10	7
PRIMULA 12	8
PRIMULA 700	9
EUROPLIER 6	10
EUROPLIER 8	11
EUROPLIER 10	12
EUROPLIER 12	13
EUROSUPER 6	14
EUROSUPER 8-10	15
PARVA 1	16
PARVA 2	17
PARVETTA 6	18
PARVETTA 8	19
PUNCAR SUPER	20
MINI	22
MINI CANDY COLOR	24
MINI JEWEL TONES	26

DESK STAPLERS

EURODESK 50	28
EURODESK 100	29
EURODESK 200	30
EURODESK 250	31
ELY 50	32
ELY 100	33

HEAVY DUTY STAPLERS

ROMALANG 17	34
ROMABLOK 17	36
ROMABLOK 24	38
EUROBLOK 13	40
EUROBLOK 24	41

STAPLE REMOVERS

TOP - EUROREMOVER	42
-------------------	----

SPECIAL EQUIPMENTS

ROMA FUR	43
----------	----



PUNCHERS

EUROPUNCH 21	46
EUROPUNCH 22	47
EUROPUNCH 23	48
EUROPUNCH 24	49
EUROPUNCH 25 2F	50
EUROPUNCH 25 4F	51
EUROPUNCH 4F	52
RO-MA JUMBO	53

PAPER CLIPS

ROMA CLIP	54
-----------	----

SELF-ADHESIVE LABELS

FOR PRINTERS

LABELS	56
--------	----



PRICE LABELLERS

SWING M	60
OPEN	62
LABEL-ROLL	64
INK-ROLL	65



BANKNOTE VERIFIERS

LD1	68
SECUR VVB	69
EURO BJ212	70
EURO 701B	71
AL130	72
DORS230	73

BANKNOTE COUNTING MACHINES

BJ05	74
EUROBANK LD60	75
EURO BJ20	76
DP-7011-SE/3D	77

VALUE COUNTING MACHINES

AL5000A	78
BJ6230	79
DP7100 E/3D	80

COIN SORTING MACHINES

EURO 270	81
EURO 500	82
EURO 650 8/C	83
CS900S	84

Consumables

OFFICE	85
--------	----

PRIMULA 6	4
PRIMULA 6/2	5
PRIMULA 8	6
PRIMULA 10	7
PRIMULA 12	8
PRIMULA 700	9
EUROPLIER 6	10
EUROPLIER 8	11
EUROPLIER 10	12
EUROPLIER 12	13
EUROSUPER 6	14
EUROSUPER 8-10	15
PARVA 1	16
PARVA 2	17
PARVETTA 6	18
PARVETTA 8	19
PUNCAR SUPER	20
MINI	22
MINI CANDY COLOR	24
MINI JEWEL TONES	26
EURODESK 50	28
EURODESK 100	29
EURODESK 200	30
EURODESK 250	31
ELY 50	32
ELY 100	33
ROMALANG 17	34
ROMABLOK 17	36
ROMABLOK 24	38
EUROBLOK 13	40
EUROBLOK 24	41
TOP-EUROREMOVER	42
ROMA FUR	43





PRIMULA 6

STAPLING PLIERS

Modern and ergonomic.
Soft and silent stapling.
Customisable front cover.

Staple load marker.
Rear loading. Ideal for the
office, school, home, DIY.

Available colours:



Customisable plastic cover.



Available in:



CODE	ARTICLE	PACK
0000107	PRIMULA 6 PENTACOLOR	25
> 0000217	PRIMULA 6 PENTACOLOR	10
> blister		

ANTIBLOCK system

Automatic unjamming mechanism



1.000 staples ► INCLUDED

64 (6/4)

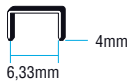

Page 85

jolly | **puntooro 64** | **64 GLOBAL** | **64**

Original Maestri staple use recommended



80 mm

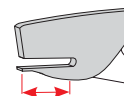

46 mm



10/12



0,23

PRIMULA 6/2

CODE	ARTICLE	PACK
0000412	PRIMULA 6/2 PENTACOLOR	25

ANTIBLOCK
system
Automatic unjamming
mechanism

Available colours:



Customisable plastic cover.



Rotating anvil permits
closed stapling **A**
open stapling **B**

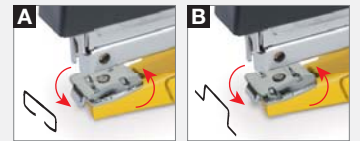

In the open staple position, **B** if needed, it allows staples to be manually removed, thus avoiding permanent sheet stapling (max 3).



Available in:



64 (6/4)

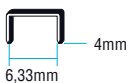

Page 85

jolly® punto oro 64 | 64 GLOBAL | 64

Original Maestri staple use recommended



80 mm

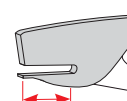

46 mm



2/3



0,21



PRIMULA 8

STAPLING PLIERS

Modern and ergonomic.
Soft and silent stapling.
Customisable front cover.

Staple load marker.
Rear loading. Ideal for the
office, school, home, DIY.

Available colours:



Customisable plastic cover.



Available in:



CODE	ARTICLE	PACK
0011002	PRIMULA 8 PENTACOLOR	25

ANTIBLOCK system

Automatic unjamming mechanism



8/4

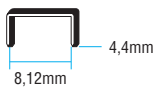

8/4

Page 85

Original Maestri staple use recommended



80 mm

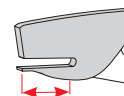

46 mm



10/12



0,21

PRIMULA 10

CODE	ARTICLE	PACK
0014002	PRIMULA 10 PENTACOLOR	25

ANTIBLOCK
system
Automatic unjamming
mechanism

Available colours:



Customisable plastic cover.



Available in:



N10

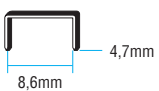

N10

Original Maestri staple use recommended



80 mm

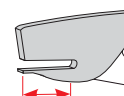

46 mm



10/12



0,21



PRIMULA 12

STAPLING PLIERS

Solid, manageable, professional with customisable front cover.

Metal body. Rear loading. Ideal to staple slightly thicker items,

highly used in stores, supermarkets, warehouses, laboratories, florists.

Staple load marker.



Customisable plastic cover.



Available in:



CODE	ARTICLE	PACK
0022003	PRIMULA 12	10
> 0022057	PRIMULA 12	8
> blister		



400 staples ► INCLUDED

24/

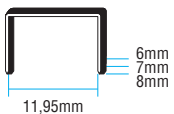

Page 85

puntofino 126-128 | 126 GLOBAL

Original Maestri staple use recommended



105 mm

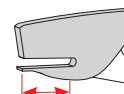

56 mm



20/23 (126)
30 (128)



0,39

PRIMULA 700

Designed for special applications with crimped staples, ideal for dry cleaners and laundromats.

CODE	ARTICLE	PACK
0022501	PRIMULA 700	10



Staple load marker.



Customisable plastic cover.



Available in:



For undulated staples ▶



CP700

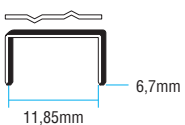

CP700

Original Maestri staple use recommended

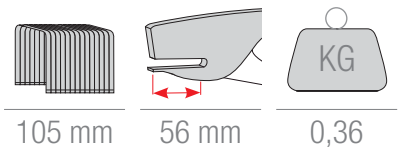



EUROPLIER 6

STAPLING PLIERS

Elegant, with ergonomic design and rounded handles designed to provide the greatest ease

of use and obtain soft and precise stapling with minimum effort. Full metal construction with duo finish

impact: painted top part and polished bottom part.

Available in:



CODE	ARTICLE	PACK
0001401	EUROPLIER 6	25

ANTIBLOCK system

Automatic unjamming mechanism



1.000 staples INCLUDED

64 (6/4)

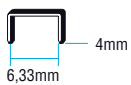

Page 85



Original Maestri staple use recommended



80 mm

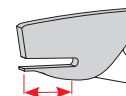

45 mm



10/12



0,26

EUROPLIER 8

CODE	ARTICLE	PACK
0011201	EUROPLIER 8	25

Available in:



ANTIBLOCK
system
Automatic unjamming
mechanism

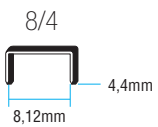

8/4

Original Maestri staple use recommended

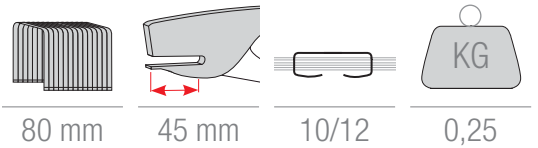



STAPLING PLIERS

EUROPLIER 10

Elegant, with ergonomic design and rounded handles designed to provide the greatest ease

of use and obtain soft and precise stapling with minimum effort. Full metal construction with duo finish

impact: painted top part and polished bottom part.

Available in:



CODE	ARTICLE	PACK
0014220	EUROPLIER 10	25

ANTIBLOCK system

Automatic unjamming mechanism



N10

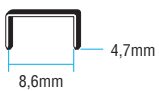

N10

Original Maestri staple use recommended



80 mm

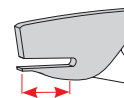

45 mm



10/12



0,25

Ideal for heavy duty stapling.

EUROPLIER 12

CODE	ARTICLE	PACK
0022401	EUROPLIER 12	10

Rotating anvil permits closed stapling **A**
open stapling **B**

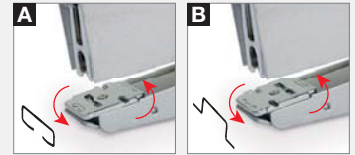

In the open staple position, **B** if needed, it allows staples to be manually removed, thus avoiding permanent sheet stapling (max 5).

Available in:

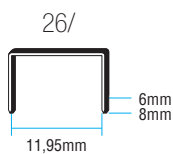
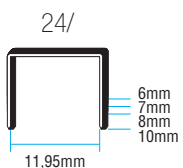

puntoPro 126-128 | 126-1210 GLOBAL



90 mm

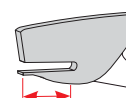

55 mm

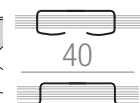

5



0,38



EUROSUPER 6

STAPLING PLIERS

The ample grip, rounded forms, shape of the two handles and softness of clinching

make the Eurosuper series appreciated for its ergonomics and easy use.

Available colours:



Front loading with pushbutton opening.



Available in:



CODE	ARTICLE	PACK
0006055	EUROSUPER 6	20



64 (6/4)

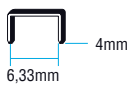

Page 85

jolly | **puntoffice 64** | **64 GLOBAL** | **64**

Original Maestri staple use recommended



57 mm

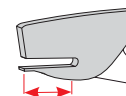

41 mm



10/12



0,28

EUROSUPER 8-10

CODE	ARTICLE	PACK
0011235	EUROSUPER 8-10	20



Available colours:



Front loading with pushbutton opening.



Available in:

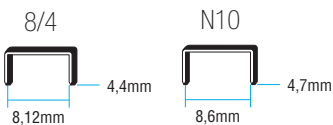

8/4 | N10

Original Maestri staple use recommended



57 mm

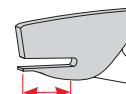

41 mm



10/12



0,29 KG

PARVA 1

STAPLING PLIERS

The most traditional and well-known stapling pliers. Robust and elegant. Maximum stapling depth.

Full metal construction, rear loading. Essential for the office, home, store, school.

Available colours:



Available in:



CODE	ARTICLE	PACK
0002170	PARVA 1	25



64 (6/4)

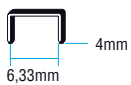

Page 85

jolly | **puntooro 64** | **64 GLOBAL** | **64**

Original Maestri staple use recommended



72 mm

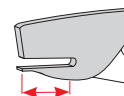

56 mm



10/12



0,24

PARVA 2

CODE	ARTICLE	PACK
0002220	PARVA 2	25

Available colours:



Rotating anvil permits closed stapling **A**
open stapling **B**

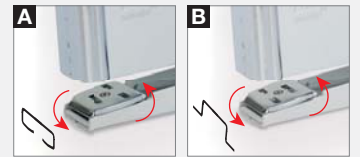

In the open staple position, **B** if needed, it allows staples to be manually removed, thus avoiding permanent sheet stapling (max 3).

Available in:



64 (6/4)

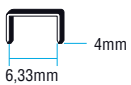

Page 85

jolly | **puntofiro 64** | **64 GLOBAL** | **64**

Original Maestri staple use recommended



72 mm

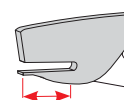

56 mm

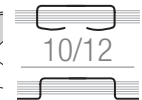

2/3



0,24



PARVETTA 6

STAPLING PLIERS

High quality full metal construction office stapling pliers.

Modern and attractive design with painted top and polished bottom.

Rear loading.

Available colours:



Customisable label.



Available in:



CODE	ARTICLE	PACK
0000050	PARVETTA 6	20



1.000 staples INCLUDED

64 (6/4)

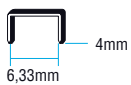

Page 85

jolly | **puntoafiro 64** | **64 GLOBAL** | **64**

Original Maestri staple use recommended



85 mm

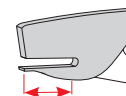

42 mm



10/12



0,24

PARVETTA 8

CODE	ARTICLE	PACK
0011045	PARVETTA 8	20

Available colours:



Customisable label.



Available in:



8/4

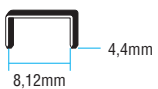

8/4

Original Maestri staple use recommended



85 mm

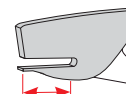

42 mm



10/12



0,24



STAPLING PLIERS

PUNCAR SUPER

Extremely elegant stapler. Robust, ergonomic, lightweight with aluminium alloy top handle. For the office, home, school.

Available colours:



Front loading with pushbutton opening.



Anvil permits closed stapling **A** open stapling **B**

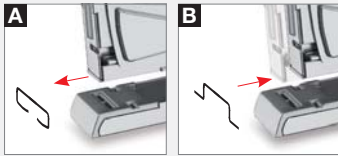

The **Sliding System** solution in the open staple position, **B** if necessary, allows staples to be manually removed, thus avoiding permanent sheet stapling (max 3).



CODE	ARTICLE	PACK
0099260	PUNCAR SUPER	1



Available in:



1.000 staples ► INCLUDED





▲ 10-STAPLER COUNTERTOP DISPLAY

64 (6/4)

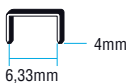

Page 85

jolly | **puntofiro 64** | **64 GLOBAL** | **64**

Original Maestri staple use recommended



55 mm

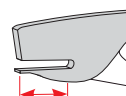

52 mm



2/3



0,31

STAPLING PLIERS

High quality full metal construction mini office stapling pliers. Modern and ergonomic design thanks

to the two rounded handles designed to provide the greatest ease of use to obtain soft and precise

stapling with minimum effort.

Available colours:



Available in:



CODE	ARTICLE	PACK
0014176	MINI	1



1.000 staples ► INCLUDED



▲ 20-MINI STAPLER COUNTERTOP DISPLAY

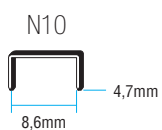

Page 85

N10

Original Maestri staple use recommended



39 mm

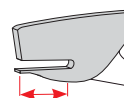

27 mm



12/15



0,13



MINI CANDY COLOR

Available colours:



Available in:



A DIFFERENT
maestri[®]
TOUCH

MADE in ITALY

STAPLING PLIERS

Office mini stapling plier with double effect glittered painting. Precious satin chromed finishing for the

lower handle. Modern and ergonomic design thanks to the two rounded handles designed to provide the

greatest ease of use to obtain soft and precise stapling with minimum effort.

CODE	ARTICLE	PACK
0014190	MINI CANDY COLOR PINK	4
0014191	MINI CANDY COLOR YELLOW	4
0014192	MINI CANDY COLOR BLUE	4
0014193	MINI CANDY COLOR LIGHT BLUE	4
0014194	MINI CANDY COLOR GREEN	4
0099932	DISPLAY PLEXIGLASS MINI CANDY COLOR (15pcs)	1





◀ 15-MINI STAPLER
COUNTERTOP DISPLAY

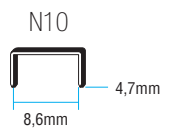

N10

Original Maestri staple use recommended

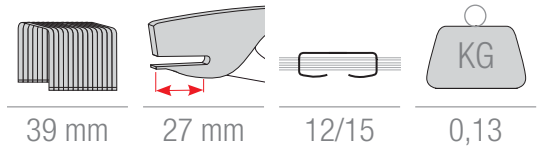



MINI JEWEL TONES

Available colours:



Available in:



A DIFFERENT
maestri[®]
TOUCH

MADE in ITALY

STAPLING PLIERS

*Office mini stapling plier
finished with elegant and
refined colored velvet.
Precious satin chromed*

*finishing for the lower
handle. Modern and
ergonomic design thanks
to the two rounded handles*

*designed to provide the
greatest ease of use to
obtain soft and precise
stapling with minimum effort.*

CODE	ARTICLE	PACK
0014180	MINI JEWEL TONES PINK FLUO	4
0014181	MINI JEWEL TONES BLUE	4
0014182	MINI JEWEL TONES ORANGE	4
0014183	MINI JEWEL TONES GREEN	4
0014184	MINI JEWEL TONES PURPLE	4
0014185	MINI JEWEL TONES BLACK	4
0014186	MINI JEWEL TONES BLACK/GOLD	4
0099931	DISPLAY PLEXIGLASS MINI JEWEL TONES (15pcs)	1





◀ 15-MINI STAPLER
COUNTERTOP DISPLAY

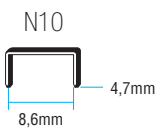

Page 85

N10

Original Maestri staple use recommended



39 mm

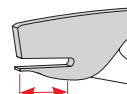

27 mm



12/15



0,13

*Metal body, top loading.
Ideal for office, bank and school.*

EURODESK 50

Antislip base.



Rotating anvil permits closed stapling **A**
open stapling **B**

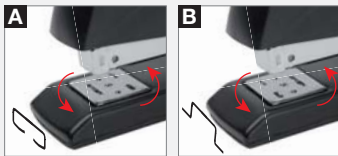

In the open staple position, **B** if needed, it allows staples to be manually removed, thus avoiding permanent sheet stapling (max 5).

Available in:



CODE	ARTICLE	PACK
0031425	EURODESK 50	12

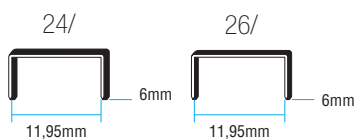

puntofire 126 | 126 GLOBAL

Original Maestri staple use recommended

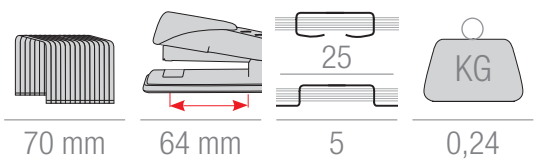

EURODESK 100

CODE	ARTICLE	PACK
0035032	EURODESK 100	12

Antislip base.



Rotating anvil permits closed stapling **A**
open stapling **B**

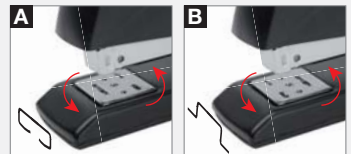

In the open staple position, **B** if needed, it allows staples to be manually removed, thus avoiding permanent sheet stapling (max 5).

Available in:

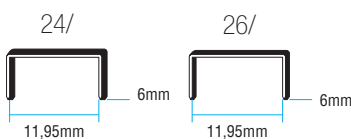

puntoffice 126 | 126 GLOBAL

Original Maestri staple use recommended

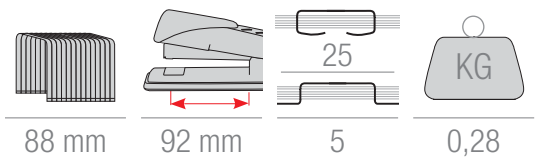

*Metal body, top loading.
Ideal for office, bank
and school.*

EURODESK 200

Antislip base.



Rotating anvil permits
closed stapling **A**
open stapling **B**

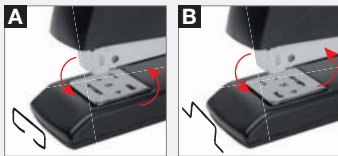

In the open staple position, **B**
if needed, it allows staples to be
manually removed, thus avoiding
permanent sheet stapling (max 5).

Available in:



CODE	ARTICLE	PACK
0035033	EURODESK 200	12

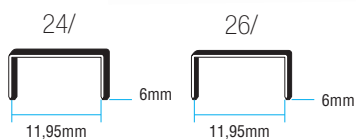

puntofire 126 | 126 GLOBAL

Original Maestri staple use recommended

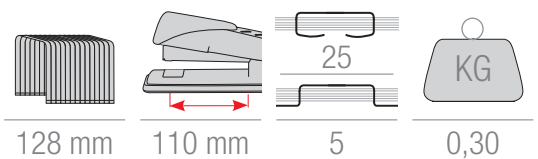

EURODESK 250

CODE	ARTICLE	PACK
0035034	EURODESK 250	6

Antislip base.



Stapling depth adjustment.



Rotating anvil permits closed stapling **A** open stapling **B**

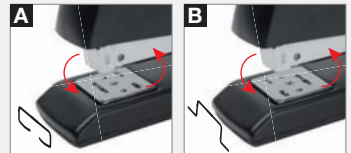

In the open staple position, **B** if needed, it allows staples to be manually removed, thus avoiding permanent sheet stapling (max 5).

Available in:

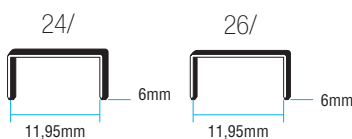

Page 85

puntofiro 126 | 126 GLOBAL

Original Maestri staple use recommended

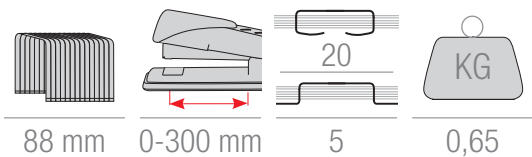

ELY 50

Streamline and pleasing line, plastic body, top loading.

For office, school and bank.

Non-slip feet.



Staple load marker.



Rotating anvil permits closed stapling **A**
open stapling **B**

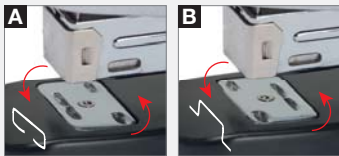

In the open staple position, **B** if needed, it allows staples to be manually removed, thus avoiding permanent sheet stapling (max 5).

Available in:



CODE	ARTICLE	PACK
0031106	ELY 50	12

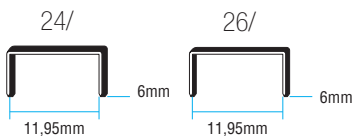

Page 85

puntofire 126 | 126 GLOBAL

Original Maestri staple use recommended

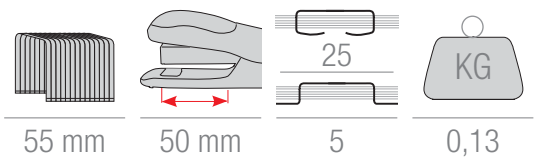

ELY 100

CODE	ARTICLE	PACK
0033113	ELY 100	12

Non-slip feet.



Staple load marker.



Rotating anvil permits closed stapling **A** open stapling **B**

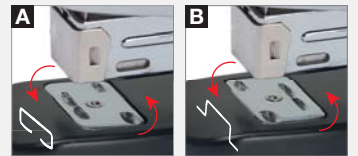

In the open staple position, **B** if needed, it allows staples to be manually removed, thus avoiding permanent sheet stapling (max 5).

Available in:

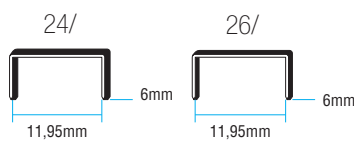

Page 85

puntofiro 126 | 126 GLOBAL

Original Maestri staple use recommended



75 mm

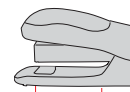

70 mm



5



0,15

ROMALANG 17

Long arm heavy duty staplers for extremely deep and thick stapling. Simple to load, maximum stability.

Easy to use without strain, soft stapling. Used by book binders, print shops, press offices, banks,

law offices, etc. to create brochures, booklets, etc.

Opening front plate for easy staple jam removal.



Stapling depth adjustment.



Available in:



CODE	ARTICLE	PACK
0044103	ROMALANG 10/17	1
0044203	ROMALANG S17	1





**ROMALANG
Mod. 10/17**

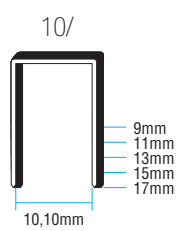

Page 86

**ROMALANG
Mod. S17**

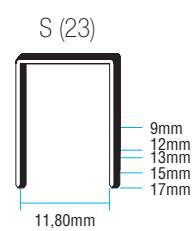

10/ S

Original Maestri staple use recommended

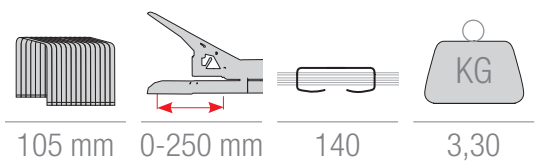

ROMABLOK 17

Professional heavy duty staplers. Simple to load, maximum stability. Easy to use without strain, soft stapling.

Used by book binders, print shops, press offices, banks, law offices, etc.

to create brochures, booklets, etc.

Opening front plate for easy staple jam removal.



Stapling depth adjustment.



Available in:



CODE	ARTICLE	PACK
0043103	ROMABLOK 10/17	1
0043203	ROMABLOK S17	1





**ROMABLOK
Mod. 10/17**

10/

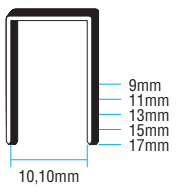

10,10mm

**ROMABLOK
Mod. S17**

S (23)

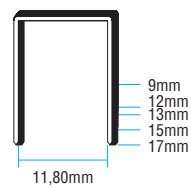

11,80mm

10/ S

Original Maestri staple use recommended

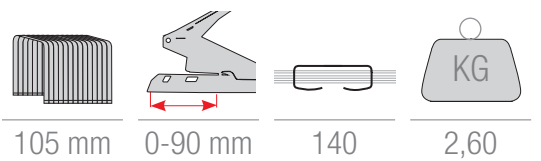

105 mm

0-90 mm

140

2,60

Page 86

ROMABLOK 24

Professional heavy duty staplers. Simple to load, maximum stability.

Easy to use without strain, soft stapling. Used by book binders, print shops, press offices, banks,

law offices, etc. to create brochures, booklets, etc.

Opening front plate for easy staple jam removal.



Stapling depth adjustment.



Available in:



CODE	ARTICLE	PACK
0045105	ROMABLOK 10/24	1
0045205	ROMABLOK S24	1





**ROMABLOK
Mod. 10/24**

10/

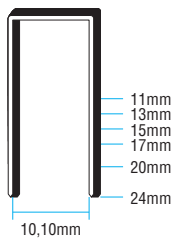

Page 86

**ROMABLOK
Mod. S24**

S (23)

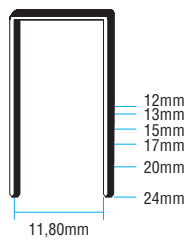

10/ S

Original Maestri staple use recommended

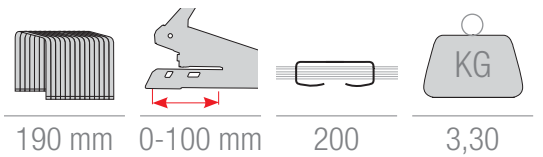

HEAVY DUTY STAPLERS

EUROBLOK 13

Professional heavy duty staplers.
Full metal construction.
Robust and reliable.

Used by book binders, print shops, law offices. Rear loading.

Antislip base.



Stapling depth adjustment.



Available in:



CODE	ARTICLE	PACK
0048104	EUROBLOK 13	1



S (23)

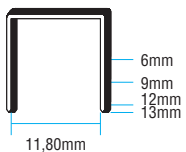

S

Original Maestri staple use recommended

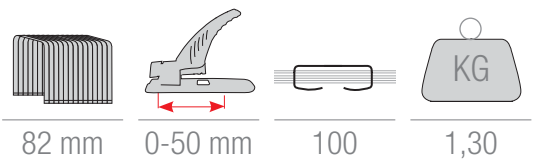

EUROBLOK 24

CODE	ARTICLE	PACK
0048106	EUROBLOK 24	1



Antislip base.



Stapling depth adjustment.



Rotating anvil.



Available in:



S (23)

ANVIL ROTATION

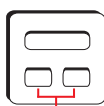
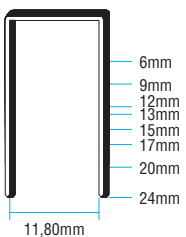

6mm
9mm
12mm
13mm
15mm



17mm
20mm
24mm

S

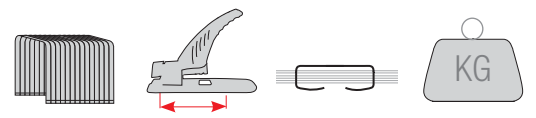

82 mm

0-53 mm

200

1,70

STAPLE REMOVERS

TOP - EUROREMOVER

Practical and modern, with steel spring. Easy removal for all types of office staples, it does not ruin paper.
For office, bank, public office, home, school, DIY.

Full metal construction.



Available in:



CODE	ARTICLE	PACK
0095001	TOP	25
0095037	EUROREMOVER	25
> 0095009	TOP	10
> blister		

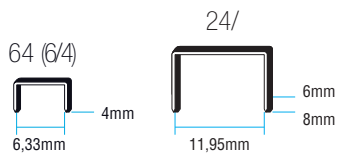

Page 85



Stapling pliers for special applications (e.g. for furriers).

ROMA FUR

CODE	ARTICLE	PACK
> 0090301	ROMA FUR	10
> application for furriers		

Available in:



24/

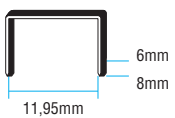

Page 85

puntoffr 126-128 | **126 GLOBAL**

Original Maestri staple use recommended

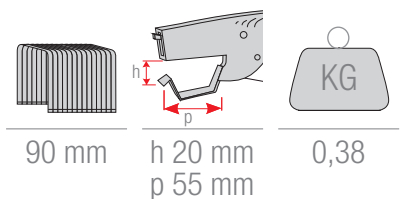

90 mm

h 20 mm
p 55 mm

0,38

EUROPUNCH 21	46
EUROPUNCH 22	47
EUROPUNCH 23	48
EUROPUNCH 24	49
EUROPUNCH 25 2F	50
EUROPUNCH 25 4F	51
EUROPUNCH 4F	52
RO-MA JUMBO	53
ROMA CLIP	54
LABELS	56



PUNCHERS
PAPER CLIPS AND LABELS



EUROPUNCH 21

Practical, elegant, robust, professional punchers, available in different sizes. Metal body.

Ideal to punch all types of paper. For office, school, bank, DIY.

Paper collecting base.



Adjustment square.



Available in:



CODE	ARTICLE	PACK
0096012	EUROPUNCH 21	12



LIGHT DUTY

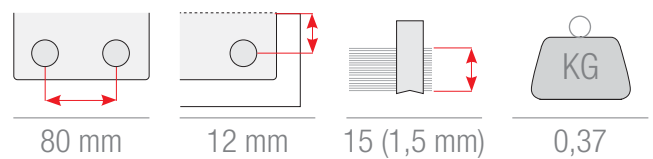

EUROPUNCH 22

CODE	ARTICLE	PACK
0096115	EUROPUNCH 22	12

Paper collecting base.



Adjustment square.



Available in:



LIGHT DUTY

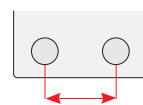

80 mm

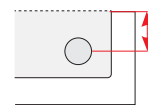

12 mm

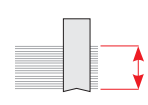

25 (2,5 mm)



0,45

EUROPUNCH 23

Practical, elegant, robust, professional punchers, available for different sizes. Metal body.

Ideal to punch all types of paper. For office, school, bank, DIY.

Paper collecting base.



Adjustment square.



Available in:



CODE	ARTICLE	PACK
0096119	EUROPUNCH 23	12



LIGHT DUTY

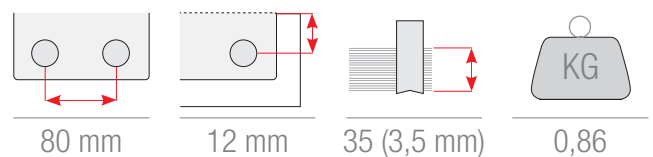

EUROPUNCH 24

CODE	ARTICLE	PACK
0096117	EUROPUNCH 24	12

Paper collecting base.



Adjustment square.



Available in:



HEAVY DUTY

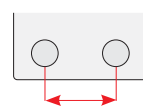

80 mm

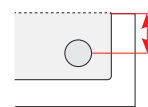

12 mm

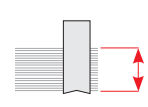

45 (4,5 mm)



0,94

EUROPUNCH 25 2F

Practical, elegant, robust, professional punchers, available for different sizes.

Ideal to punch all types of paper. For office, school, bank, DIY.

Paper collecting base.



Adjustment square.



Rotating disks.



Available in:



CODE	ARTICLE	PACK
0096315	EUROPUNCH 25 2F	12



HEAVY DUTY

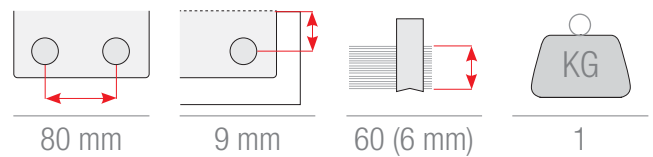

EUROPUNCH 25 4F

CODE	ARTICLE	PACK
0096316	EUROPUNCH 25 4F	6

Paper collecting base.



Adjustment square.



Available in:



HEAVY DUTY

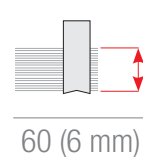
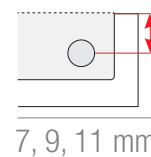
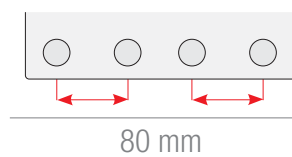

EUROPUNCH 4F

*Elegant, robust,
professional.
Ideal to punch all types of
paper.*

*Metal body. For office,
school, bank, DIY.*

Paper collecting base.



Available in:



CODE	ARTICLE	PACK
0096212	EUROPUNCH 4F	4



LIGHT DUTY

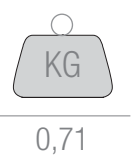
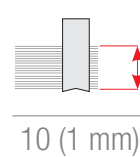
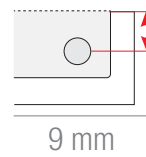
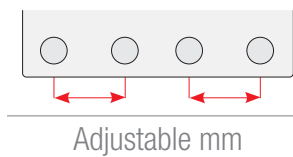

RO-MA JUMBO

Heavy duty puncher. Rear tray for paper waste.
 Extremely robust. Equipped with 2 spare punches and plastic disks.
 Hole diameter: 6 mm.

CODE	ARTICLE	PACK
0096401	RO-MA JUMBO	1

Steel adjustment square.

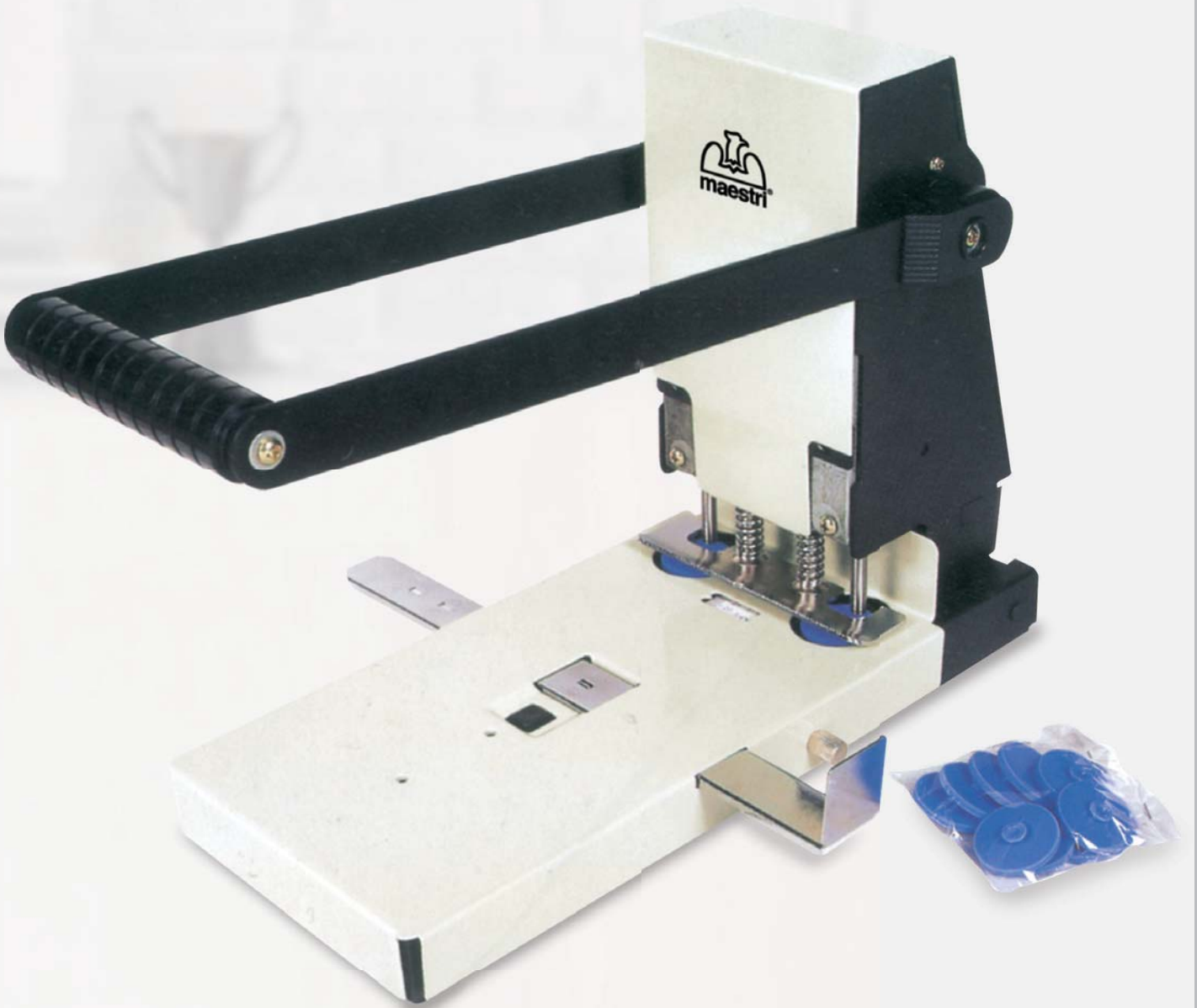

HEAVY DUTY

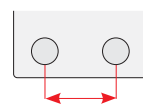

80 mm

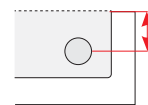

8-18 mm

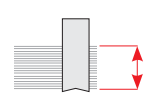

270-280
(28 mm)



5,70





PAPER CLIPS

Strong zinc-plated wire paper clips whose size, combined with excellent raw material quality,

guarantees, excellent sheet hold.

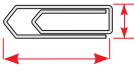
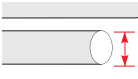
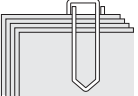
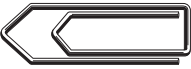
CODE	ARTICLE	PACK
1092102	ROMA CLIP N°2 ZINC-PLATED - 100/1.000	250 (25.000 clips)
1092103	ROMA CLIP N°3 ZINC-PLATED - 100/1.000	250 (25.000 clips)
1092104	ROMA CLIP N°4 ZINC-PLATED - 100/1.000	200 (20.000 clips)
1092105	ROMA CLIP N°5 ZINC-PLATED - 100/1.000	100 (10.000 clips)
1092106	ROMA CLIP N°6 ZINC-PLATED - 100/1.000	100 (10.000 clips)

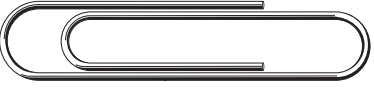

				
		dimensions	wire diameter	max sheet hold
Model ROMA CLIP 2		8x25 mm	Ø 0,8 mm	10
Model ROMA CLIP 3		9x29 mm	Ø 0,9 mm	15
Model ROMA CLIP 4		10x33 mm	Ø 1 mm	20
Model ROMA CLIP 5		10,5x49 mm	Ø 1 mm	25
Model ROMA CLIP 6		11x57 mm	Ø 1,25 mm	30

LABELS

Available colours:



Available in:

100 piece box
A4 sheet format



SELF-ADHESIVE LABELS FOR PRINTERS

Labels suitable for all laser, ink-jet printers and copy machines.

Removable adhesive available permanent.

Specifically designed to eliminate any type of jam. High print quality thanks to high shades of white.

No. LABELS/SHEET	CODE	ARTICLE	PACK	No. LABELS/SHEET	CODE	ARTICLE	PACK	
	1095200	210x297 mm WHITE	10		1095212	105x48 mm WHITE	10	
	1095201	210x297 mm FLUO YELLOW	10			1095266	105x42,4 mm WHITE	10
	1095269	210x297 mm FLUO GREEN	10			1095213	105x40 mm WHITE	10
	1095270	210x297 mm FLUO ORANGE	10			1095214	105x37 mm WHITE	10
	1095205	205x297 mm WHITE	10				1095215	105x36 mm WHITE
	1095202	210x148 mm WHITE	10	1095216	105x35 mm WHITE		10	
	1095203	210x148 mm FLUO YELLOW	10		1095217	105x24 mm WHITE	10	
	1095286	210x148 mm FLUO ORANGE	10			1095218	101x72 mm WHITE	10
	1095203A	210x148 mm FLUO GREEN	10			1095219	101x36 mm WHITE	10
	> 1095206	200x144 mm WHITE	10				> 1095220	99,1x93,1 mm WHITE
	1095204	210x40 mm WHITE	10		> 1095221		99,1x67,7 mm WHITE	10
		> 1095272	185x112 mm WHITE		10		> 1095222	99,1x38,1 mm WHITE
		> 1095267	199,6x289,1 mm WHITE	10			> 1095223	99,1x144 mm WHITE
	> 1095271	196x289 mm WHITE	10	> 1095223D		99,1x144 mm FLUO GREEN	10	
	> 1095207	190x61 mm WHITE	10	> 1095223E		99,1x144 mm FLUO RED	10	
		1095208	105x148 mm WHITE	10		> 1095223F	99,1x144 mm FLUO YELLOW	10
1095208D		105x148 mm FLUO RED	10		> 1095224	99,1x34 mm WHITE	10	
1095208E		105x148 mm FLUO YELLOW	10		1095226	99x34 mm WHITE	10	
	1095209	105x74 mm WHITE	10		> 1095225	99x57 mm WHITE	10	
	1095209D	105x74 mm FLUO GREEN	10					
	1095210	105x72 mm WHITE	10					
	1095211	105x57 mm WHITE	10					

No. LABELS/SHEET	CODE	ARTICLE	PACK	No. LABELS/SHEET	CODE	ARTICLE	PACK	No. LABELS/SHEET	CODE	ARTICLE	PACK
	> 1095273	98x25,4 mm WHITE	10		1095243	68,5x23 mm WHITE	10		> 1095276	47x35 mm WHITE	10
	1095227	97x67,7 mm WHITE	10		1095244	67x36 mm WHITE	10		> 1095256	47,8x25,5 mm WHITE	10
	1095228	97x42,4 mm WHITE	10		1095245	64,6x33,8 mm WHITE	10		1095257	45,2x54,8 mm WHITE	10
	1095229	70x67,7 mm WHITE	10		> 1095246	64x34 mm WHITE	10		1095277	42x25 mm WHITE	10
	1095230	70x50,8 mm WHITE	10		> 1095247	63,5x72 mm WHITE	10		1095258	40x40 mm WHITE	10
	1095231	70x48 mm WHITE	10		> 1095248	63,5x46,6 mm WHITE	10		1095259	38x21,2 mm WHITE	10
	1095232	70x48 mm FLUO ORANGE	10		> 1095249	63,5x38,1 mm WHITE	10		> 1095260	38,1x21,2 mm WHITE	10
	1095233	70x42,4 mm WHITE	10		> 1095249	63,5x38,1 mm WHITE	10		> 1095260	38,1x21,2 mm WHITE	10
	1095234	70x37 mm WHITE	10			1095250	50x36 mm WHITE		10	> 1095262	37,5x23,5 mm WHITE
	1095235	70x36 mm WHITE	10		1095251	52,5x29,7 mm WHITE	10		> 1095278	30x30 mm WHITE	10
	1095236	70x36 mm FLUO ORANGE	10		1095252	52,5x21,21 mm WHITE	10		1095263	25x15 mm WHITE	10
	1095237	70x36 mm FLUO GREEN	10		1095253	51x48 mm WHITE	10		> 1095279	25x10 mm WHITE	10
	1095238	70x35 mm WHITE	10		1095274	52,5x25,4 mm WHITE	10			1095264	ø60 mm ROUND WHITE
	1095268	63,5x33,8 mm WHITE	10	1095254	48,5x25,4 mm WHITE	10		1095265		ø114-ø40 mm ROUND CD WHITE	10
	1095239	70x32 mm WHITE	10		1095275	48x24,75 mm WHITE		10		1095265	ø114-ø40 mm ROUND CD WHITE
	1095240	70x30 mm WHITE	10		1095255	48,5x16,9 mm WHITE	10				
	1095241	70x25,4 mm WHITE	10		1095275	48x24,75 mm WHITE	10				
	1095242	70x10 mm WHITE	10		1095255	48,5x16,9 mm WHITE	10				

> rounded edges



SWING M	60
OPEN	62
LABEL-ROLL	64
INK-ROLL	65







PRICE LABELLERS

Price labellers for label rolls. Ergonomic handle.
 Various models available. Openable compartment for
 Plastic body. easy label roll loading.

CODE	ARTICLE	PACK
0097226	SWING M 1626	1
0097227	SWING M 1426	1
0097232	SWING M 621	1
0097231	SWING M 622	1
0097233	SWING M 821	1
0097234	SWING M 626	1
0097235	SWING M 826	1
0097251	SWING M826 ACCESSORISED/750	1
0097252	SWING M 821 ACCESSORISED/1500	1



SWING M 1626 model Price labellers with 2 lines of print	 26x16 mm	8+8 characters		
SWING M 1426 model Price labellers with 2 lines of print	 26x16 mm	8+6 characters		
SWING M 621 model Price labellers with 1 line of print	 21x12 mm	6 characters		
SWING M 622 model Price labellers with 1 line of print	 22x12 mm	6/8 characters		
SWING M 821 model Price labellers with 1 line of print	 21x12 mm	8 characters		
SWING M 626 model Price labellers with 1 line of print	 26x12 mm	6 characters		
SWING M 826 model Price labellers with 1 line of print	 26x12 mm	8 characters		
SWING M826 ACCESSORISED/750 N°1 Price labeller + n°1 Ink roll + n°10 labels of 750 pcs	 26x12 mm	8 characters		
SWING M821 ACCESSORISED/1500 N°1 Price labeller + n°1 Ink roll + n°4 labels of 1.500 pcs	 21x12 mm	8 characters		

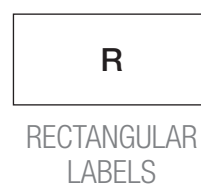

PRICE LABELLERS









Price labellers for label rolls. Ergonomic handle.
Various models available. Openable compartment for
Plastic body. easy label roll loading.

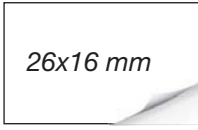

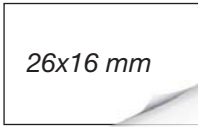
CODE	ARTICLE	PACK
0097225	OPEN S14	1
0097236	OPEN M 6	1
0097237	OPEN TEX	1
0097238	OPEN C20 A	1
0097239	OPEN C8	1

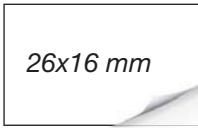

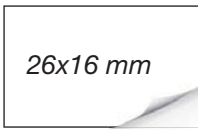

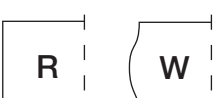
<p>OPEN S14 model Price labellers with 2 lines of print</p>	 <p>26x16 mm</p>	<p>8+8 characters</p>	
<p>OPEN M6 model Price labellers with 1 line of print</p>	 <p>26x16 mm</p>	<p>6 characters</p>	
<p>OPEN TEX model Numerator Mod. 2644 Price labellers with 1 line of print</p>	 <p>26x16 mm</p>	<p>4 fixed characters 4 consecutive characters</p>	
<p>OPEN C20 A model Alphanumerical price labellers with 2 lines of print</p>	 <p>26x16 mm</p>	<p>10+10 characters</p>	
<p>OPEN C8 model Price labellers with 1 line of print</p>	 <p>26x12 mm</p>	<p>8 characters</p>	



RECTANGULAR
LABELS



WAVE
LABELS



LABELS FOR PRICE LABELLERS

Self-adhesive labels removable and specific for
available in various colours, frozen foods.
rectangular and wave shape
with permanent adhesive,

LABELS	CODE	ARTICLE		PACK
W	●●	1095120 26X16w Euro BLUE/YELLOW	36	/1.000 1
W	●	1095301AZ 26X12w Permanent BLUE	36	/1.500 1
R	●	1095376AR 21X12r Permanent FLUO ORANGE	50	/1.000 1
	●	1095376GI 21X12r Permanent FLUO YELLOW	50	/1.000 1
	●	1095376MA 21X12r Permanent FLUO MAGENTA	50	/1.000 1
	●	1095376RO 21X12r Permanent FLUO RED	50	/1.000 1
	●	1095376VE 21X12r Permanent FLUO GREEN	50	/1.000 1
W	●	1095377AR 26X12w Permanent FLUO ORANGE	36	/1.500 1
	●	1095377GI 26X12w Permanent FLUO YELLOW	36	/1.500 1
	●	1095377MA 26X12w Permanent FLUO MAGENTA	36	/1.500 1
	●	1095377RO 26X12w Permanent FLUO RED	36	/1.500 1
	●	1095377VE 26X12w Permanent FLUO GREEN	36	/1.500 1
W	●	1095378AR 26X16w Permanent FLUO ORANGE	36	/1.000 1
	●	1095378GI 26X16w Permanent FLUO YELLOW	36	/1.000 1
	●	1095378MA 26X16w Permanent FLUO MAGENTA	36	/1.000 1
	●	1095378RO 26X16w Permanent FLUO RED	36	/1.000 1
	●	1095378VE 26X16w Permanent FLUO GREEN	36	/1.000 1
R	●	1095379AR 26X16r Permanent FLUO ORANGE	36	/1.000 1
	●	1095379GI 26X16r Permanent FLUO YELLOW	36	/1.000 1
	●	1095379MA 26X16r Permanent FLUO MAGENTA	36	/1.000 1
	●	1095379RO 26X16r Permanent FLUO RED	36	/1.000 1
	●	1095379VE 26X16r Permanent FLUO GREEN	36	/1.000 1
W	●	1095380AR 32X19w Permanent FLUO ORANGE	30	/1.000 1
	●	1095380GI 32X19w Permanent FLUO YELLOW	30	/1.000 1
	●	1095380MA 32X19w Permanent FLUO MAGENTA	30	/1.000 1
	●	1095380RO 32X19w Permanent FLUO RED	30	/1.000 1
	●	1095380VE 32X19w Permanent FLUO GREEN	30	/1.000 1
R	○	1095300 21X12r Permanent WHITE	50	/1.000 1
W	○	1095301 26X12w Permanent WHITE	36	/1.500 1
	●	1095301GI 26X12w Permanent YELLOW	36	/1.500 1
W	○	1095302 26X16w Permanent WHITE	36	/1.000 1
	●	1095302GI 26X16w Permanent YELLOW	36	/1.000 1
R	○	1095303 26X16r Permanent WHITE	36	/1.000 1
W	○	1095304 32X19w Permanent WHITE	30	/1.000 1
R	○	1095326 21X12r Removable WHITE	50	/1.000 1
W	○	1095327 26X12w Removable WHITE	36	/1.500 1
W	○	1095328 26X16w Removable WHITE	36	/1.000 1
R	○	1095329 26X16r Removable WHITE	36	/1.000 1
W	○	1095330 32X19w Removable WHITE	30	/1.000 1
R	○	1095351 21X12r for frozen foods WHITE	50	/1.000 1
W	○	1095352 26X12w for frozen foods WHITE	36	/1.500 1
W	○	1095353 26X16w for frozen foods WHITE	36	/1.000 1
R	○	1095354 26X16r for frozen foods WHITE	36	/1.000 1
W	○	1095355 32X19w for frozen foods WHITE	30	/1.000 1

Roller pads with plastic support. Sponge with "alcohol free" water-based non toxic ink.

CODE	ARTICLE	PACK
1095115	INK ROLL mod. Open	250
1095116	INK ROLL mod. Blitz	250
1095117	INK ROLL mod. Tovel	250
1095118	INK ROLL mod. Jolly	250
1095119	INK ROLL mod. Swing	250
1095121	INK ROLL mod. Open M6	250
1095122	INK ROLL mod. Open Tex	250
1095123	INK ROLL Numerator mod. Open Tex	250

Wide range of roller inking pads

for price labeller model
SWING, OPEN



SWING model page 60 ▲



OPEN model page 62 ▲



LD1	68
SECUR VVB	69
EURO BJ212	70
EURO 701B	71
AL130	72
DORS230	73
BJ05	74
EUROBANK LD60	75
EURO BJ20	76
DP-7011-SE/3D	77
AL5000A	78
BJ6230	79
DP7100 E/3D	80
EURO 270	81
EURO 500	82
EURO 650 8/C	83
CS900S	84





BANKNOTE VERIFIERS

Banknote verifier equipped with bright UV-light, double magnetic sensor to check for the magnetic

wire, double white led to check for watermark and microwriting. Compact size.

Counterfeit check methods:

- UV** ▶ Ultraviolet
- WM** ▶ Watermark check white light
- MG** ▶ Magnetic ink detection

CODE	ARTICLE	PACK
0097140	LD1	1



- 9 Watt UV lamp consumption
- 2 low consumption white led lamps
- MG sensor 2 sensors

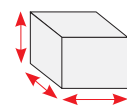

13x10x18 cm

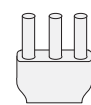

AC220V
50-60 Hz



KG

0,10

SECUR VVB

Banknote verifier equipped with infrared video camera to detect special security inks. The result is displayed on a 4" B/W CRT monitor. Energy and monitor savings circuit with automatic on/off.

CODE	ARTICLE	PACK
0097113	SECUR VVB	1

Counterfeit check methods:

UV ▶ Ultraviolet

IR ▶ Infrared



- 12V input power with separate power supply (supplied)
- UV LED to compare holograms on leading credit cards
- 800x600 pixel resolution monitor

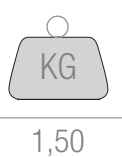
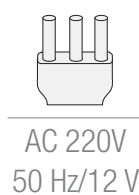
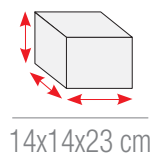

BANKNOTE VERIFIERS

Verifier for all Euro banknotes. Verified total value function. Banknote

insertion in any direction. Front or rear banknote output possibility.

Small size, easy to use, equipped with rechargeable batteries for use during blackouts.

Counterfeit check methods:

- UV** ▶ Ultraviolet
- MG** ▶ Magnetic ink detection
- 2D** ▶ Banknote detection by thickness and dimensions
- IR** ▶ Infrared
- MT** ▶ Security wire detection
- IMAGE** ▶ Image check
- COLOR** ▶ Colour check

UPDATABLE SOFTWARE

CODE	ARTICLE	PACK
0097117	EURO BJ212	1



- Backlit alphanumeric display
- Buzzer in case of suspicious banknote
- 3 hour continuous battery use autonomy
- 0,5 sec counting speed per banknote

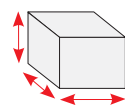

12,5x8,8x5,9 cm



7,2V Ni-Mh
RECHARGEABLE

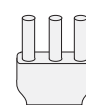

AC240V
50-60 Hz



0,30 battery
not included

EURO 701B

Semi-automatic banknote verifier that quickly and securely checks banknote authenticity.

Value and number of banknotes checked displayed by either their face value or total.

CODE	ARTICLE	PACK
0097141	EURO 701B	1

Counterfeit check methods:

- UV** ▶ Ultraviolet
- MG** ▶ Magnetic ink detection
- 2D** ▶ Banknote detection by thickness and dimensions
- IR** ▶ Infrared
- MT** ▶ Security wire detection

UPDATABLE SOFTWARE



- Backlit alphanumeric display
- Banknote dimension check
- 3 hour continuous battery use autonomy
- 0,5 sec counting speed per banknote

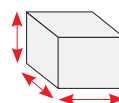

12,4x10x6,9 cm

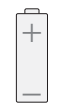

7,4V 650mAH
RECHARGEABLE

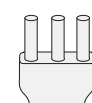

AC240V
50-60 Hz



0,34

BANKNOTE VERIFIERS

Euro banknote verifier, magnetically reads the security wire, magnetic ink, size, colour, infra-red and ultraviolet.

Total verified value function or divided by denomination. Banknote insertion in any direction. Front or rear banknote output possibility.

Small size, easy to use at the till, equipped with rechargeable batteries for use during blackouts (optional function).

Counterfeit check methods:

- IR** ▶ Infrared
- MG** ▶ Magnetic ink detection
- MT** ▶ Security wire detection
- 2D** ▶ Banknote detection by thickness and dimensions
- IMAGE** ▶ Image check
- COLOR** ▶ Colour check

UPDATABLE SOFTWARE

CODE	ARTICLE	PACK
0097142	AL130	1



- Backlit alphanumeric display
- <0.5 sec counting speed per banknote

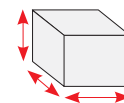

15,5x13,7x8,2 cm

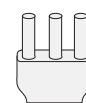

AC 100-240V
50/60Hz



0,45 battery
not included

DORS230

Simple and compact multi-currency verifier. Checks banknotes with automatic recognition, displaying the banknote denomination and currency. All world currencies

in a single model. Includes an innovative patented banknote validation system that uses an image sensor (CIS). Checks the banknote guaranteeing extraordinary reliability.

In fact, it rejects a suspicious banknote, emitting a beep and displaying the type of error. Lift the case to easily clean the sensor and banknote rollers.

CODE	ARTICLE	PACK
0097143	DORS230	1

Counterfeit check methods:

IR ▶ Infrared

UV ▶ Ultraviolet

DD ▶ Banknote height

TRANSPARENCY ▶
Transparency check

UPDATABLE SOFTWARE



- The number of counted banknotes, single or total value are displayed on the screen
- 3.5" colour touch screen
- Back or front output settings for real or suspicious banknotes
- <0.5 sec counting speed per banknote

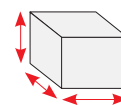

11,5x10,45x8,6 cm

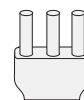

AC 220-240V
50/60Hz



0,550

BANKNOTE COUNTING MACHINES

Rear loading banknote counting machine and verifier. Equipped with dual UV, MG verification

system with the possibility of exclusion for free counting (e.g. food stamps). Lightweight and compact, it

is ideal for anyone who has limited space available. Automatic start, intuitive use and high reliability.

Counterfeit check methods:

UV ▶ Ultraviolet

MG ▶ Magnetic ink detection

CODE	ARTICLE	PACK
0097112	BJ05	1



- 6-digit LCD display
- 850 banknotes per minute counting speed
- Approximately 200 banknote hopper capacity
- Approximately 130 banknote stacker capacity

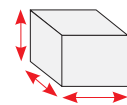

28x22,5x14 cm

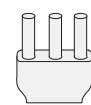

AC230V
50 Hz



4,50

EUROBANK LD60

Versatile banknote counting machine, specifically designed for all applications.

Ideal for high banknote quantity counting.

CODE	ARTICLE	PACK
0097123	EUROBANK LD60	1

Counterfeit check methods:

- DD** ▶ Banknote height
TRANSPARENCY ▶ Transparency check

UPDATABLE SOFTWARE



- 600/1.200/1.500 banknotes per minute counting speed
- Approximately 300 banknote hopper capacity
- Approximately 200 banknote stacker capacity

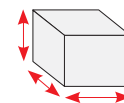

27,2x23,5x23,9 cm

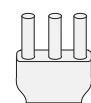

AC230V
50 Hz



7

A professional, intelligent banknote counting machine to count large numbers of banknotes.

Equipped with membrane keypad and two 3 and 4-digit displays with last settings saving systems.

Counterfeit check methods:

- UV** ▶ Ultraviolet
- MG** ▶ Magnetic ink detection
- MT** ▶ Security wire detection
- DD** ▶ Banknote height

CODE	ARTICLE	PACK
0097124	EURO BJ20	1



- Approximately 300 banknote hopper capacity
- Approximately 200 banknote stacker capacity

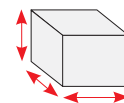

27,2x23,5x23,9 cm

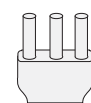

AC230V
50 Hz



7

Intelligent banknote counting machine to count large numbers of banknotes.

Excellent leafing even for worn or small banknotes.

DP-7011-SE/3D

CODE	ARTICLE	PACK
0097134	DP-7011-SE/3D	1



Counterfeit check methods:

- UV** ▶ Ultraviolet
- MG** ▶ Magnetic ink detection
- MT** ▶ Security wire detection
- DOUBLE IR** ▶ Infrared
- COLOR** ▶ Colour check
- 3D** ▶ 3D check

UPDATABLE SOFTWARE

Meets directives:

- ▶ ROHS
- ▶ 2006/42/CE



- 800/1.200/1.500 banknotes per minute counting speed
- Approximately 300 banknote hopper capacity
- Approximately 250 banknote stacker capacity

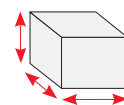

23,5x29x19,5 cm

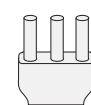

AC230V
50 Hz



6,40



AL5000A

VALUE COUNTING MACHINES

Rear loading value counting machine. Counts, verifies and values the total loaded banknotes. Equipped with control panel. Commands and functions are set with a simple touch, while the side screen lets you read amounts and/or counted banknotes.

Counterfeit check methods:

- MG** ▶ Magnetic ink detection
- UV** ▶ Ultraviolet

UPDATABLE SOFTWARE

Meets directives:

- ▶ ROHS
- ▶ 2006/42/CE



CODE	ARTICLE	PACK
0097135	AL5000A	1



- LED screen
- 1.000 banknotes per minute counting speed
- Approximately 200 banknote hopper capacity
- Approximately 200 banknote stacker capacity

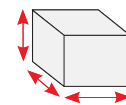

29,2x23,8x17,5 cm

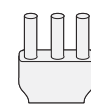

AC 230V
50Hz



5,8

BJ6230

It counts, checks and values mixed banknotes with a triple sensor made up of MT with security code check

and decoding to detect counterfeit banknotes, UV and MG for additional confirmation and IR for

dimensional check.

CODE	ARTICLE	PACK
0097132	BJ6230	1



Counterfeit check methods:

- UV** ▶ Ultraviolet
- MG** ▶ Magnetic ink detection
- MT** ▶ Security wire detection
- 3D** ▶ 3D check
- CIS** ▶ Color Image Sensor
- IR** ▶ Infrared

UPDATABLE SOFTWARE



- 3-digit LCD display
- 1.800 banknote per minute counting speed, with counterfeit check mode up to 1.000
- Approximately 500 banknote hopper capacity
- Approximately 200 banknote stacker capacity

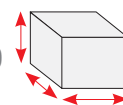

28,7x27,9x25,3 cm

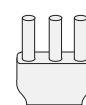

AC230V
50 Hz



8,50



DP7100 E/3D

VALUE COUNTING MACHINES

It counts, verifies and values the total front loaded banknotes.

Equipped with touch screen while the screen displays the wall amount and/or counted notes.

Counterfeit check methods:

- UV** ▶ Ultraviolet
- MG** ▶ Magnetic ink detection
- MT** ▶ Security wire detection
- IR** ▶ Infrared

UPDATABLE SOFTWARE

Meets directives:

- ▶ ROHS
- ▶ 2006/42/CE



CODE	ARTICLE	PACK
0097133	DP7100-E/3D	1



- 1.500 banknote per minute counting speed, with counterfeit check mode up to 1.200
- Approximately 300 banknote hopper capacity
- Approximately 250 banknote stacker capacity

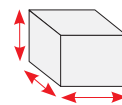

23,5x29x19,5 cm

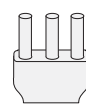

AC230V
50 Hz



6,70

COIN SORTING MACHINES



EURO 270

Reliable and fast coin sorting machine with a compact and modern design. Coins inserted in the machine are counted and sorted into the various trays. A report can be provided at the end of the count for each single denomination and for total coins.

CODE	ARTICLE	PACK
0097150	EURO 270	1



- 7-digit LCD display
- 250 coin per minute counting speed
- Approximately 500 coin hopper capacity
- Approximately 150 coin stacker capacity

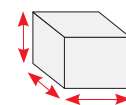

34,5x30,6x26 cm

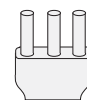

AC220/240V
50-60 Hz



4
KG

COIN SORTING MACHINES

Compact and easy to use coin sorter, with four trays and specifically designed for Euro.

It sorts, counts and stacks in set lots. It displays the value

and number of coins counted for each denomination in a single operation.

CODE	ARTICLE	PACK
0097151	EURO 500	1



- 7-digit LCD display
- 250 coin per minute counting speed
- Approximately 500 coin hopper capacity
- Approximately 250 coin stacker capacity

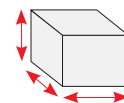

34,5x30,6x26 cm

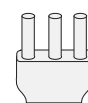

AC220/240V
50-60 Hz



4

Compact and easy to use coin sorter, with eight trays and specifically designed for Euro.

It sorts, counts and stacks in set lots. It displays the value and number of coins counted for each

denomination in a single operation.

EURO 650 8/C

CODE	ARTICLE	PACK
0097152	EURO 650 8/C	1



- 7-digit LCD display
- 650 coin per minute counting speed
- Approximately 500 coin hopper capacity
- Approximately 400 coin stacker capacity

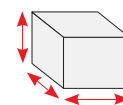

30,2x27,8x25,8 cm

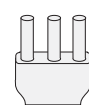

AC220V
50 Hz



5

COIN SORTING MACHINES

Highly professional with LCD display. Ideal product to fully manage coin counting

and sorting for up to 8 denominations. Lot counting, single coin, memory and

coin value functions. Ideal for all those who handle large amounts of coins.

CODE	ARTICLE	PACK
0097153	CS900S	1



- >600 coin per minute counting speed
- Approximately 3.600 coin hopper capacity
- Equipped with coin rejection tray for unrecognised coins

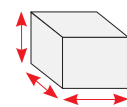

75x35x50 cm

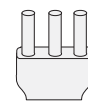

AC220V
50 Hz



35

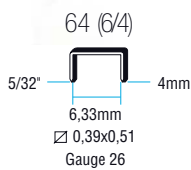

CODE	ARTICLE	PACK
1001121	JOLLY ORO - 1.000/10.000	500.000
1001131	JOLLY ORO - 2.000/10.000	500.000
1001101	64 ORO - 2.000/20.000	500.000
1001310	64 GLOBAL - 1.000/10.000	500.000
1001403	64 LUCIDI - 2.000/20.000	500.000
> 1010025	JOLLY ORO - 4 x 1.000	20
> blister		
PAGE		
4	5	10 14 16 17 18 21
42		

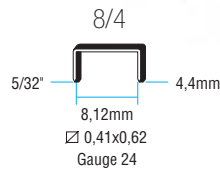

CODE	ARTICLE	PACK
1002301	8/4 - 1.000/10.000	500.000
PAGE		
6	11	15 19

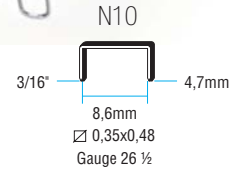

CODE	ARTICLE	PACK
1002101	N 10 - 1.000/10.000	250.000
PAGE		
7	12	15 23 25 27

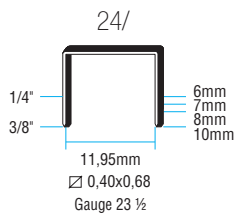

CODE	ARTICLE	PACK
1003103	126 ORO - 1.000/10.000	250.000
1003105	126 GLOBAL - 1.000/10.000	250.000
1003404	127 LUCIDI - 10.000	250.000
1003601	128 ORO - 2.000/10.000	250.000
1003610	1210 GLOBAL - 2.000/10.000	200.000
> 1010311	126 ORO - 2 x 1.000	20
> blister		
PAGE		
8	13	28 29 30 31 32 33
42	43	

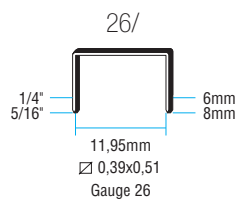

PAGE						
13	28	29	30	31	32	33

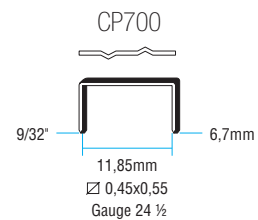

CODE	ARTICLE	PACK
1003932	CP700 UNDULATED - 5.000	500.000
PAGE		
9		

OFFICE

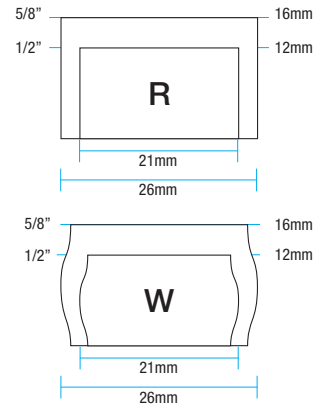
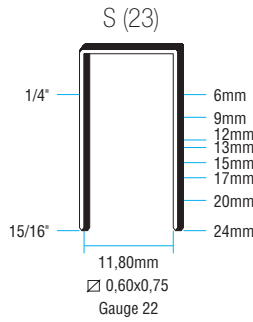
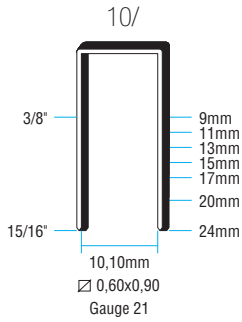

CODE	ARTICLE	PACK
1005101	10/9 STEEL - 5.000	75.000
1005103	10/11 STEEL - 5.000	65.000
1005105	10/13 STEEL - 5.000	55.000
1005107	10/15 STEEL - 5.000	50.000
1005109	10/17 STEEL - 2.000	44.000
1005111	10/20 STEEL - 2.000	40.000
1005113	10/24 STEEL - 2.000	26.000

PAGE		
35	37	39

CODE	ARTICLE	PACK
1005400	S6 STEEL - 1.000/10.000	100.000
1005415	S9 STEEL - 1.000/10.000	100.000
1005416	S12 STEEL - 1.000/10.000	100.000
1005417	S15 STEEL - 1.000	40.000
1005418	S17 STEEL - 1.000	34.000
1005419	S20 STEEL - 1.000	30.000
1005420	S24 STEEL - 1.000	26.000
1010410	S KIT - 25.000	1

PAGE				
35	37	39	40	41

PAGE		
61	63	64

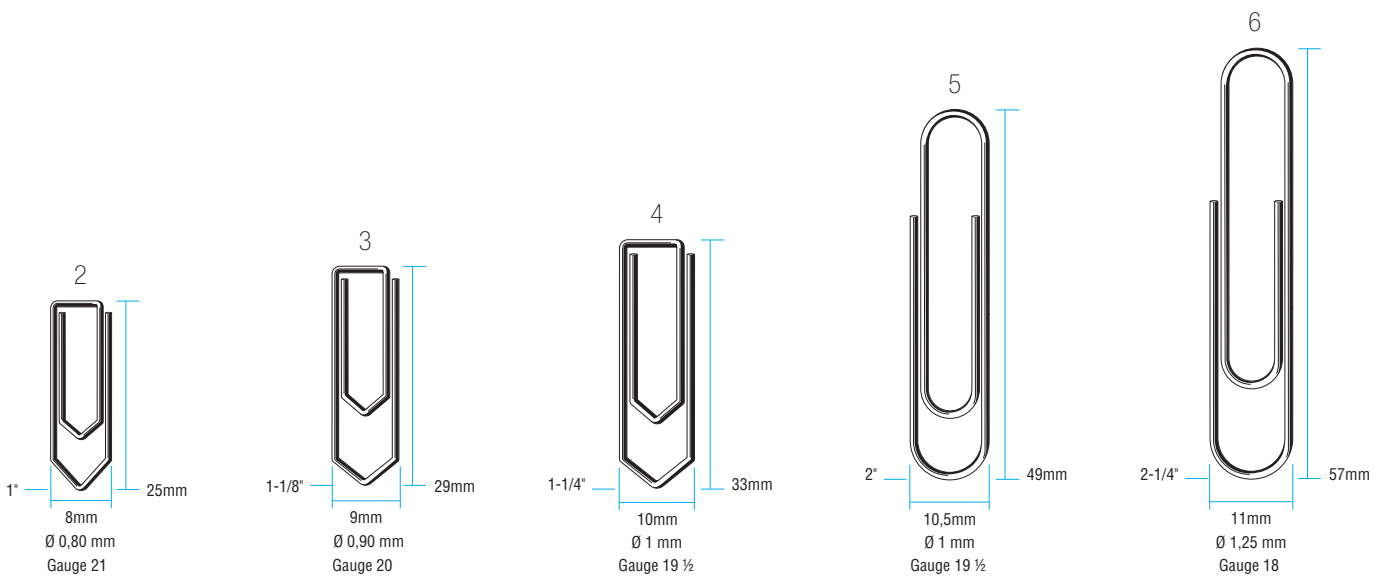

PAGE		
55		

CROSS REFERENCE TABLE



STAPLES	ISABERG RAPID ESSELTE	LEBEZ	LEITZ	MAX	NOVUS	OMER	ZENITH
<p>jolly® punto universale oro puntoffro 64 64 GLOBAL 64</p> <p>64 (6/4) 4mm 6.33mm</p>	21 - 51	P11	N8		7/45 - 111		130E - Z6
<p>8/4</p> <p>8/4 4.4mm 8.12mm</p>	JAKY 8/4 BèBè				8/4		
<p>N10</p> <p>N10 4.7mm 8.6mm</p>	N10 - 10/4	P10	N10	N10 - 1M	N10		
<p>puntoffro 126 126 GLOBAL puntoffro 128 1210 GLOBAL</p> <p>24/ 6mm 7mm 8mm 10mm 11.95mm</p>	24	24	24 - 25	N3 - 1M	24		515 - 115Z
<p>26/</p> <p>26/ 6mm 8mm 11.95mm</p>	26 - 66					26	512 - 112Z
<p>CP700</p> <p>CP700 6.7mm 11.85mm</p>	41						
<p>10/</p> <p>10/ 9mm 11mm 13mm 15mm 17mm 20mm 24mm 10.10mm</p>							
<p>S (23)</p> <p>S (23) 6mm 9mm 12mm 13mm 15mm 17mm 20mm 24mm 11.80mm</p>	S 9 - 23	KH23	23	12FA - H	23		



Fastening Systems since 1919



romeo maestri & figli s.p.a.

sistemi di cucitura a punto metallico - stapling systems manufacturer

via Milano, 5 - 20010 Cornaredo (Mi) - Italy
tel +39 02.93619.1 - fax +39 02.93619.222

www.romeomaestri.com
sales@romeomaestri.it

