



CATÁLOGO GENERAL 

 Office Line



Cuatro generaciones, un sólido pasado y
mucho experiencia madurada.

Aquí estamos, con la pasión de siempre,
diseñando el futuro.

Elio y Eliana Maestri

Office Line



GRAPADORAS DE PINZA

PRIMULA 6	4
PRIMULA 6/2	5
PRIMULA 8	6
PRIMULA 10	7
PRIMULA 12	8
PRIMULA 700	9
EUROPLIER 6	10
EUROPLIER 8	11
EUROPLIER 10	12
EUROPLIER 12	13
EUROSUPER 6	14
EUROSUPER 8-10	15
PARVA 1	16
PARVA 2	17
PARVETTA 6	18
PARVETTA 8	19
PUNCAR SUPER	20
MINI	22
MINI CANDY COLOR	24
MINI JEWEL TONES	26

GRAPADORAS DE MESA

EURODESK 50	28
EURODESK 100	29
EURODESK 200	30
EURODESK 250	31
ELY 50	32
ELY 100	33

GRAPADORAS PARA ALTOS ESPESORES

ROMALANG 17	34
ROMABLOK 17	36
ROMABLOK 24	38
EUROBLOK 13	40
EUROBLOK 24	41

QUITAGRAPAS

TOP - EUROREMOVER	42
-------------------	----

APARATOS ESPECIALES

ROMA FUR	43
----------	----



TALADRADORAS

EUROPUNCH 21	46
EUROPUNCH 22	47
EUROPUNCH 23	48
EUROPUNCH 24	49
EUROPUNCH 25 2F	50
EUROPUNCH 25 4F	51
EUROPUNCH 4F	52
RO-MA JUMBO	53

CLIPS

ROMA CLIP	54
-----------	----

ETIQUETAS AUTOADHESIVAS

PARA IMPRESORAS

LABELS	56
--------	----



ETIQUETADORAS DE PRECIOS

SWING M	60
OPEN	62
LABEL-ROLL	64
INK-ROLL	65



COMPROBADORES DE BILLETES

LD1	68
SECUR VVB	69
EURO BJ212	70
EURO 701B	71
AL130	72
DORS230	73

CONTADORES DE BILLETES

BJ05	74
EUROBANK LD60	75
EURO BJ20	76
DP-7011-SE/3D	77

VALORADORAS DE BILLETES

AL5000A	78
BJ6230	79
DP7100 E/3D	80

CONTADORES SEPARADORES DE MONEDAS

EURO 270	81
EURO 500	82
EURO 650 8/C	83
CS900S	84

Consumables

OFFICE	85
--------	----

PRIMULA 6	4
PRIMULA 6/2	5
PRIMULA 8	6
PRIMULA 10	7
PRIMULA 12	8
PRIMULA 700	9
EUROPLIER 6	10
EUROPLIER 8	11
EUROPLIER 10	12
EUROPLIER 12	13
EUROSUPER 6	14
EUROSUPER 8-10	15
PARVA 1	16
PARVA 2	17
PARVETTA 6	18
PARVETTA 8	19
PUNCAR SUPER	20
MINI	22
MINI CANDY COLOR	24
MINI JEWEL TONES	26
EURODESK 50	28
EURODESK 100	29
EURODESK 200	30
EURODESK 250	31
ELY 50	32
ELY 100	33
ROMALANG 17	34
ROMABLOK 17	36
ROMABLOK 24	38
EUROBLOK 13	40
EUROBLOK 24	41
TOP-EUROREMOVER	42
ROMA FUR	43







PRIMULA 6

GRAPADORAS DE PINZA

Moderna y ergonómica. Indicador de carga de Grapado suave y silencioso. Cobertura frontal personalizable.

Carga posterior. Ideal para la oficina, la escuela, para casa y manualidades.

Colores disponibles:



Cobertura de plástico personalizable.



Disponible en:



CÓDIGO	ARTÍCULO	PACK
0000107	PRIMULA 6 PENTACOLOR	25
> 0000217	PRIMULA 6 PENTACOLOR	10
> blister		

ANTIBLOCK system

Sistema de desatasco automático de la grapa



1.000 grapas ▶ INCLUIDAS

64 (6/4)

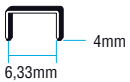

jolly | **puntooro 64** | **64 GLOBAL** | **64**

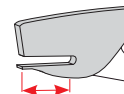

Para todas las grapas de paso 6 Se aconseja el uso de grapas originales Maestri
Pág. 85

80 mm

46 mm

10/12

0,23

PRIMULA 6/2

CÓDIGO	ARTÍCULO	PACK
0000412	PRIMULA 6/2 PENTACOLOR	25

ANTIBLOCK system

Sistema de desatasco automático de la grapa

Colores disponibles:



Cobertura de plástico personalizable.



Base giratoria que permite la grapa cerrada **A** grapa abierta **B**

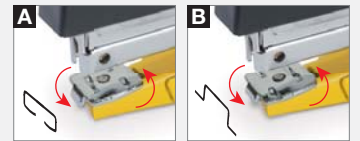

En la posición de grapa abierta **B** permite, si fuese necesario, retirar la grapa manualmente, evitando así el grapado permanente de los folios (máx. 3).



Disponible en:



64 (6/4)

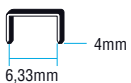

jolly® puntoafro 64 | 64 GLOBAL | 64



80 mm

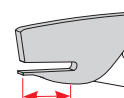

46 mm



2/3



0,21

Para todas las grapas de paso 6
Pág. 85

Se aconseja el uso de grapas originales Maestri

PRIMULA 8

GRAPADORAS DE PINZA

Moderna y ergonómica.
Grapado suave y silencioso.
Cobertura frontal
personalizable.

Indicador de carga de
grapas. Carga posterior.
Ideal para la oficina, la
escuela, para casa y

manualidades.

Colores disponibles:



Cobertura de plástico
personalizable.



Disponible en:



CÓDIGO	ARTÍCULO	PACK
0011002	PRIMULA 8 PENTACOLOR	25

ANTIBLOCK system

Sistema de desatasco
automático de la grapa



8/4

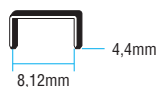

8/4

Para todas las grapas de paso 8
Pág. 85

Se aconseja el uso de grapas originales Maestri



80 mm

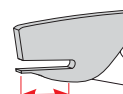

46 mm



10/12



0,21

CÓDIGO	ARTÍCULO	PACK
0014002	PRIMULA 10 PENTACOLOR	25

ANTIBLOCK system

Sistema de desatasco automático de la grapa

Colores disponibles:



Cobertura de plástico personalizable.



Disponible en:



N10

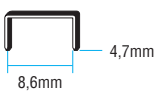

N10

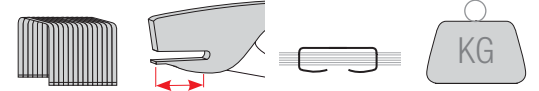

80 mm

46 mm

10/12

0,21

Para todas las grapas de paso 10
Pág. 85

Se aconseja el uso de grapas originales Maestri

PRIMULA 12

Sólida, manejable, profesional, con cobertura frontal personalizable. Cuerpo de metal.

Carga posterior. Ideal para el grapado de espesores ligeramente más levados, muy utilizada en tiendas,

supermercados, almacenes, laboratorios, floristas, etc.

Indicador de carga de grapas.



Cobertura de plástico personalizable.



Disponible en:



CÓDIGO	ARTÍCULO	PACK
0022003	PRIMULA 12	10
> 0022057	PRIMULA 12	8
> blister		



400 grapas ▶ INCLUIDAS

24/

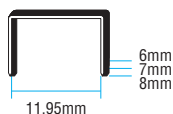

puntoffice 126-128 | 126 GLOBAL

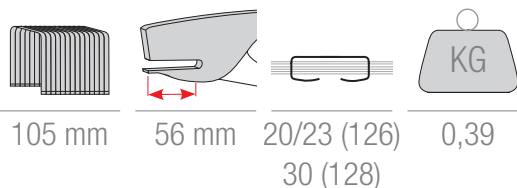

Para todas las grapas de paso 12
Pág. 85

Se aconseja el uso de grapas originales Maestri

PRIMULA 700

Diseñada para aplicaciones especiales con grapas onduladas, ideal para tintorerías y lavanderías.

CÓDIGO	ARTÍCULO	PACK
0022501	PRIMULA 700	10



Indicador de carga de grapas.



Cobertura de plástico personalizable.



Disponible en:



Para grapas onduladas ▶



CP700

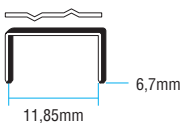

CP700

Para todas las grapas onduladas
Pág. 85

Se aconseja el uso de grapas originales Maestri

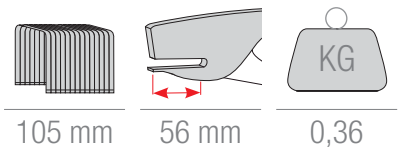

GRAPADORAS DE PINZA

Elegantes, de diseño ergonómico, con manillas redondeadas diseñadas para la máxima facilidad

de uso y para obtener un grapado suave y preciso con el mínimo esfuerzo. Completamente fabricadas

con componentes de metal laminado con dos acabados: parte superior lacada y parte inferior brillante.

Disponible en:



CÓDIGO	ARTÍCULO	PACK
0001401	EUROPLIER 6	25

ANTIBLOCK system

Sistema de desatasco automático de la grapa



1.000 grapas ▶ INCLUIDAS

64 (6/4)

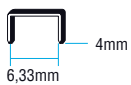

jolly | **puntofino 64** | **64 GLOBAL** | **64**

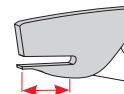

Para todas las grapas de paso 6 Se aconseja el uso de grapas originales Maestri
Pág. 85

80 mm

45 mm

10/12

0,26

EUROPLIER 8

CÓDIGO	ARTÍCULO	PACK
0011201	EUROPLIER 8	25

Disponible en:



ANTIBLOCK system

Sistema de desatasco automático de la grapa

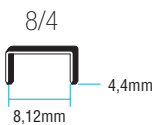

8/4

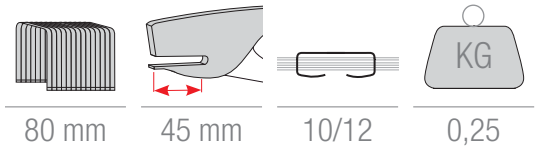

Para todas las grapas de paso 8
Pág. 85

Se aconseja el uso de grapas originales Maestri

EUROPLIER 10

Elegantes, de diseño ergonómico, con manillas redondeadas diseñadas para la máxima facilidad

de uso y para obtener un grapado suave y preciso con el mínimo esfuerzo. Completamente fabricadas

con componentes de metal laminado con dos acabados: parte superior lacada y parte inferior brillante.

Disponible en:



CÓDIGO	ARTÍCULO	PACK
0014220	EUROPLIER 10	25

ANTIBLOCK system

Sistema de desatasco automático de la grapa



N10

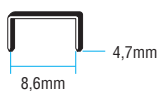

N10

Para todas las grapas de paso 10
Pág. 85

Se aconseja el uso de grapas originales Maestri



80 mm

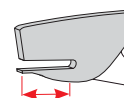

45 mm



10/12



0,25

Diseñada para grapados de gran espesor.

EUROPLIER 12

CÓDIGO	ARTÍCULO	PACK
0022401	EUROPLIER 12	10

Base giratoria que permite la grapa cerrada **A** grapa abierta **B**

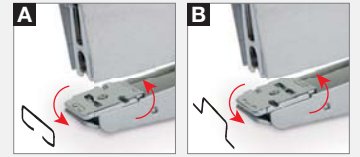

En la posición de grapa abierta **B** permite, si fuese necesario, retirar la grapa manualmente, evitando así el grapado permanente de los folios (máx. 5).

Disponible en:

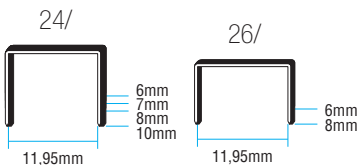

puntoGro 126-128 126-1210 GLOBAL



90 mm

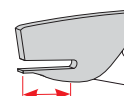

55 mm

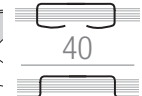

5



0,38

Para todas las grapas de paso 12
Pág. 85

Se aconseja el uso de grapas originales Maestri

GRAPADORAS DE PINZA

Las amplias superficies de agarre, las formas redondeadas, el perfil de las dos asas, la

suavidad durante el grapado, convierten a la serie Eurosuper en la preferida por su ergonomía y facilidad de uso.

Colores disponibles:



Carga frontal con apertura con botón.



Disponible en:



CÓDIGO	ARTÍCULO	PACK
0006055	EUROSUPER 6	20



64 (6/4)

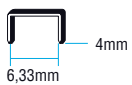

jolly | **puntofiro 64** | **64 GLOBAL** | **64**



57 mm

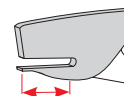

41 mm



10/12



0,28

Para todas las grapas de paso 6
Pág. 85

Se aconseja el uso de grapas originales Maestri

EUROSUPER 8-10

CÓDIGO	ARTÍCULO	PACK
0011235	EUROSUPER 8-10	20



Colores disponibles:



Carga frontal con apertura con botón.



Disponible en:

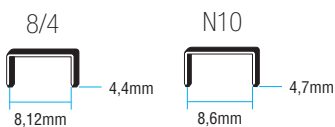

Para todas las grapas de paso 6
Pág. 85

8/4 | N10

Se aconseja el uso de grapas originales Maestri



57 mm

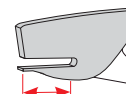

41 mm



10/12



0,29 KG

PARVA 1

GRAPADORAS DE PINZA

La más tradicional y famosa de las grapadoras de pinza. Robusta y elegante. Máxima profundidad de grapado.

Completamente de metal, carga posterior. Esencial para la oficina, para casa, para la empresa y en la escuela.

Colores disponibles:



Disponible en:



CÓDIGO	ARTÍCULO	PACK
0002170	PARVA 1	25



64 (6/4)

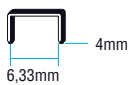

jolly | **puntofiro 64** | **64 GLOBAL** | **64**
punto universale oro

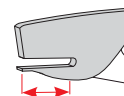

72 mm

56 mm

10/12

0,24

Para todas las grapas de paso 6
 Pág. 85

Se aconseja el uso de grapas originales Maestri

PARVA 2

CÓDIGO	ARTÍCULO	PACK
0002220	PARVA 2	25

Colores disponibles:



Base giratoria que permite la grapa cerrada **A**
grapa abierta **B**

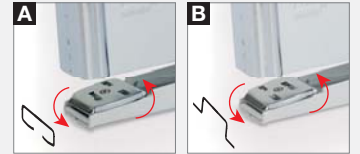

En la posición de grapa abierta **B** permite, si fuese necesario, retirar la grapa manualmente, evitando así el grapado permanente de los folios (máx. 3).

Disponible en:



64 (6/4)

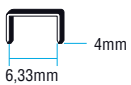

jolly | **puntofiro 64** | **64 GLOBAL** | **64**



72 mm

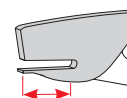

56 mm



2/3



0,24

Para todas las grapas de paso 6
Pág. 85

Se aconseja el uso de grapas originales Maestri



PARVETTA 6

GRAPADORAS DE PINZA

Grapadoras de pinza para la oficina fabricadas íntegramente con componentes de metal

laminado de alta calidad. Diseño moderno y atractivo, con la parte superior lacada y la parte inferior brillante.

Carga posterior.

Colores disponibles:



Etiqueta personalizable.



Disponible en:



CÓDIGO	ARTÍCULO	PACK
0000050	PARVETTA 6	20



1.000 grapas INCLUIDAS



64 (6/4)

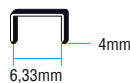

jolly punto universal oro | **puntoafino 64** | **64 GLOBAL** | **64**



85 mm

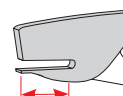

42 mm



10/12



0,24

Para todas las grapas de paso 6 Se aconseja el uso de grapas originales Maestri
Pág. 85

PARVETTA 8

CÓDIGO	ARTÍCULO	PACK
0011045	PARVETTA 8	20

Colores disponibles:



Etiqueta personalizable.



Disponible en:



8/4

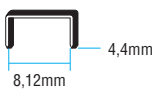

8/4



85 mm

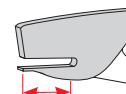

42 mm



10/12



0,24

Para todas las grapas de paso 8
Pág. 85

Se aconseja el uso de grapas originales Maestri



GRAPADORAS DE PINZA

PUNCAR SUPER

Grapadora con un diseño exquisitamente elegante. Robusta, ergonómica, ligera, con manilla superior

fabricada en aleación de aluminio. Para su uso en la oficina, en casa y en la escuela.

Colores disponibles:



Carga frontal con apertura con botón.



El remachador permite grapa cerrada **A** grapa abierta **B**

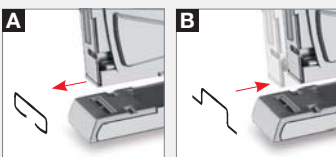

La solución **Sliding System**, en la posición de grapa abierta **B** permite, si fuese necesario, retirar la grapa manualmente, evitando así el grapado permanente de los folios (máx. 3).

CÓDIGO	ARTÍCULO	PACK
0099260	PUNCAR SUPER	1



Disponible en:



1.000 grapas ▶ INCLUIDAS





▲ EXPOSITOR DE BANCO DE 10 GRAPADORAS

64 (6/4)

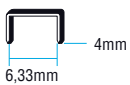

jolly | **puntofiro 64** | **64 GLOBAL** | **64**



55 mm

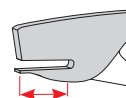

52 mm



2/3



0,31

Para todas las grapas de paso 6 Se aconseja el uso de grapas originales Maestri
 Pág. 85

GRAPADORAS DE PINZA

Grapadora de pinza mini para la oficina fabricadas íntegramente con componentes de

metal laminado de alta calidad. Diseño moderno y ergonómico gracias a sus dos manillas redondeadas

diseñadas para la máxima facilidad de uso y para obtener un grapado suave y preciso con el mínimo esfuerzo.

Colores disponibles:



Disponible en:



CÓDIGO	ARTÍCULO	PACK
0014176	MINI	1



1.000 grapas ▶
INCLUIDAS





▲ EXPOSITOR DE BANCO DE 20 GRAPADORAS MINI

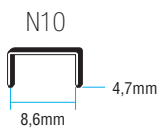

Para todas las grapas de paso 10
Pág. 85

N10

Se aconseja el uso de grapas originales Maestri

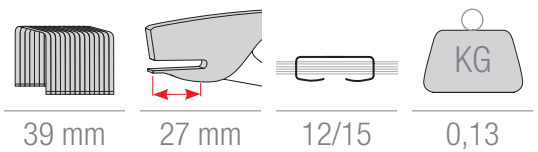



MINI CANDY COLOR

Colores disponibles:



Disponible en:

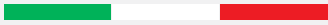

A DIFFERENT
maestri[®]
TOUCH

MADE in ITALY

GRAPADORAS DE PINZA

Mini grapadora de alicates para oficina con doble efecto de pintura glitter. Precioso acabado en cromo satinado

del mango inferior. Diseño moderno y ergonómico gracias a sus dos manillas redondeadas diseñadas para

la máxima facilidad de uso y para obtener un grapado suave y preciso con el mínimo esfuerzo.

CÓDIGO	ARTÍCULO	PACK
0014190	MINI CANDY COLOR PINK	4
0014191	MINI CANDY COLOR YELLOW	4
0014192	MINI CANDY COLOR BLUE	4
0014193	MINI CANDY COLOR LIGHT BLUE	4
0014194	MINI CANDY COLOR GREEN	4
0099932	DISPLAY PLEXIGLASS MINI CANDY COLOR (15pcs)	1





◀ EXPOSITOR DE BANCO DE 15 GRAPADORAS MINI



N10

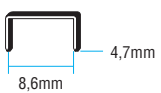

N10

Para todas las grapas de paso 10
Pág. 85

Se aconseja el uso de grapas originales Maestri

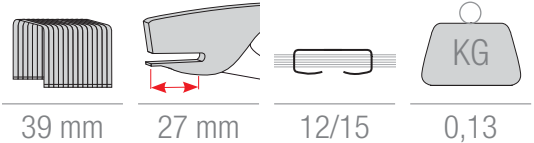

39 mm

27 mm

12/15

0,13



MINI JEWEL TONES

Colores disponibles:



Disponible en:

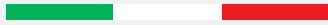

A DIFFERENT
maestri[®]
TOUCH

MADE in ITALY

GRAPADORAS DE PINZA

Mini grapadora para oficina acabada con un elegante y refinado terciopelo de color. Precioso acabado en cromo satinado del mango

inferior. Diseño moderno y ergonómico gracias a sus dos manillas redondeadas diseñadas para la máxima facilidad de uso y para

obtener un grapado suave y preciso con el mínimo esfuerzo.

CÓDIGO	ARTÍCULO	PACK
0014180	MINI JEWEL TONES PINK FLUO	4
0014181	MINI JEWEL TONES BLUE	4
0014182	MINI JEWEL TONES ORANGE	4
0014183	MINI JEWEL TONES GREEN	4
0014184	MINI JEWEL TONES PURPLE	4
0014185	MINI JEWEL TONES BLACK	4
0014186	MINI JEWEL TONES BLACK/GOLD	4
0099931	DISPLAY PLEXIGLASS MINI JEWEL TONES (15pcs)	1





◀ EXPOSITOR DE BANCO DE 15 GRAPADORAS MINI



N10

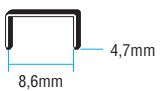

Para todas las grapas de paso 10
Pág. 85

N10

Se aconseja el uso de grapas originales Maestri



39 mm

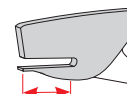

27 mm



12/15



0,13

EURODESK 50

Cuerpo de metal, carga superior.
Ideal para oficinas, bancos y escuelas.

Base antideslizante.



Base giratoria que permite la grapa cerrada **A** grapa abierta **B**

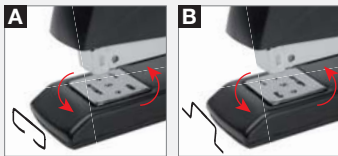

En la posición de grapa abierta **B** permite, si fuese necesario, retirar la grapa manualmente, evitando así el grapado permanente de los folios (máx. 5).

Disponible en:



CÓDIGO	ARTÍCULO	PACK
0031425	EURODESK 50	12

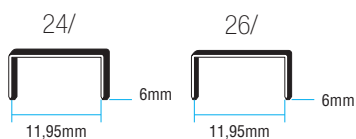

Para todas las grapas de paso 12
Pág. 85

puntoffice 126 | 126 GLOBAL

Se aconseja el uso de grapas originales Maestri

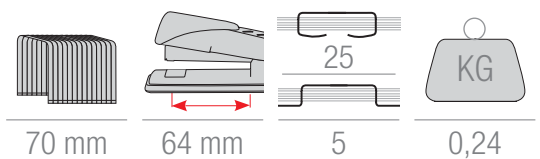

EURODESK 100

CÓDIGO	ARTÍCULO	PACK
0035032	EURODESK 100	12

Base antideslizante.



Base giratoria que permite la grapa cerrada **A**
grapa abierta **B**

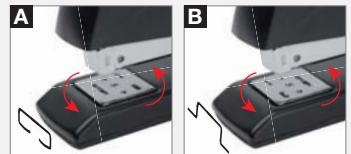

En la posición de grapa abierta **B** permite, si fuese necesario, retirar la grapa manualmente, evitando así el grapado permanente de los folios (máx. 5).

Disponible en:

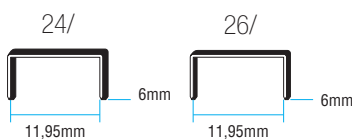

Para todas las grapas de paso 12
Pág. 85

puntofiro 126 | 126 GLOBAL

Se aconseja el uso de grapas originales Maestri

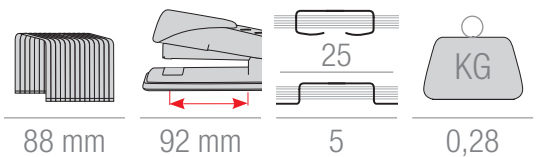

EURODESK 200

Cuerpo de metal, carga superior.
Ideal para oficinas, bancos y escuelas.

Base antideslizante.



Base giratoria que permite la grapa cerrada **A**
grapa abierta **B**

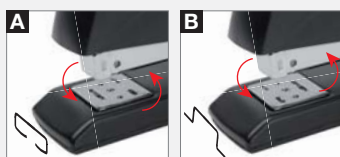

En la posición de grapa abierta **B** permite, si fuese necesario, retirar la grapa manualmente, evitando así el grapado permanente de los folios (máx. 5).

Disponible en:



CÓDIGO	ARTÍCULO	PACK
0035033	EURODESK 200	12

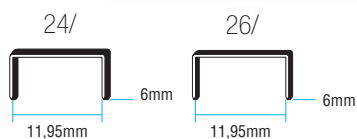

Para todas las grapas de paso 12
Pág. 85

puntoffice 126 | 126 GLOBAL

Se aconseja el uso de grapas originales Maestri

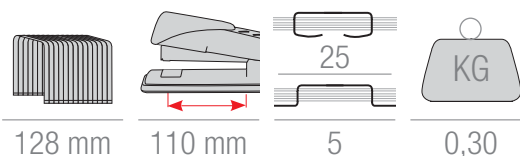

CÓDIGO	ARTÍCULO	PACK
0035034	EURODESK 250	6

Base antideslizante.



Regulación de la profundidad de grapado.



Base giratoria que permite la grapa cerrada **A** grapa abierta **B**

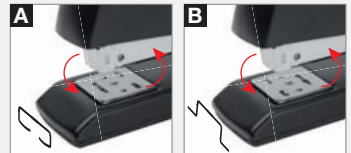

En la posición de grapa abierta **B** permite, si fuese necesario, retirar la grapa manualmente, evitando así el grapado permanente de los folios (máx. 5).

Disponible en:

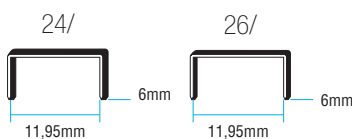

Para todas las grapas de paso 12
Pág. 85

puntofiro 126 | 126 GLOBAL

Se aconseja el uso de grapas originales Maestri

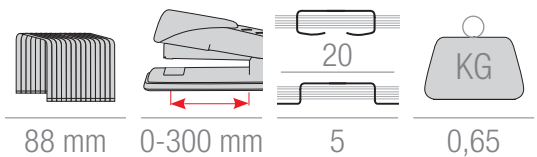

ELY 50

Línea sobria y agradable,
cuerpo de plástico,
carga superior.

Para la oficina, la escuela
y para bancos.

Patas antideslizantes.



Indicador de carga de grapas.



Base giratoria que permite la
grapa cerrada **A**
grapa abierta **B**

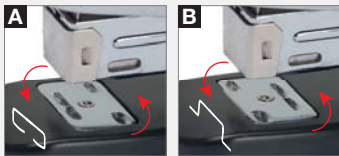

En la posición de grapa abierta **B**
permite, si fuese necesario, retirar
la grapa manualmente, evitando así
el grapado permanente de los folios
(máx. 5).

Disponible en:



CÓDIGO	ARTÍCULO	PACK
0031106	ELY 50	12

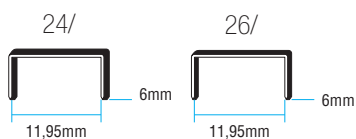

Para todas las grapas de paso 12
Pág. 85

puntoffice 126 | 126 GLOBAL

Se aconseja el uso de grapas originales Maestri

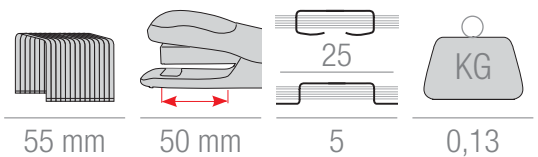

ELY 100

CÓDIGO	ARTÍCULO	PACK
0033113	ELY 100	12

Patas antideslizantes.



Indicador de carga de grapas.



Base giratoria que permite la grapa cerrada **A** grapa abierta **B**

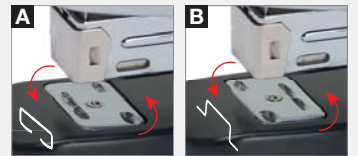

En la posición de grapa abierta **B** permite, si fuese necesario, retirar la grapa manualmente, evitando así el grapado permanente de los folios (máx. 5).

Disponible en:

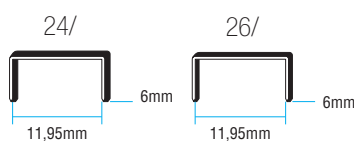

Para todas las grapas de paso 12
Pág. 85

puntoffice 126 | 126 GLOBAL

Se aconseja el uso de grapas originales Maestri



75 mm

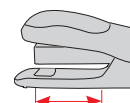

70 mm



5



0,15

ROMALANG 17

Grapadora profesional de brazo largo para grapas de profundidad y espesores altos. Fácil de cargar, máxima

estabilidad. Uso ágil y sin esfuerzo, grapado suave. Utilizada por encuadernadores, tipógrafos,

centros de impresión, bancos, despachos jurídicos, etc. Para grapar folletos, fascículos, etc.

Frontal abrible para extraer fácilmente la grapa.



Regulación de la profundidad de grapado.



Disponible en:



CÓDIGO	ARTÍCULO	PACK
0044103	ROMALANG 10/17	1
0044203	ROMALANG S17	1





**ROMALANG
Mod. 10/17**

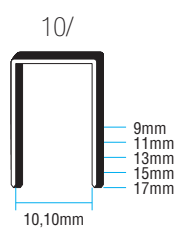

Pág. 86

**ROMALANG
Mod. S17**

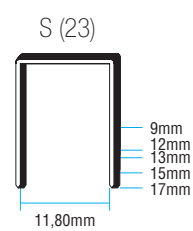

10/ S

Se aconseja el uso de grapas originales Maestri

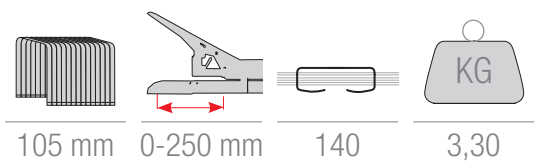

ROMABLOK 17

Grapadora profesional para altos espesores. Fácil de cargar, máxima estabilidad. Uso ágil y sin esfuerzo,

grapado suave. Utilizada por encuadernadores, tipógrafos, centros de

impresión, bancos, despachos jurídicos, etc. Para grapar folletos, fascículos, etc.

Frontal abrible para extraer fácilmente la grapa.



Regulación de la profundidad de grapado.



Disponible en:



CÓDIGO	ARTÍCULO	PACK
0043103	ROMABLOK 10/17	1
0043203	ROMABLOK S17	1





**ROMABLOK
Mod. 10/17**

10/

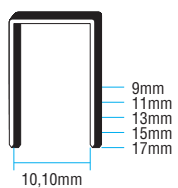

Pág. 86

**ROMABLOK
Mod. S17**

S (23)

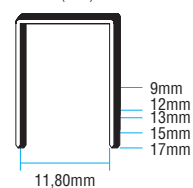

10/ S

Se aconseja el uso de grapas originales Maestri

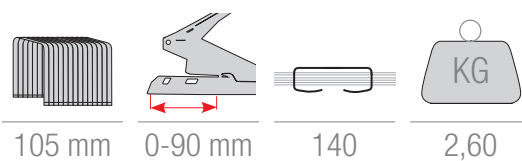

105 mm

0-90 mm

140

2,60

ROMABLOK 24

Grapadora profesional para altos espesores. Fácil de cargar, máxima estabilidad.

Uso ágil y sin esfuerzo, grapado suave. Utilizada por encuadernadores, tipógrafos,

centros de impresión, bancos, despachos jurídicos, etc. Para grapar folletos, fascículos, etc.

Frontal abrible para extraer fácilmente la grapa.



Regulación de la profundidad de grapado.



Disponible en:



Made in Italy

CÓDIGO	ARTÍCULO	PACK
0045105	ROMABLOK 10/24	1
0045205	ROMABLOK S24	1





**ROMABLOK
Mod. 10/24**

10/

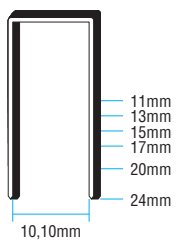

Pág. 86

**ROMABLOK
Mod. S24**

S (23)

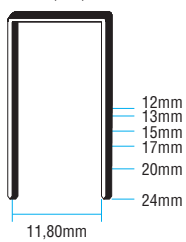

10/ S

Se aconseja el uso de grapas originales Maestri

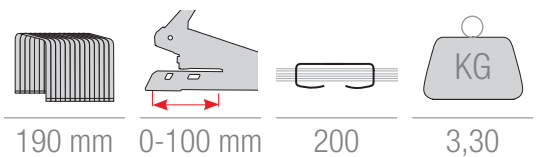

190 mm

0-100 mm

200

3,30

EUROBLOK 13

Grapadoras profesionales para altos espesores. Completamente de metal. Robustas y fiables.

Utilizadas por encuadernadores, tipógrafos o despachos legales. Carga posterior.

Base antideslizante.



Regulación de la profundidad de grapado.



Disponible en:



CÓDIGO	ARTÍCULO	PACK
0048104	EUROBLOK 13	1



S (23)

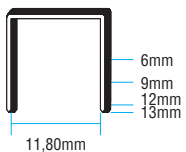

S

Se aconseja el uso de grapas originales Maestri

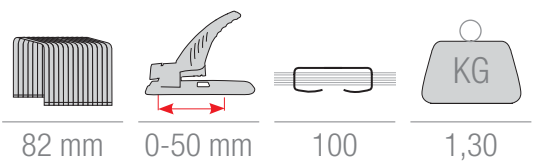

EUROBLOK 24

CÓDIGO	ARTÍCULO	PACK
0048106	EUROBLOK 24	1



Base antideslizante.



Regulación de la profundidad de grapado.



Base giratoria.



Disponible en:



S (23)

ROTACIÓN DE LA BASE

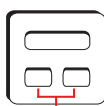
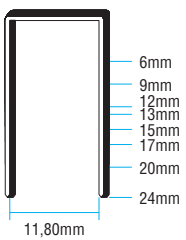

6mm
9mm
12mm
13mm
15mm



17mm
20mm
24mm

S



82 mm

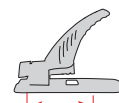

0-53 mm



200



1,70

QUITAGRAPAS

TOP - EUROREMOVER

Prácticos y modernos, con muelle de acero. Extracción fácil para todo tipo de grapas en la oficina sin estropear el papel. Para oficinas, bancos, organismos públicos, para casa, para la escuela y para manualidades.

Totalmente de metal.



Disponible en:



CÓDIGO	ARTÍCULO	PACK
0095001	TOP	25
0095037	EUROREMOVER	25
> 0095009	TOP	10
> blister		

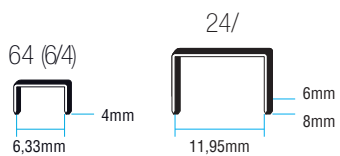

Para todas las grapas con un paso de 6 y 12
Pág. 85



Grapadoras de pinza para aplicaciones especiales, (p. ej. para el sector de la peletería).

ROMA FUR

CÓDIGO	ARTÍCULO	PACK
> 0090301	ROMA FUR	10
> aplicación para peleterías		

Disponible en:



24/

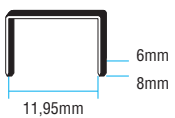

Pág. 85

puntoffr 126-128 | **126 GLOBAL**

Se aconseja el uso de grapas originales Maestri

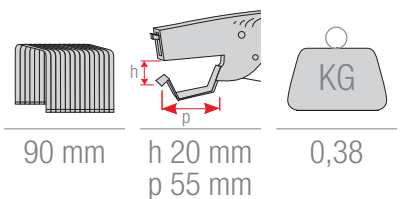

EUROPUNCH 21	46
EUROPUNCH 22	47
EUROPUNCH 23	48
EUROPUNCH 24	49
EUROPUNCH 25 2F	50
EUROPUNCH 25 4F	51
EUROPUNCH 4F	52
RO-MA JUMBO	53
ROMA CLIP	54
LABELS	56





EUROPUNCH 21

Taladradoras prácticas,
elegantes, robustas,
profesionales, disponibles
en diversas medidas.

Cuerpo de metal.
Perforan todo tipo de papel.
Para oficinas, escuelas,
bancos, manualidades.

Base de recogida de papel.



Escuadra de regulación.



Disponible en:



CÓDIGO	ARTÍCULO	PACK
0096012	EUROPUNCH 21	12



LIGHT DUTY

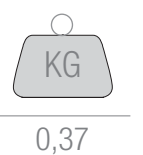
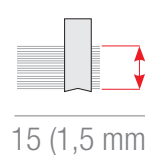
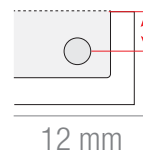
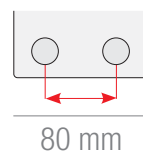

CÓDIGO	ARTÍCULO	PACK
0096115	EUROPUNCH 22	12

Base de recogida de papel.



Escuadra de regulación.



Disponible en:



LIGHT DUTY

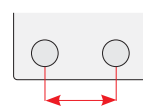

80 mm

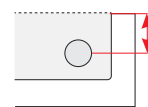

12 mm

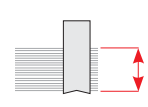

25 (2,5 mm)



0,45

EUROPUNCH 23

Taladradoras prácticas,
elegantes, robustas,
profesionales, disponibles
en diversas medidas.

Cuerpo de metal.
Perforan todo tipo de papel.
Para oficinas, escuelas,
bancos, manualidades.

Base de recogida de papel.



Escuadra de regulación.



Disponible en:



CÓDIGO	ARTÍCULO	PACK
0096119	EUROPUNCH 23	12



LIGHT DUTY

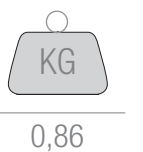
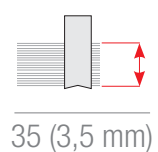
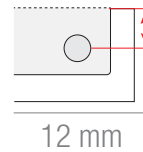
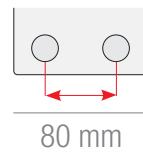

CÓDIGO	ARTÍCULO	PACK
0096117	EUROPUNCH 24	12

Base de recogida de papel.



Escuadra de regulación.



Disponible en:



HEAVY DUTY

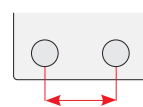

80 mm

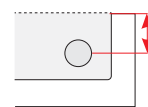

12 mm

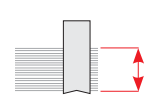

45 (4,5 mm)



0,94

EUROPUNCH 25 2F

*Taladradoras prácticas,
elegantes, robustas,
profesionales, disponibles
en diversas medidas.*

*Perforan todo tipo de papel.
Para oficinas, escuelas,
bancos, manualidades.*

Base de recogida de papel.



Escuadra de regulación.



Discos giratorios.



Disponible en:



CÓDIGO	ARTÍCULO	PACK
0096315	EUROPUNCH 25 2F	12

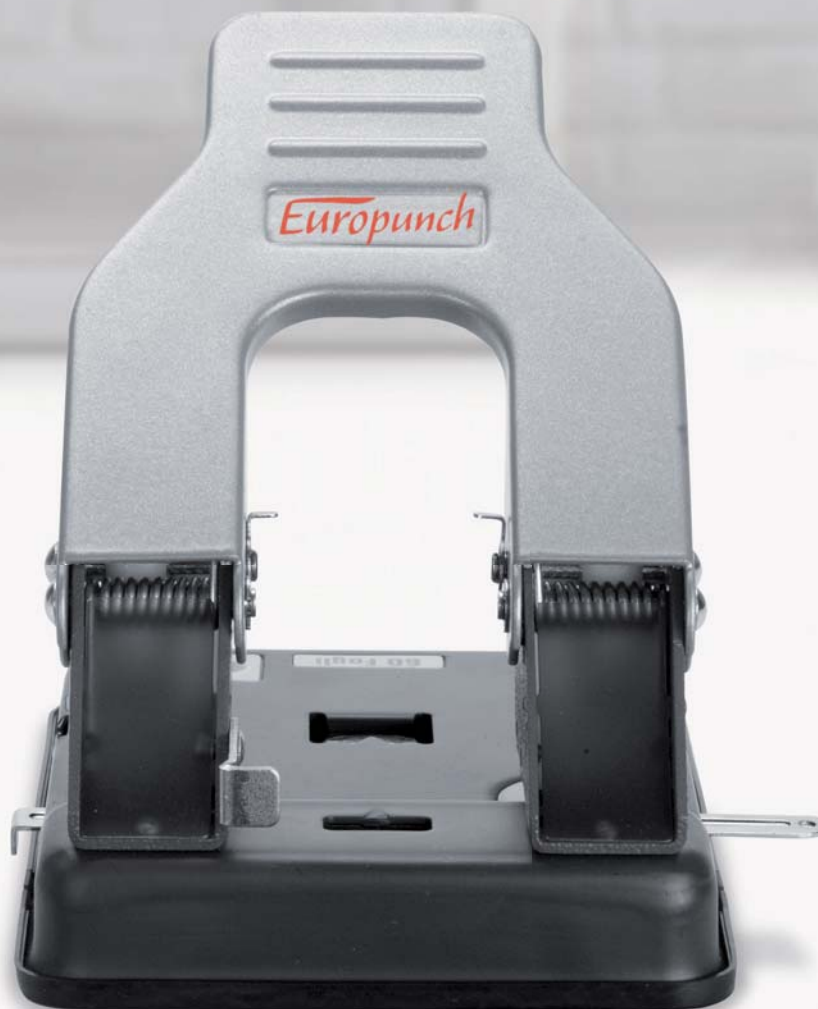

HEAVY DUTY

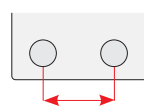

80 mm

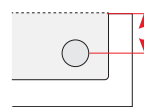

9 mm

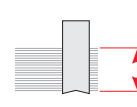

60 (6 mm)



1

EUROPUNCH 25 4F

CÓDIGO	ARTÍCULO	PACK
0096316	EUROPUNCH 25 4F	6

Base de recogida de papel.



Escuadra de regulación.



Disponible en:



HEAVY DUTY

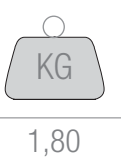
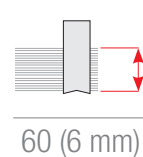
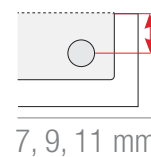
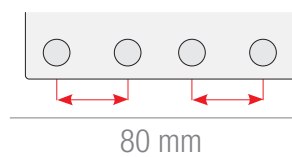

EUROPUNCH 4F

*Elegante, robusta,
profesional.
Perfora todo tipo de papel.
Cuerpo de metal.*

*Para oficinas, escuelas,
bancos, manualidades.*

Base de recogida de papel.



Disponible en:



CÓDIGO	ARTÍCULO	PACK
0096212	EUROPUNCH 4F	4



LIGHT DUTY

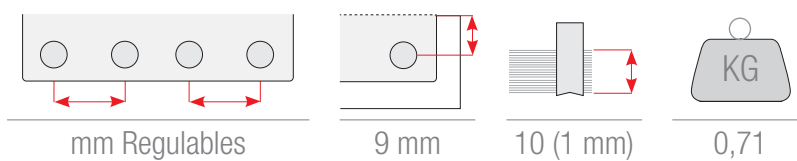

RO-MA JUMBO

Taladradora para altos espesores. *Cajón posterior de descarga de papel. Cuenta con 2 punzones de recambio y discos de plástico.*
 Muy robusta.
 Diámetro del orificio: 6 mm.

CÓDIGO	ARTÍCULO	PACK
0096401	RO-MA JUMBO	1

Escuadra de regulación de acero.

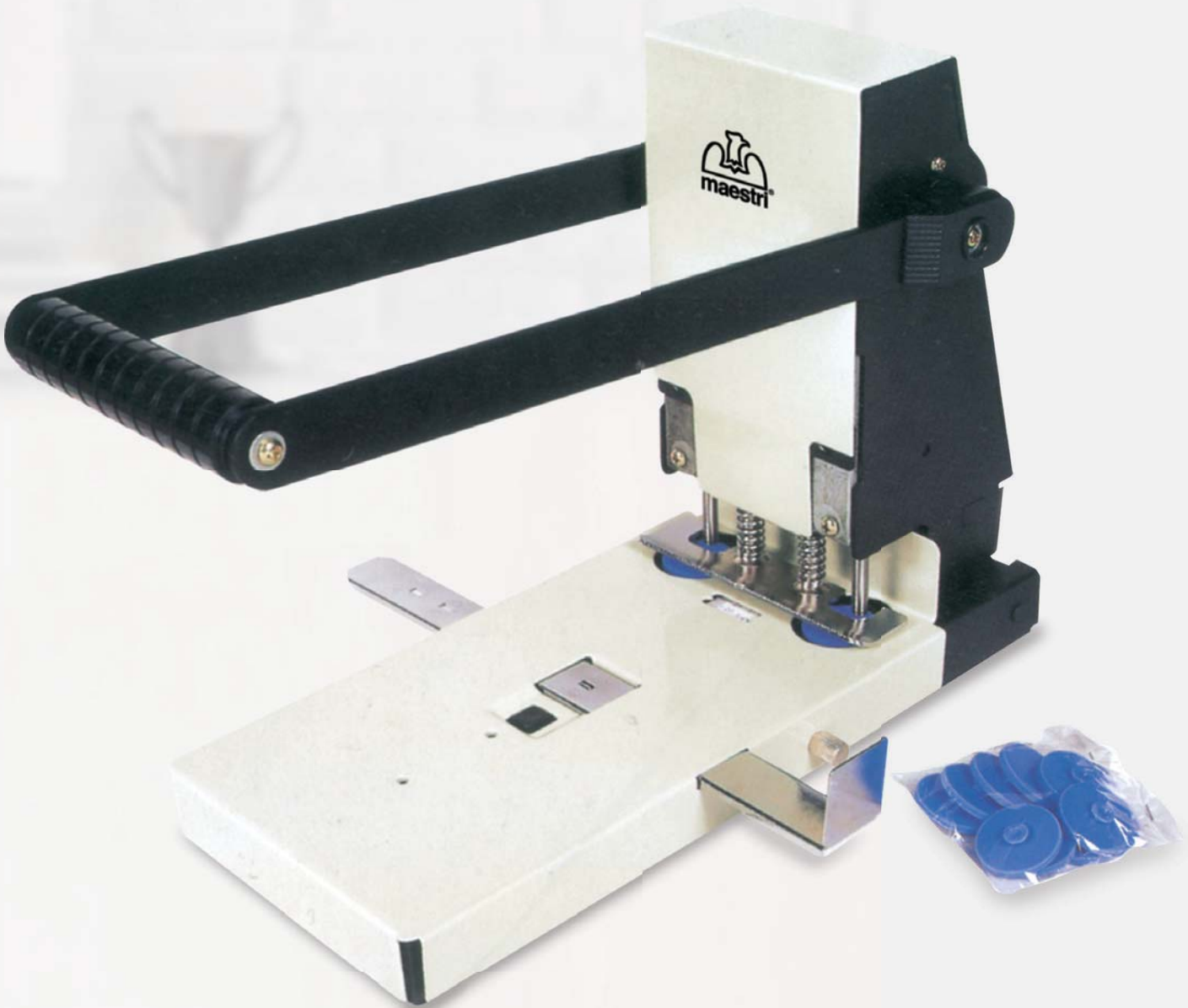

HEAVY DUTY

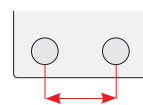

80 mm

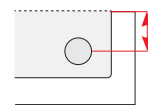

8-18 mm

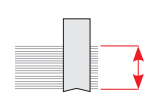

270-280
(28 mm)



5,70

CLIPS





Clips fabricados con alambre galvanizado de alta resistencia, cuyas características

dimensionales, junto con la excelente calidad de la materia prima, constituyen la garantía

cualitativa para una óptima sujeción de los folios.

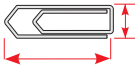
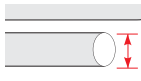
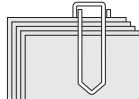
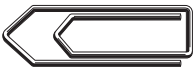
CÓDIGO	ARTÍCULO	PACK
1092102	ROMA CLIP N°2 GALVANIZADAS - 100/1.000	250 (25.000 clips)
1092103	ROMA CLIP N°3 GALVANIZADAS - 100/1.000	250 (25.000 clips)
1092104	ROMA CLIP N°4 GALVANIZADAS - 100/1.000	200 (20.000 clips)
1092105	ROMA CLIP N°5 GALVANIZADAS - 100/1.000	100 (10.000 clips)
1092106	ROMA CLIP N°6 GALVANIZADAS - 100/1.000	100 (10.000 clips)



				
		dimensiones	diámetro alambre	Sujeción folios máx.
Modelo ROMA CLIP 2		8x25 mm	Ø 0,8 mm	10
Modelo ROMA CLIP 3		9x29 mm	Ø 0,9 mm	15
Modelo ROMA CLIP 4		10x33 mm	Ø 1 mm	20
Modelo ROMA CLIP 5		10,5x49 mm	Ø 1 mm	25
Modelo ROMA CLIP 6		11x57 mm	Ø 1,25 mm	30

Colores disponibles:



Disponible en:

Caja de 100
Hojas en formato A4



ETIQUETAS AUTOADHESIVAS PARA IMPRESORAS

Etiquetas aptas para todas las impresoras láser, de chorro de tinta y fotocopiadoras.

Disponibles bajo solicitud con adhesivo extraíble, en diferentes formatos.

Estudiadas especialmente para eliminar toda posibilidad de atasco, alta calidad de impresión

Nº ETIQUETAS/HOJA	CÓDIGO	ARTÍCULO	PACK	Nº ETIQUETAS/HOJA	CÓDIGO	ARTÍCULO	PACK
	1095200	210x297 mm BLANCO	10		1095212	105x48 mm BLANCO	10
	1095201	210x297 mm AMARILLO FLÚOR	10				
	1095269	210x297 mm VERDE FLÚOR	10				
	1095270	210x297 mm NARANJA FLÚOR	10				
	1095205	205x297 mm BLANCO	10				
	1095202	210x148 mm BLANCO	10		1095266	105x42,4 mm BLANCO	10
	1095203	210x148 mm AMARILLO FLÚOR	10				
	1095286	210x148 mm NARANJA FLÚOR	10		1095213	105x40 mm BLANCO	10
	1095203A	210x148 mm VERDE FLÚOR	10				
	> 1095206	200x144 mm BLANCO	10		1095214	105x37 mm BLANCO	10
	1095204	210x148 mm BLANCO	10				
	1095204	210x40 mm BLANCO	10		1095215	105x36 mm BLANCO	10
	> 1095272	185x112 mm BLANCO	10				
	> 1095267	199,6x289,1 mm BLANCO	10		1095217	105x24 mm BLANCO	10
	> 1095271	196x289 mm BLANCO	10				
	> 1095207	190x61 mm BLANCO	10		1095218	101x72 mm BLANCO	10
	1095208	105x148 mm BLANCO	10				
	1095208D	105x148 mm ROJO FLÚOR	10		1095219	101x36 mm BLANCO	10
	1095208E	105x148 mm AMARILLO FLÚOR	10				
	1095209	105x74 mm BLANCO	10				
	1095209D	105x74 mm VERDE FLÚOR	10		> 1095220	99,1x93,1 mm BLANCO	10
	1095210	105x72 mm BLANCO	10				
	1095211	105x57 mm BLANCO	10				
	> 1095223	99,1x144 mm BLANCO	10		> 1095221	99,1x67,7 mm BLANCO	10
	> 1095223D	99,1x144 mm VERDE FLÚOR	10				
	> 1095223E	99,1x144 mm ROJO FLÚOR	10				
	> 1095223F	99,1x144 mm AMARILLO FLÚOR	10				
	> 1095224	99,1x34 mm BLANCO	10		> 1095222	99,1x38,1 mm BLANCO	10
	1095226	99x34 mm BLANCO	10				
	> 1095225	99x57 mm BLANCO	10				

gracias al elevado
punto objetivo. Usos
múltiples: para direcciones,
campañas de buzoneo,

envíos, etiquetado de
embalajes y paquetes, etc.

Nº ETIQUETAS/HOJA	CÓDIGO	ARTÍCULO	PACK	Nº ETIQUETAS/HOJA	CÓDIGO	ARTÍCULO	PACK	Nº ETIQUETAS/HOJA	CÓDIGO	ARTÍCULO	PACK
	> 1095273	98x25,4 mm BLANCO	10		1095243	68,5x23 mm BLANCO	10		> 1095276	47x35 mm BLANCO	10
	1095227	97x67,7 mm BLANCO	10		1095244	67x36 mm BLANCO	10		> 1095256	47,8x25,5 mm BLANCO	10
	1095228	97x42,4 mm BLANCO	10		1095245	64,6x33,8 mm BLANCO	10		1095257	45,2x54,8 mm BLANCO	10
	1095229	70x67,7 mm BLANCO	10		> 1095246	64x34 mm BLANCO	10		1095277	42x25 mm BLANCO	10
	1095230	70x50,8 mm BLANCO	10		> 1095247	63,5x72 mm BLANCO	10		1095258	40x40 mm BLANCO	10
	1095231	70x48 mm BLANCO	10		> 1095248	63,5x46,6 mm BLANCO	10		1095259	38x21,2 mm BLANCO	10
	1095232	70x48 mm NARANJA FLÚOR	10		> 1095249	63,5x38,1 mm BLANCO	10		> 1095260	38,1x21,2 mm BLANCO	10
	1095233	70x42,4 mm BLANCO	10		1095250	50x36 mm BLANCO	10		> 1095262	37,5x23,5 mm BLANCO	10
	1095234	70x37 mm BLANCO	10		1095251	52,5x29,7 mm BLANCO	10		> 1095278	30x30 mm BLANCO	10
	1095235	70x36 mm BLANCO	10		1095252	52,5x21,21 mm BLANCO	10		1095263	25x15 mm BLANCO	10
	1095236	70x36 mm NARANJA FLÚOR	10		1095253	51x48 mm BLANCO	10		> 1095279	25x10 mm BLANCO	10
	1095237	70x36 mm VERDE FLÚOR	10		1095274	52,5x25,4 mm BLANCO	10		1095264	ø60 mm ROUND BLANCO	10
	1095238	70x35 mm BLANCO	10		1095254	48,5x25,4 mm BLANCO	10		1095265	ø114-ø40 mm ROUND CD BLANCO	10
	1095239	70x32 mm BLANCO	10		1095275	48x24,75 mm BLANCO	10				
	1095240	70x30 mm BLANCO	10		1095255	48,5x16,9 mm BLANCO	10				
	1095242	70x10 mm BLANCO	10								

> esquinas redondeadas



SWING M	60
OPEN	62
LABEL-ROLL	64
INK-ROLL	65







ETIQUETADORAS DE PRECIOS

Etiquetadoras de precios para etiquetas en rollo. Diversos modelos disponibles. Cuerpo

de plástico. Manilla ergonómica. Puerta abatible para facilitar la carga en rollo de las etiquetas.

CÓDIGO	ARTÍCULO	PACK
0097226	SWING M 1626	1
0097227	SWING M 1426	1
0097232	SWING M 621	1
0097231	SWING M 622	1
0097233	SWING M 821	1
0097234	SWING M 626	1
0097235	SWING M 826	1
0097251	SWING M826 CON ACCESORIOS/750	1
0097252	SWING M 821 CON ACCESORIOS/1500	1



Modelo SWING M 1626 Etiquetadora de precios con 2 líneas de impresión	 26x16 mm	8+8 caracteres		
Modelo SWING M 1426 Etiquetadora de precios con 1 línea de impresión	 26x16 mm	8+6 caracteres		
Modelo SWING M 621 Etiquetadora de precios con 1 línea de impresión	 21x12 mm	6 caracteres		
Modelo SWING M 622 Etiquetadora de precios con 1 línea de impresión	 22x12 mm	6/8 caracteres		
Modelo SWING M 821 Etiquetadora de precios con 1 línea de impresión	 21x12 mm	8 caracteres		
Modelo SWING M 626 Etiquetadora de precios con 1 línea de impresión	 26x12 mm	6 caracteres		
Modelo SWING M 826 Etiquetadora de precios con 1 línea de impresión	 26x12 mm	8 caracteres		
SWING M826 CON ACCESORIOS/750 1 etiquetadora de precios + 1 rollo de tinta + 10 etiquetas de 750 pc	 26x12 mm	8 caracteres		
SWING M821 CON ACCESORIOS/1500 1 etiquetadora de precios + 1 rollo de tinta + 4 etiquetas de 1.500 pc	 21x12 mm	8 caracteres		



ETIQUETAS
RECTANGULARES



ETIQUETAS
CON ONDA

ETIQUETADORAS DE PRECIOS

Etiquetadoras de precios para etiquetas en rollo. *Manilla ergonómica.*
 Diversos modelos disponibles. *Puerta abatible para facilitar la carga en rollo de las etiquetas.*
 Cuerpo de plástico. *etiquetas.*



CÓDIGO	ARTÍCULO	PACK
0097225	OPEN S14	1
0097236	OPEN M 6	1
0097237	OPEN TEX	1
0097238	OPEN C20 A	1
0097239	OPEN C8	1





Modelo OPEN S14 Etiquetadora de precios con 1 línea de impresión	 26x16 mm	8+8 caracteres	 R	 W
Modelo OPEN M6 Etiquetadora de precios con 1 línea de impresión	 26x16 mm	6 caracteres	 R	 W
Modelo OPEN TEX Numerador mod. 2644 Etiquetadora de precios con 1 línea de impresión	 26x16 mm	4 caracteres fijos 4 caracteres consecutivos		 W
Modelo OPEN C20 A Etiquetadora de precios alfanumérica con 2 líneas de impresión	 26x16 mm	10+10 caracteres	 R	
Modelo OPEN C8 Etiquetadora de precios con 1 línea de impresión	 26x12 mm	8 caracteres	 R	 W



ETIQUETAS
RECTANGULARES

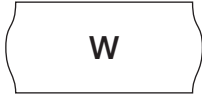

























































































ETIQUETAS
CON ONDA



ETIQUETAS PARA ETIQUETADORAS DE PRECIOS

Etiquetas autoadhesivas permanentes, extraíbles disponibles en varios y específicos para colores, formato rectangular congelados. y de onda, con adhesivos

ETIQUETAS	CÓDIGO	ARTÍCULO		PACK
W	 1095120	26X16w Euro AZUL/AMARILLA	36  /1.000	1
W	 1095301AZ	26X12w Permanente AZUL	36  /1.500	1
R	 1095376AR	21X12r Permanente NARANJA FLÚOR	50  /1.000	1
	 1095376GI	21X12r Permanente AMARILLO FLÚOR	50  /1.000	1
	 1095376MA	21X12r Permanente MAGENTA FLÚOR	50  /1.000	1
	 1095376RO	21X12r Permanente ROJO FLÚOR	50  /1.000	1
	 1095376VE	21X12r Permanente VERDE FLÚOR	50  /1.000	1
	W	 1095377AR	26X12w Permanente NARANJA FLÚOR	36  /1.500
 1095377GI		26X12w Permanente AMARILLO FLÚOR	36  /1.500	1
 1095377MA		26X12w Permanente MAGENTA FLÚOR	36  /1.500	1
 1095377RO		26X12w Permanente ROJO FLÚOR	36  /1.500	1
 1095377VE		26X12w Permanente VERDE FLÚOR	36  /1.500	1
W		 1095378AR	26X16w Permanente NARANJA FLÚOR	36  /1.000
	 1095378GI	26X16w Permanente AMARILLO FLÚOR	36  /1.000	1
	 1095378MA	26X16w Permanente MAGENTA FLÚOR	36  /1.000	1
	 1095378RO	26X16w Permanente ROJO FLÚOR	36  /1.000	1
	 1095378VE	26X16w Permanente VERDE FLÚOR	36  /1.000	1
	R	 1095379AR	26X16r Permanente NARANJA FLÚOR	36  /1.000
 1095379GI		26X16r Permanente AMARILLO FLÚOR	36  /1.000	1
 1095379MA		26X16r Permanente MAGENTA FLÚOR	36  /1.000	1
 1095379RO		26X16r Permanente ROJO FLÚOR	36  /1.000	1
 1095379VE		26X16r Permanente VERDE FLÚOR	36  /1.000	1
W		 1095380AR	32X19w Permanente NARANJA FLÚOR	30  /1.000
	 1095380GI	32X19w Permanente AMARILLO FLÚOR	30  /1.000	1
	 1095380MA	32X19w Permanente MAGENTA FLÚOR	30  /1.000	1
	 1095380RO	32X19w Permanente ROJO FLÚOR	30  /1.000	1
	 1095380VE	32X19w Permanente VERDE FLÚOR	30  /1.000	1
	R	 1095300	21X12r Permanente BLANCO	50  /1.000
W	 1095301	26X12w Permanente BLANCO	36  /1.500	1
	 1095301GI	26X12w Permanente AMARILLO	36  /1.500	1
W	 1095302	26X16w Permanente BLANCO	36  /1.000	1
	 1095302GI	26X16w Permanente AMARILLO	36  /1.000	1
R	 1095303	26X16r Permanente BLANCO	36  /1.000	1
W	 1095304	32X19w Permanente BLANCO	30  /1.000	1
R	 1095326	21X12r Extraíble BLANCO	50  /1.000	1
W	 1095327	26X12w Extraíble BLANCO	36  /1.500	1
W	 1095328	26X16w Extraíble BLANCO	36  /1.000	1
R	 1095329	26X16r Extraíble BLANCO	36  /1.000	1
W	 1095330	32X19w Extraíble BLANCO	30  /1.000	1
R	 1095351	21X12r para Congelados BLANCO	50  /1.000	1
W	 1095352	26X12w para Congelados BLANCO	36  /1.500	1
W	 1095353	26X16w para Congelados BLANCO	36  /1.000	1
R	 1095354	26X16r para Congelados BLANCO	36  /1.000	1
W	 1095355	32X19w para Congelados BLANCO	30  /1.000	1

Tampones de rodillo con soporte de plástico, espuma con tinta no tóxica y base acuosa sin alcohol.

CÓDIGO	ARTÍCULO	PACK
1095115	INK ROLL mod. Open	250
1095116	INK ROLL mod. Blitz	250
1095117	INK ROLL mod. Tovel	250
1095118	INK ROLL mod. Jolly	250
1095119	INK ROLL mod. Swing	250
1095121	INK ROLL mod. Open M6	250
1095122	INK ROLL mod. Open Tex	250
1095123	INK ROLL Numerador mod. Open Tex	250

Amplia gama de tampones entintados de rodillo

para etiquetadoras de precios modelo **SWING**, **OPEN**



Modelo SWING pág. 60 ▲



Modelo OPEN pág. 62 ▲



LD1	68
SECUR VVB	69
EURO BJ212	70
EURO 701B	71
AL130	72
DORS230	73
BJ05	74
EUROBANK LD60	75
EURO BJ20	76
DP-7011-SE/3D	77
AL5000A	78
BJ6230	79
DP7100 E/3D	80
EURO 270	81
EURO 500	82
EURO 650 8/C	83
CS900S	84





Comprobador de billetes dotado de luz de Wood de alta luminosidad, doble sensor magnético

para la comprobación de la presencia del hilo magnético, doble LED blanco para la

comprobación de la presencia de la filigrana y de la microescritura. Dimensiones compactas.

Métodos de comprobación de billetes falsos:

- UV** ▶ Ultravioleta
- WM** ▶ Luz blanca para el control de filigrana
- MG** ▶ Detección de presencia de tinta magnética

CÓDIGO	ARTÍCULO	PACK
0097140	LD1	1



- Consumo luz UV 9 vatios
- Luz blanca con 2 LED de bajo consumo
- Sensor MG 2 sensores

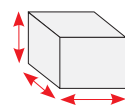

13x10x18 cm

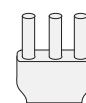

AC220V
50-60 Hz



0,10

Comprobador de billetes con telecámara infrarroja para detectar la presencia de tintas de

seguridad especiales. El resultado se visualiza en un monitor CRT de 4" B/N.

Circuito para el ahorro energético y salvapantallas con encendido y apagado automáticos.

SECUR VVB

CÓDIGO	ARTÍCULO	PACK
0097113	SECUR VVB	1

Métodos de comprobación de billetes falsos:

UV ▶ Ultravioleta

IR ▶ Infrarrojo



- Alimentación a la red de 12 V con alimentador por separado (incluido)
- LED UV para el control de los hologramas presentes en las principales tarjetas de crédito
- Monitor de 800x600 píxeles de resolución

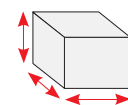

14x14x23 cm

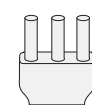

AC 220V
50 Hz/12 V



1,50

Comprobador para todos los billetes de Euros. Función de valoración del total comprobado. Inserción de

los billetes en cualquier dirección. Posibilidad de salida de los billetes por la parte delantera o trasera.

Dimensiones reducidas, fácil de utilizar, con baterías recargables para uso también sin corriente eléctrica.

Métodos de comprobación de billetes falsos:

- UV** ▶ Ultravioleta
- MG** ▶ Detección de presencia de tinta magnética
- 2D** ▶ Detección de los billetes de medio espesor y dimensión
- IR** ▶ Infrarrojo
- MT** ▶ Detección de presencia del hilo de seguridad
- IMAGE** ▶ Comprobación de imagen
- COLOR** ▶ Comprobación del color

SOFTWARE ACTUALIZABLE

CÓDIGO	ARTÍCULO	PACK
0097117	EURO BJ212	1



- Pantalla alfanumérica retroiluminada
- Señal acústica en caso de billete sospechoso
- 3 horas de autonomía de la batería en uso continuado
- Velocidad de recuento 0,5 s por billete

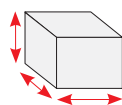

12,5x8,8x5,9 cm



7,2V Ni-Mh
RECARGABLES

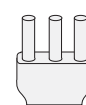

AC240V
50-60 Hz

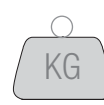

0,30
batería
no incluida

Comprobador de billetes semiautomático que permite comprobar de forma rápida y segura la autenticidad de los billetes. Comprueba el valor y el número de billetes sobre la pantalla, ya sea en función de su valor nominal o del adicional.

EURO 701B

CÓDIGO	ARTÍCULO	PACK
0097141	EURO 701B	1

Métodos de comprobación de billetes falsos:

- UV** ▶ Ultravioleta
- MG** ▶ Detección de presencia de tinta magnética
- 2D** ▶ Detección de los billetes de medio espesor y dimensión
- IR** ▶ Infrarrojo
- MT** ▶ Detección de presencia del hilo de seguridad

SOFTWARE ACTUALIZABLE



- Pantalla alfanumérica retroiluminada
- Control de las dimensiones de los billetes
- 3 horas de autonomía de la batería en uso continuado
- Velocidad de recuento 0,5 s por billete

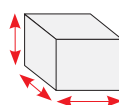

12,4x10x6,9 cm

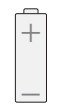

7,4V 650mAH
RECARGABLES

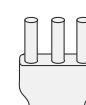

AC240V
50-60 Hz

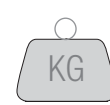

0,34

COMPROBADORES DE BILLETES

Comprobador para todos los billetes de Euro. Funciona mediante la lectura magnética de la presencia del hilo de seguridad, de la tinta magnética, de las dimensiones, del color,

lectura infrarroja y ultravioleta. Función de contabilización del total comprobado o dividido por denominación. Inserción de los billetes en cualquier dirección. Posibilidad de salida de los

billetes por la parte delantera o trasera. Dimensiones reducidas, fácil de utilizar en caja, con baterías recargables para uso también sin corriente eléctrica (función opcional).

Métodos de comprobación de billetes falsos:

- IR** ▶ Infrarrojo
- MG** ▶ Detección de presencia de tinta magnética
- MT** ▶ Detección de presencia del hilo de seguridad
- 2D** ▶ Detección de los billetes de medio espesor y dimensión
- IMAGE** ▶ Comprobación de imagen
- COLOR** ▶ Comprobación del color

SOFTWARE ACTUALIZABLE

CÓDIGO	ARTÍCULO	PACK
0097142	AL130	1



- Pantalla alfanumérica retroiluminada
- Velocidad de recuento <0,5 segundos por billete

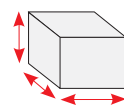

15,5x13,7x8,2 cm

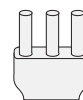

AC 100-240V
50/60Hz



0,45
batería
no incluida

DORS230

Comprobador multidivisa sencillo y de dimensiones reducidas. Comprueba los billetes mediante el reconocimiento automático, visualizando en pantalla el corte y la divisa del billete. Todas las monedas del mundo

en un solo modelo. Presenta el innovador sistema de validación de billetes patentado que emplea un sensor de imagen (CIS). Comprueba el billete y garantiza una extraordinaria fiabilidad. Si el billete es sospechoso,

lo rechaza y emite una señal acústica, para mostrar en pantalla el tipo de error. Elevando la cubierta se puede limpiar muy fácilmente el sensor y los rodillos de arrastre del billete.

CÓDIGO	ARTÍCULO	PACK
0097143	DORS230	1

Métodos de comprobación de billetes falsos:

IR ▶ Infrarrojo

UV ▶ Ultravioleta

DD ▶ Altura billete

TRANSPARENCIA ▶
Control de la transparencia

SOFTWARE ACTUALIZABLE



- La pantalla visualiza el número de billetes contados, valor individual y total
- Pantalla táctil en color de 3,5"
- Configuración de salida posterior o frontal para los billetes correctos o sospechosos
- Velocidad de recuento <0,5 segundos por billete

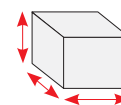

11,5x10,45x8,6 cm

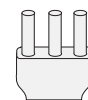

AC 220-240V
50/60Hz



0,550

CONTADORES DE BILLETES

Cuenta y comprueba billetes con carga posterior. Dotado de un doble sistema de comprobación UV, MG, con posibilidad de excluso para

el uso en recuento libre (p. ej. automático, uso intuitivo y de Vales de comida). Ligero y de dimensiones compactas, es ideal para quienes dispongan de poco espacio. Arranque

Métodos de comprobación de billetes falsos:

UV ▶ Ultravioleta

MG ▶ Detección de presencia de tinta magnética

CÓDIGO	ARTÍCULO	PACK
0097112	BJ05	1



- Pantalla LCD de 6 cifras
- Velocidad de recuento 850 billetes por minuto
- Cant. máx. billetes en carga: aprox. 200
- Cant. máx. billetes en recogida: aprox. 130

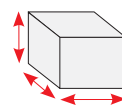

28x22,5x14 cm

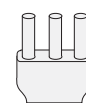

AC230V
50 Hz



4,50

EUROBANK LD60

Contador de billetes versátil,
estudiado expresamente
para todas las aplicaciones.

Ideal para el recuento de
grandes lotes de billetes.

CÓDIGO	ARTÍCULO	PACK
0097123	EUROBANK LD60	1

Métodos de comprobación
de billetes falsos:

DD ▶ Altura billete

TRANSPARENCIA ▶
Control de la
transparencia

SOFTWARE ACTUALIZABLE



- Velocidad de recuento 600/1.200/1.500 billetes por minuto
- Cant. máx. billetes en carga: aprox. 300
- Cant. máx. billetes en recogida: aprox. 200

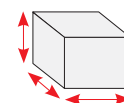

27,2x23,5x23,9 cm

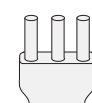

AC230V
50 Hz



7

EURO BJ20

Se trata de un contador de billetes profesional, inteligente para el recuento de grandes

lotes de billetes. Con teclado de membrana y dos pantallas de 3 y 4 cifras con sistema de guardado del último modo de uso.

Métodos de comprobación de billetes falsos:

- UV** ▶ Ultravioleta
- MG** ▶ Detección de presencia de tinta magnética
- MT** ▶ Detección de presencia del hilo de seguridad
- DD** ▶ Altura billete

CÓDIGO	ARTÍCULO	PACK
0097124	EURO BJ20	1



- Cant. máx. billetes en carga: aprox. 300
- Cant. máx. billetes en recogida: aprox. 200

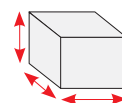

27,2x23,5x23,9 cm



AC230V
50 Hz



7

Contador de billetes Paso de hojas óptimo incluso
inteligente para el recuento para billetes desgastados y
de grandes lotes de billetes. de corte pequeño.

CÓDIGO	ARTÍCULO	PACK
0097134	DP-7011-SE/3D	1



Métodos de comprobación de billetes falsos:

- UV** ▶ Ultravioleta
- MG** ▶ Detección de presencia de tinta magnética
- MT** ▶ Detección de presencia del hilo de seguridad
- DOBLE IR** ▶ Infrarrojo
- COLOR** ▶ Comprobación del color
- 3D** ▶ Control 3D

SOFTWARE ACTUALIZABLE

Conforme a las directivas:

- ▶ ROHS
- ▶ 2006/42/CE



- Velocidad de recuento 800/1.200/1.500 billetes por minuto
- Cant. máx. billetes en carga: aprox. 300
- Cant. máx. billetes en recogida: aprox. 250

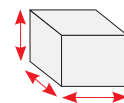

23,5x29x19,5 cm

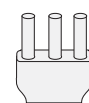

AC230V
50 Hz



6,40

VALORADORAS DE BILLETES

Valoradora de carga posterior.

Cuenta, comprueba y valora el total de los billetes

insertados. Cuenta con un panel de mandos.

Los mandos y las funciones se configuran con un solo

toque, mientras que la pantalla lateral permite leer todos los importes o piezas contadas.

Métodos de comprobación de billetes falsos:

MG ▶ Detección de presencia de tinta magnética

UV ▶ Ultravioleta

SOFTWARE ACTUALIZABLE

Conforme a las directivas:

▶ ROHS

▶ 2006/42/CE



CÓDIGO	ARTÍCULO	PACK
0097135	AL5000A	1



- Pantalla de LED
- Velocidad de recuento 1.000 billetes por minuto
- Cant. máx. billetes en carga: aprox. 200
- Cant. máx. billetes en recogida: aprox. 200

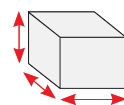

29,2x23,8x17,5 cm

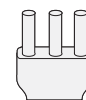

AC 230V
50Hz

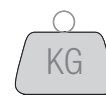

KG

5,8

BJ6230

Cuenta, comprueba y valora los billetes mixtos mediante un triple sensor compuesto por MT con control y

descodificación del código de seguridad para la detección de los billetes falsos, UV y MG para

posterior confirmación e IR para control dimensional.

CÓDIGO	ARTÍCULO	PACK
0097132	BJ6230	1



Métodos de comprobación de billetes falsos:

- UV** ▶ Ultravioleta
- MG** ▶ Detección de presencia de tinta magnética
- MT** ▶ Detección de presencia del hilo de seguridad
- 3D** ▶ Control 3D
- CIS** ▶ Color Image Sensor
- IR** ▶ Infrarrojo

SOFTWARE ACTUALIZABLE

- Pantalla LCD de 3 cifras
- Velocidad de recuento 1.800 billetes por minuto, cómodo de comprobación de billetes falsos de hasta 1.000
- Cant. máx. billetes en carga: aprox. 500
- Cant. máx. billetes en recogida: aprox. 200

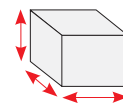

28,7x27,9x25,3 cm

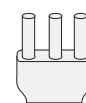

AC230V
50 Hz



8,50



DP7100 E/3D

VALORADORAS DE BILLETES

Cuenta, comprueba y valora el total de los billetes insertados en la carga frontal.

Está dotada de un panel de mandos con pantalla táctil, mientras que la pantalla lateral permite la lectura de todos los importes o piezas contadas.

Métodos de comprobación de billetes falsos:

- UV** ▶ Ultravioleta
- MG** ▶ Detección de presencia de tinta magnética
- MT** ▶ Detección de presencia del hilo de seguridad
- IR** ▶ Infrarrojo

SOFTWARE ACTUALIZABLE

Conforme a las directivas:

- ▶ ROHS
- ▶ 2006/42/CE



CÓDIGO	ARTÍCULO	PACK
0097133	DP7100-E/3D	1



- Velocidad de recuento 1.500 billetes por minuto, cómodo de comprobación de billetes falsos de hasta 1.200
- Cant. máx. billetes en carga: aprox. 300
- Cant. máx. billetes en recogida: aprox. 250

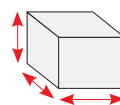

23,5x29x19,5 cm

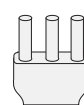

AC230V
50 Hz



6,70

CONTADORES SEPARADORES DE MONEDAS



Contador separador de monedas fiable y rápido, con diseño compacto y moderno.

Las monedas insertadas en la máquina se cuentan y se dividen en los distintos cajones.

Al finalizar el recuento, se puede obtener el informe de cada corte y el valor total de las monedas.

EURO 270

CÓDIGO	ARTÍCULO	PACK
0097150	EURO 270	1



- Pantalla LCD de 7 caracteres
- Velocidad de recuento 250 monedas por minuto
- Cant. máx. monedas en carga: hasta 500 aprox.
- Cant. máx. monedas en recogida: hasta 150 aprox.

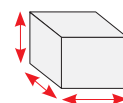

34,5x30,6x26 cm

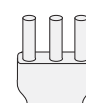

AC220/240V
50-60 Hz



4
KG

Seleccionadora de monedas compacta y de uso sencillo, con cuatro cajones y concebida especialmente

para las monedas de Euro. Selecciona, cuenta y preselecciona en lotes predefinidos.

Visualización del valor y de los números de piezas contadas para cada corte, todo en una sola operación.

CÓDIGO	ARTÍCULO	PACK
0097151	EURO 500	1



- Pantalla LCD de 7 caracteres
- Velocidad de recuento 250 monedas por minuto
- Cant. máx. monedas en carga: hasta 500 aprox.
- Cant. máx. monedas en recogida: hasta 250 aprox.

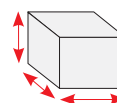

34,5x30,6x26 cm

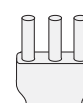

AC220/240V
50-60 Hz



4

Seleccionadora de monedas compacta y de uso sencillo, con ocho cajones y concebida especialmente

para las monedas de Euro. Selecciona, cuenta y preselecciona en lotes predefinidos. Visualización de

los valores y de los números de piezas contadas para cada corte, todo en una sola operación.

EURO 650 8/C

CÓDIGO	ARTÍCULO	PACK
0097152	EURO 650 8/C	1



- Pantalla LCD de 7 caracteres
- Velocidad de recuento 650 monedas por minuto
- Cant. máx. monedas en carga: hasta 500 aprox.
- Cant. máx. monedas en recogida: hasta 400 aprox.

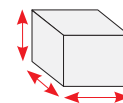

30,2x27,8x25,8 cm

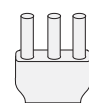

AC220V
50 Hz



5

Altamente profesional, con pantalla LCD. Producto ideal para la gestión completa del recuento y de la división

de las monedas, hasta 8 denominaciones. Función de recuento en lotes, piezas individuales, memoria y

valoración de las monedas. Ideal para todos los operadores que mueven grandes cantidades de monedas.

CÓDIGO	ARTÍCULO	PACK
0097153	CS900S	1



- Velocidad de recuento > 600 monedas por minuto
- Cant. máx. monedas en carga: hasta 3.600 aprox.
- Dotada de cajón de descarte de monedas no reconocidas

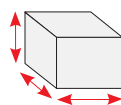

75x35x50 cm

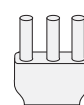

AC220V
50 Hz



KG

35

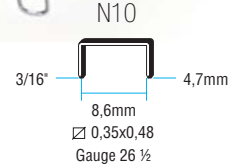
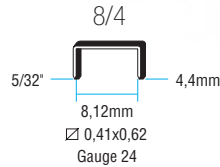
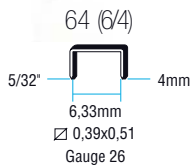

CÓDIGO	ARTÍCULO	PACK
1001121	JOLLY ORO - 1.000/10.000	500.000
1001131	JOLLY ORO - 2.000/10.000	500.000
1001101	64 ORO - 2.000/20.000	500.000
1001310	64 GLOBAL - 1.000/10.000	500.000
1001403	64 LUCIDI - 2.000/20.000	500.000
> 1010025	JOLLY ORO - 4 x 1.000	20

> blister

PÁG							
4	5	10	14	16	17	18	21
42							

CÓDIGO	ARTÍCULO	PACK
1002301	8/4 - 1.000/10.000	500.000

PÁG			
6	11	15	19

CÓDIGO	ARTÍCULO	PACK
1002101	N 10 - 1.000/10.000	250.000

PÁG					
7	12	15	23	25	27

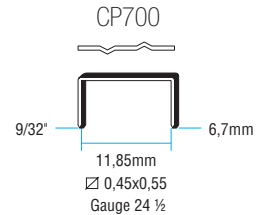
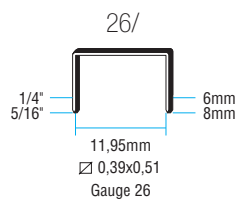
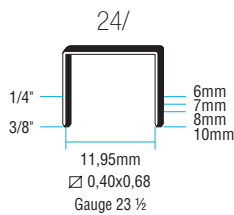

CÓDIGO	ARTÍCULO	PACK
1003103	126 ORO - 1.000/10.000	250.000
1003105	126 GLOBAL - 1.000/10.000	250.000
1003404	127 LUCIDI - 10.000	250.000
1003601	128 ORO - 2.000/10.000	250.000
1003610	1210 GLOBAL - 2.000/10.000	200.000
> 1010311	126 ORO - 2x1.000	20

> blister

PÁG							
8	13	28	29	30	31	32	33
42	43						

PÁG						
13	28	29	30	31	32	33

CÓDIGO	ARTÍCULO	PACK
1003932	CP700 ONDULADAS - 5.000	500.000

PÁG
9

OFFICE

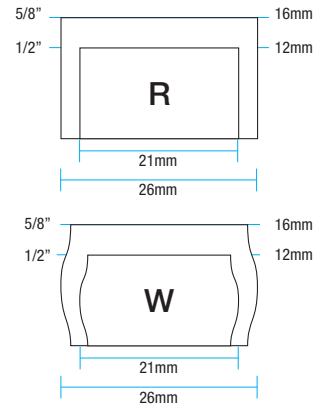
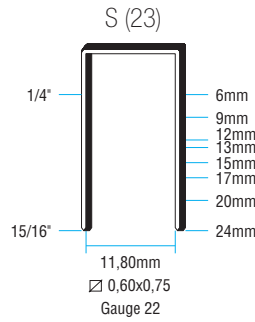
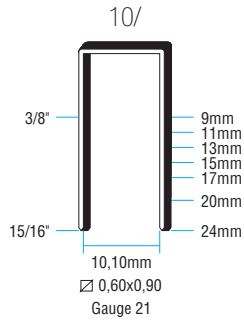

CÓDIGO	ARTÍCULO	PACK
1005101	10/9 ACERO - 5.000	75.000
1005103	10/11 ACERO - 5.000	65.000
1005105	10/13 ACERO - 5.000	55.000
1005107	10/15 ACERO - 5.000	50.000
1005109	10/17 ACERO - 2.000	44.000
1005111	10/20 ACERO - 2.000	40.000
1005113	10/24 ACERO - 2.000	26.000

PÁG		
35	37	39

CÓDIGO	ARTÍCULO	PACK
1005400	S6 ACERO - 1.000/10.000	100.000
1005415	S9 ACERO - 1.000/10.000	100.000
1005416	S12 ACERO - 1.000/10.000	100.000
1005417	S15 ACERO - 1.000	40.000
1005418	S17 ACERO - 1.000	34.000
1005419	S20 ACERO - 1.000	30.000
1005420	S24 ACERO - 1.000	26.000
1010410	S KIT - 25.000	1

PÁG				
35	37	39	40	41

PÁG		
61	63	64

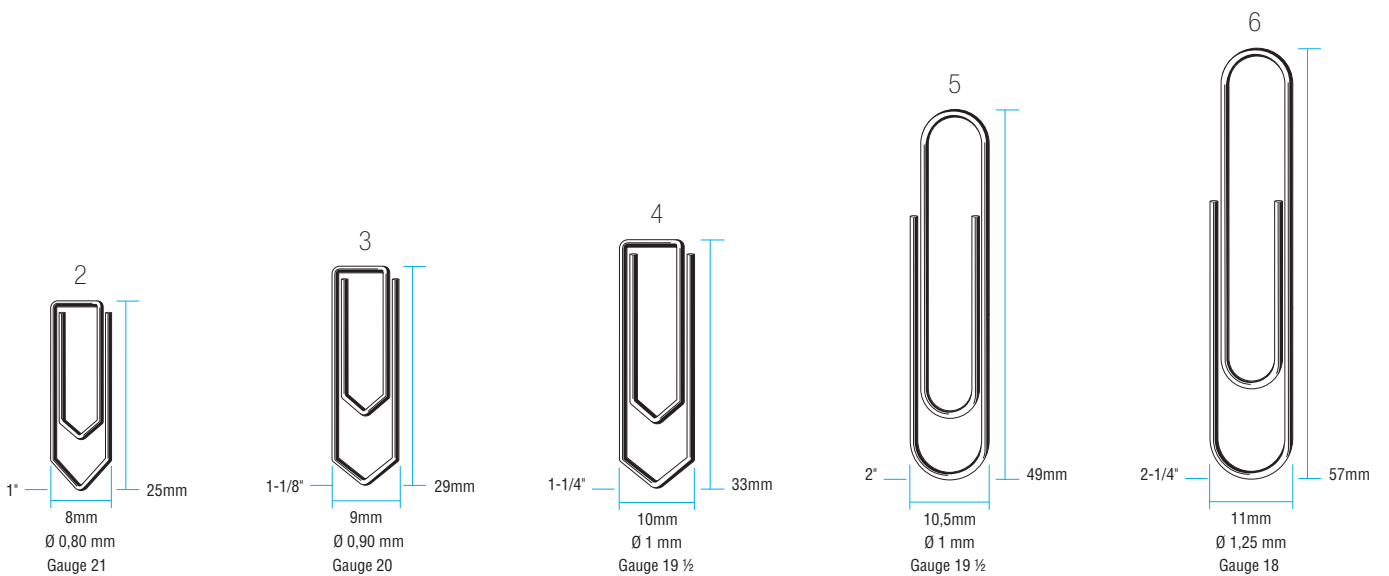

PÁG	
55	

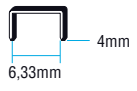
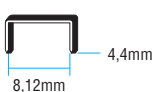
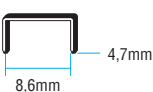
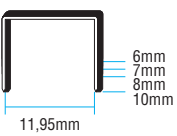
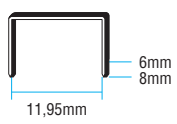
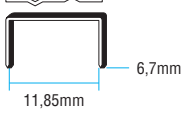
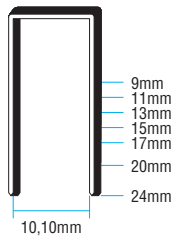
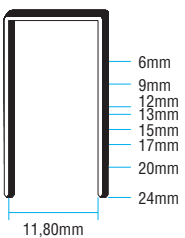
GRAPAS	ISABERG RAPID ESSELTE	LEBEZ	LEITZ	MAX	NOVUS	OMER	ZENITH
<p>64 (6/4)</p>  <p>jolly® punto universale oro puntofiro 64 64 GLOBAL 64</p>	21 - 51	P11	N8		7/45 - 111		130E - Z6
<p>8/4</p>  <p>8/4</p>	JAKY 8/4 BèBè				8/4		
<p>N10</p>  <p>N10</p>	N10 - 10/4	P10	N10	N10 - 1M	N10		
<p>24/</p>  <p>puntofiro 126 126 GLOBAL puntofiro 128 1210 GLOBAL</p>	24	24	24 - 25	N3 - 1M	24		515 - 115Z
<p>26/</p>  <p>26/</p>	26 - 66					26	512 - 112Z
<p>CP700</p>  <p>CP700</p>	41						
<p>10/</p>  <p>10/</p>							
<p>S (23)</p>  <p>S</p>	9 - 23	KH23	23	12FA - H	23		



Sistemas de fijación desde 1919



romeo maestri & figli s.p.a.

sistemi di cucitura a punto metallico - sistemas de grapado con grapa metálica

via Milano, 5 - 20010 Cornaredo (Mi) - Italy
tel +39 02.93619.1 - fax +39 02.93619.222

www.romeomaestri.com
sales@romeomaestri.it

