



# CATALOGO GENERALE

-  Fastening Line
-  Framing Line
-  Packaging Line



*una storia di Tradizione  
ed Eccellenza*

**Fastening Line**



**FISSATRICI MANUALI IN METALLO**

ROCAMA 10	4
ROCAMA JR 4.0	6
ROCAMA 14 4.0	8
ROCAMA 16	10
ROCAMA 20	12
M77 - M88	14

**FISSATRICI A MARTELLO**

MART 13 - MART 50	15
-------------------	----

**FISSATRICI MANUALI IN PLASTICA**

ROMA 10	16
ROMA 14	17
TECNICA 8	18
TECNICA 10	19
TECNICA 14	20
ROMATAK 10 4.0	22
ROMATAK 14 4.0	24



**FISSATRICI CORDLESS A BATTERIA**

ROCAMATICA	28
------------	----



**FISSATRICI ELETTRICHE**

ECOTAK	32
ELECTRO	34
LKT	36
ME	40

**CHIODATRICI ELETTRICHE**

LKT 30	38
ME 30	42



**FISSATRICI PNEUMATICHE**

RO-MA 8016	46
RO-MA 8016BL	47
RO-MA 6414	48
RO-MA 8414	49
RO-MA 9240	50
RO-MA 9025	51
RO-MA 90 COMBI	52

**CHIODATRICI PNEUMATICHE**

RO-MA 30TG	54
RO-MA 50TG	55
RO-MA 50 CONCRETE	56
RO-MA 55 MULTIBRAD	57
RO-MA 30/64	58
RO-MA 35/64	59
RO-MA 30/08	60
RO-MA 45/08	61

**BORCHIATRICI PER BORCHIE NASTRATE**

PN/2	62
------	----

**Framing Line**



**CHIODATRICI MANUALI PER CORNICI**

F12	66
F18	68
F15 FLEX	70

**CHIODATRICI PNEUMATICHE PER CORNICI**

FP12	67
FP18	69
FP15 FLEX	71

**Packaging Line**



**AGGRAFFATRICI MANUALI**

ROAMA MANUAL	74
ELPABOX BH	76
GF135 MECCANICA	80

**AGGRAFFATRICI PNEUMATICHE**

ROAMA PNEUMATIC	75
ELPABOX BA	77
RI-19/A	78
GF135 PNEUMATICA	81

**APPARECCHI SPECIALI**

RO-MA 73	79
----------	----



**TENDIREGGIA MANUALI**

MULTENS	84
B051	86
BAND-IT C001	88
FA/PLAST - MPL	90

**TENDIREGGIA A BATTERIA**

TB 1216	92
TB 1620	93

**PORTAREGGIA**

320 - M13-32	87
M4000 - PR/P	94

**KIT IMBALLAGGIO**

EASY PACK	95
-----------	----



**INCOLLATRICI**

MINIGRIP 7H	98
GRIP 11H	99
GRIP 15HL	100
GRIP 18HP	101
GRIP 20XP	102
M 195	103
M 220	104
M 3350	105
M 812	106
M812 MG	107
M12 / M7 / H12 / L12	108

**Consumables**

FASTENING	110
FRAMING	118
PACKAGING	119

ROCAMA 10	4
ROCAMA JR 4.0	6
ROCAMA 14 4.0	8
ROCAMA 16	10
ROCAMA 20	12
M77 - M88	14
MART 13 - MART 50	15
ROMA 10	16
ROMA 14	17
TECNICA 8	18
TECNICA 10	19
TECNICA 14	20
ROMATAK 10 4.0	22
ROMATAK 14 4.0	24





Corpo in lega speciale in alluminio. Caricamento sottobanchina. Impugnatura ergonomica. Assemblaggio

di telai e cornici. Per lavori di decorazione. Per fissare tappezzeria, ricoperture di divani e mobili. Ideale per

tutti i tipi di carta e stoffa, per allestimenti stands, arredamento negozi, interni di case, roulotte, campers.

### Metal Black

Regolatore di potenza.



Attacco rapido per la cintura.



Disponibile in:



CODICE	ARTICOLO		PACK
0104112	ROCAMA 10 METAL BLACK Mod. 107 S/A	Forest	5
0104110	ROCAMA 10 METAL BLACK Mod. 110 S/A	Forest-AP	5
0104113	ROCAMA 10 METAL BLACK Mod. 53 S/A	53/	5
0104111	ROCAMA 10 METAL BLACK Mod. 110/13 S/A	Forest-AP/13	5
> 0104310	ROCAMA 10 METAL BLACK Mod. 110 C/A	Forest-AP	5
> 0104311	ROCAMA 10 METAL BLACK Mod. 110/13 C/A	Forest-AP/13	5

> versione con appendice

MADE in ITALY



**ROCAMA 10 S/A**  
(frontale senza beccuccio)



Disponibile in 4 modelli.

**Mod. 107 S/A**

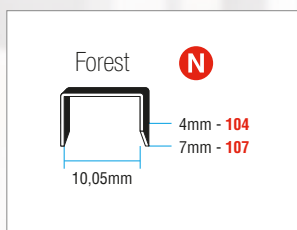

**Mod.110 S/A**

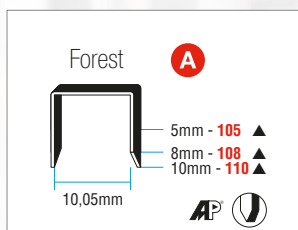

▲ Disponibili anche in versione AP

**Mod. 53 S/A**

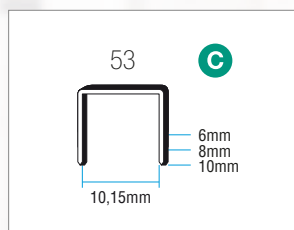

**Mod. 110/13 S/A**

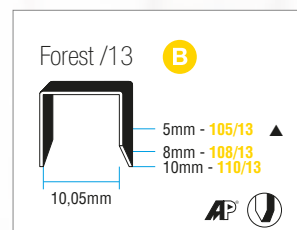

▲ Disponibili anche in versione AP

**ROCAMA 10 C/A**  
(frontale con beccuccio)



Disponibile in 2 modelli.

**Mod.110 C/A**

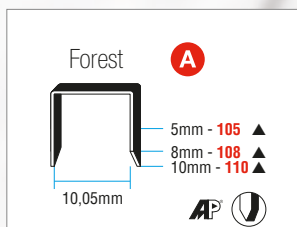

▲ Disponibili anche in versione AP

**Mod. 110/13 C/A**



▲ Disponibili anche in versione AP

**FOREST®** **AP®** **M53**

Si consiglia l'utilizzo di punti originali Maestri  
Pag. 110, 111



110 mm



0,67

Compatta, maneggevole,  
robusta. Molto potente.  
Massima capacità  
di infissione con

il minimo sforzo.  
Caricamento da sotto.  
Assemblaggio telai  
e cornici in legno.

Tappezzeria, ricopertura  
di divani e mobili.  
Fissaggio di tutti i tipi  
di carta e stoffa.

### Metal Black

Maniglia antiscivolo.



4 in 1.

Quattro diversi tipi di punti  
e chiodini metallici sono  
utilizzati senza necessità di  
regolazione.

Blocco maniglia.



Disponibile in:



CODICE	ARTICOLO					PACK
0101040	ROCAMA JR 4.0 Mod. 110	Forest-AP	53/	13/	M10	10
0101041	ROCAMA JR 4.0 Mod. 110/13	Forest-AP/13	50F/	53F/	M10	10



Disponibile in 2 modelli.

**Mod. 110**

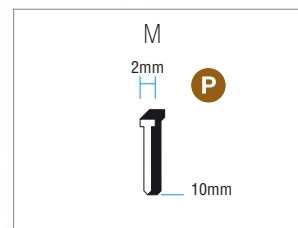
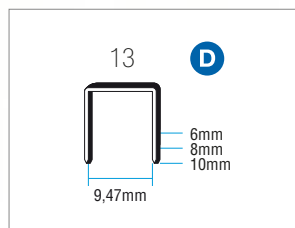
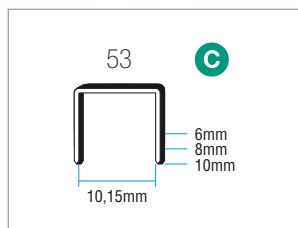
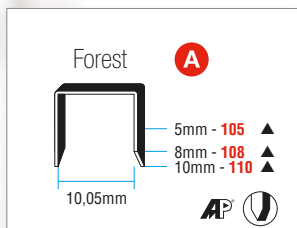

▲ Disponibili anche in versione AP

**Mod. 110/13**

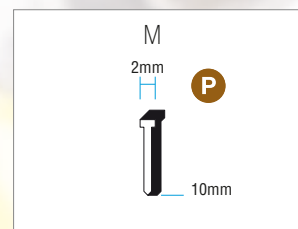
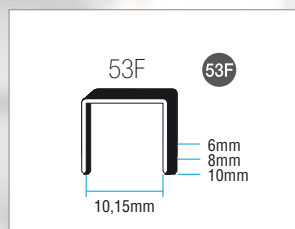
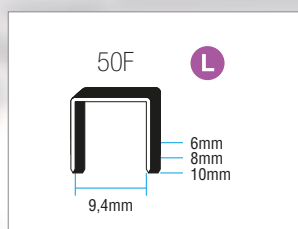
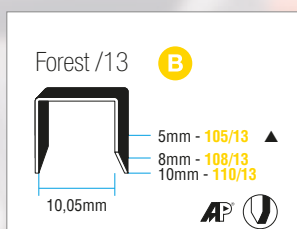

▲ Disponibili anche in versione AP

**FOREST® AP M53 M50F M13 CHIODINI M**

Si consiglia l'utilizzo di punti originali Maestri  
Pag. 110, 111, 112, 114

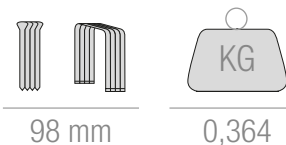

## FISSATRICI MANUALI IN METALLO

Assemblaggio di telai e cornici, lavori di decorazione. Per fissare tappezzeria, ricoperture di

divani e mobili. Per fissare tutti i tipi di carta e stoffa, zoccolini e profili in legno, per allestimenti stands,

arredamento negozi, interni di case, roulotte, campers.

### Metal Black

Regolatore di potenza.



Maniglia in gomma antiscivolo.



4 in 1.

Quattro diversi tipi di punti e chiodini metallici sono utilizzati senza necessità di regolazione.

Blocco maniglia.



Disponibile in:



CODICE	ARTICOLO	PACK				
0104530	ROCAMA 14 4.0 Mod. 114	AP-Forest	53/	13/	M15	5



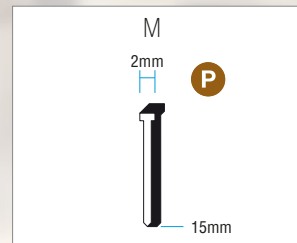
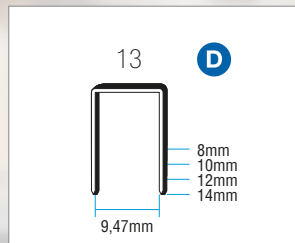
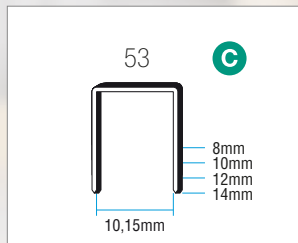
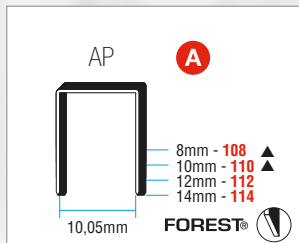

▲ Disponibili anche in versione FOREST

**FOREST®** | **AP®** | **M53** | **M13** | **CHIODINI M**

Si consiglia l'utilizzo di punti originali Maestri  
Pag. 110, 111, 114

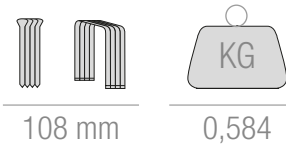

108 mm

0,584

Compatta, maneggevole,  
robusta.  
Molto potente.  
Massima capacità di

infissione con il minimo  
sforzo.  
Lavori di decorazione,  
tappezzeria, falegnameria,

fissaggio isolamenti, perline,  
pannelli in legno, coprifili,  
zocolini etc. Per fissare  
tutti i tipi di carta e stoffa.

### Metal Black

Regolatore di potenza.



Frontale removibile.

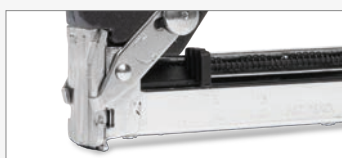

3 in 1.

Tre diversi tipi di punti e  
chiodini metallici sono  
utilizzati senza necessità di  
regolazione.

Blocco maniglia.



Disponibile in:



CODICE	ARTICOLO				PACK
0105001	ROCAMA 16 METAL BLACK Mod. 116B	AP-Forest	M13-15	W15	5
0105003	ROCAMA 16 METAL BLACK Mod. 53.16B	53/	M13-15	W15	5
0105005	ROCAMA 16 METAL BLACK Mod. 13.14	13/			5
0105225	ROCAMA 16 METAL BLACK Mod. 80.16	80/			5
> 0105004	ROCAMA 16 METAL BLACK Mod. 50F	50F/			5
> 0105210	ROCAMA 16 METAL BLACK Mod. 71	C800 (C) 3G - 71			5
> 0105232	ROCAMA 16 METAL BLACK Mod. 54	54/			5
> 0105227	ROCAMA 16 METAL BLACK Mod. 34	34/			5
> 0105229	ROCAMA 16 METAL BLACK Mod. 50	50/			5
> 0105214	ROCAMA 16 METAL BLACK OUTWARD CLINCH	ST50/			5
> 0105216	ROCAMA 16 METAL BLACK Mod. ST.50	ST50/			5

> versione speciale su richiesta

MADE in ITALY



Disponibile in 11 modelli.

**Mod. 116B**

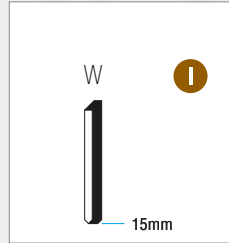
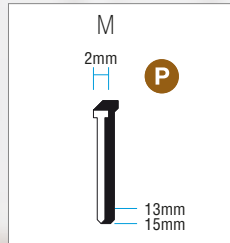
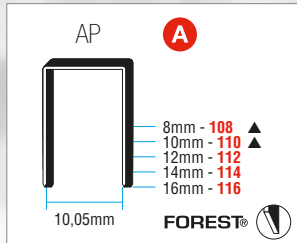

▲ Disponibili anche in versione FOREST

**Mod. 53.16B**

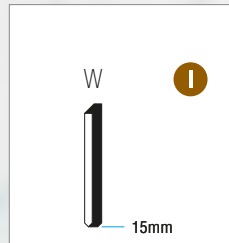
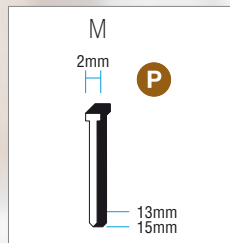
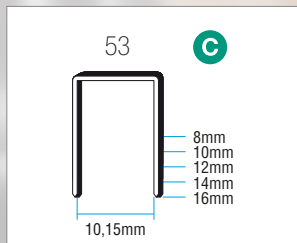

**Mod. 13.14**

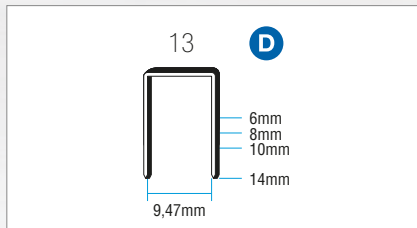

**Mod. 80.16**

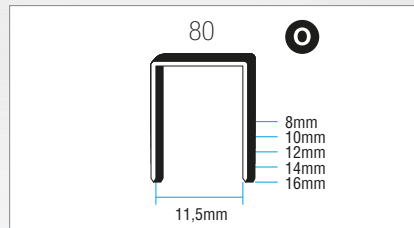

**Mod. 50F**

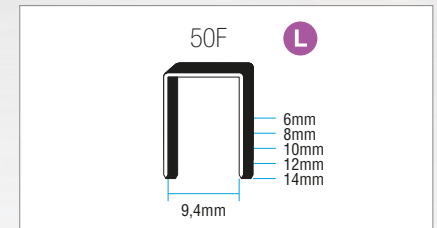

**Mod. 71**

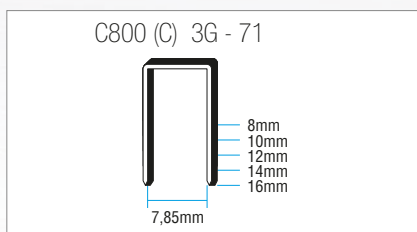

**Mod. 54**

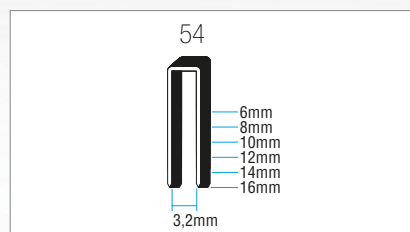

**Mod. 34**

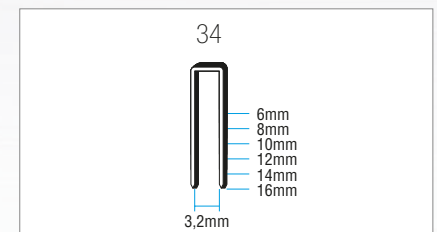

**Mod. 50**

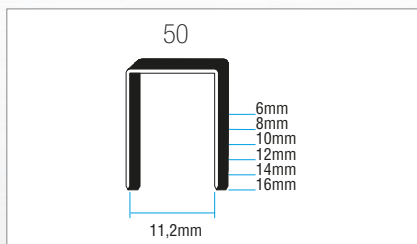

**Mod. ST50**

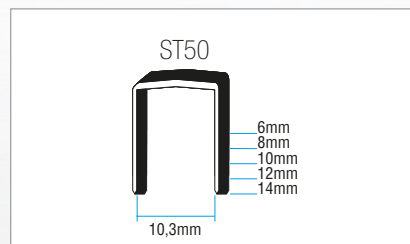

**Mod. OUTWARD CLINCH**

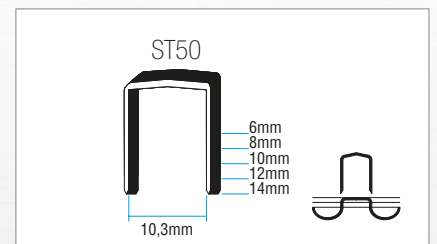

**FOREST® AP M53 M50F M13 80 CHIODINI W-M**

Si consiglia l'utilizzo di punti originali Maestri  
Pag. 110, 111, 112, 113, 114



130 mm



0,68

Compatta, maneggevole,  
robusta.  
Molto potente.  
Massima capacità di

infissione con il minimo  
sforzo.  
Lavori di decorazione,  
tappezzeria, falegnameria,

fissaggio isolamenti, perline,  
pannelli in legno, coprifili,  
zocolini etc. Per fissare  
tutti i tipi di carta e stoffa.

### Metal Black

Regolatore di potenza.



Frontale removibile.

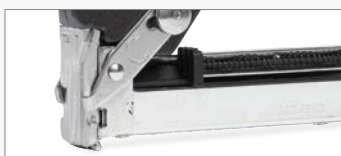

3 in 1.

Tre diversi tipi di punti e  
chiodini metallici sono  
utilizzati senza necessità di  
regolazione.

Blocco maniglia.



Disponibile in:



CODICE	ARTICOLO				PACK
0105503	ROCAMA 20 METAL BLACK Mod. 120B	AP-Forest	M20	W20	5
0105501	ROCAMA 20 METAL BLACK Mod. 53/20B	53/	M20	W20	5

MADE in ITALY



Disponibile in 2 modelli.

### Mod. 120B

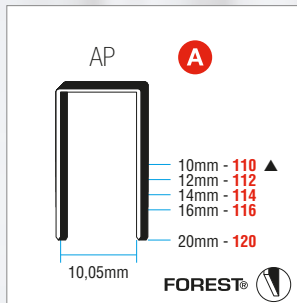

▲ Disponibili anche in versione FOREST

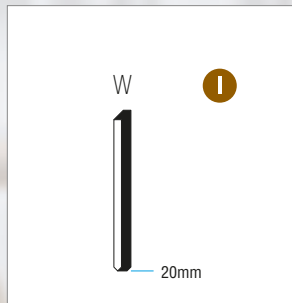
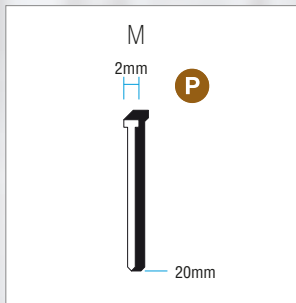

### Mod. 53/20B

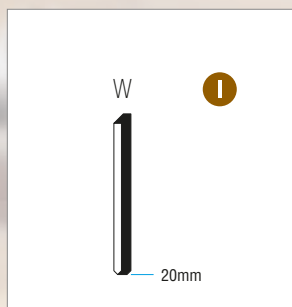
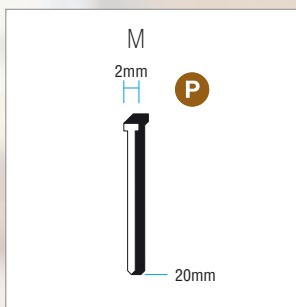
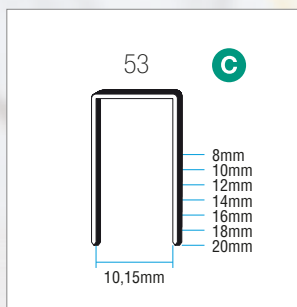

**FOREST®** **AP®** **M53** **CHIODINI W-M**

Si consiglia l'utilizzo di punti originali Maestri  
Pag. 110, 111, 114

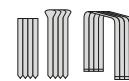

130 mm

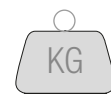

0,69

## M77 - M88

Fissatrice manuale in acciaio cromato con maniglia rivestita in plastica isolante.

Ideale per fissare cavi televisivi e telefonici Ø 5 mm (M77) e Ø 6,5 mm (M88).

Impugnatura anatomica in gomma.



Blocco maniglia.



Disponibile in:



CODICE	ARTICOLO		PACK
0121301	M 77	77/	4
0121302	M 88	88/	4



Disponibile in 2 modelli.

Mod. M 77

Mod. M 88

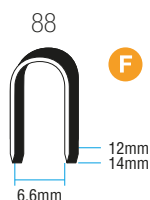
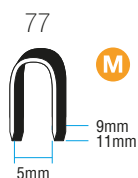

**77/ 88/**

Si consiglia l'utilizzo di punti originali Maestri  
Pag. 112

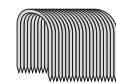

120 mm



KG

0,85



# FISSATRICI A MARTELLO



*Fissatrice a martello per punti metallici, studiata per essere utilizzata per fissare materiali di*

*isolamento, di copertura, carta catramata, etichette su casse, reti e casse per frutta.*

## MART 13 MART 50

CODICE	ARTICOLO		PACK
0190162	MART 13	13/	6
0190160	MART 50	50F/	4



**Mod. MART 13**

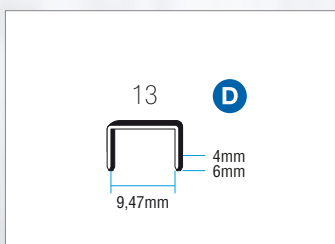

Disponibile in:

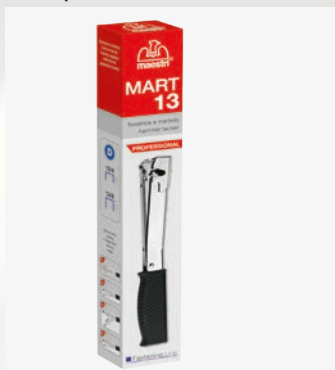

**Mod. MART 50**

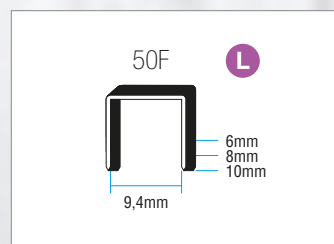

Disponibile in:



**M13**



124 mm



KG

0,40

Si consiglia l'utilizzo di punti originali Maestri  
Pag. 111

**M50F**



210 mm



KG

0,98

Si consiglia l'utilizzo di punti originali Maestri  
Pag. 111

## FISSATRICI MANUALI IN PLASTICA

Per lavori di decorazione.  
Fissaggio di tappezzeria,  
ricoperture di divani e  
mobili.

Per fissare tutti i tipi di  
carta e stoffa. Rivestire  
sedie e decorare vetrine.  
Arredamento negozi.

Carica da sottobanchina.

Corpo in ABS.



Blocco maniglia.



Disponibile in:



CODICE	ARTICOLO		PACK
0112025	ROMA 10	53/	8

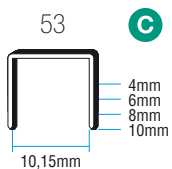

**M53**

Si consiglia l'utilizzo di punti originali Maestri  
Pag. 111



80 mm



0,25

Per lavori di decorazione.  
Fissaggio di tappezzeria,  
ricoperture di divani e mobili.  
Per fissare tutti i tipi

di carta e stoffa. Rivestire  
sedie e decorare vetrine.  
Fissaggio di zoccolini,  
profili in legno, pannelli.

Impugnatura pratica  
ed ergonomica.  
Carica da sottobanchina.  
Blocco maniglia.

# ROMA 14

CODICE	ARTICOLO			PACK
0114023	ROMA 14	53/	M15	8

Corpo in ABS.



Regolatore di potenza.



Disponibile in:

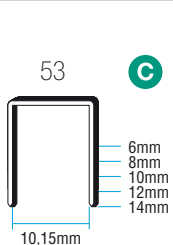

## M53 CHIODINI M

Si consiglia l'utilizzo di punti originali Maestri  
Pag. 111, 114

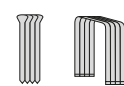

105 mm

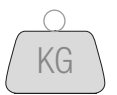

0,42

## FISSATRICI MANUALI IN PLASTICA

Per lavori di decorazioni e fissaggio di tappezzeria, ricoperture di divani e mobili.

Per fissare tutti i tipi di carta e stoffa, rivestire sedie e decorare vetrine. *Carica da sotto.*

Corpo in ABS antiurto 20% fibre di vetro e frontale in acciaio.



Blocco maniglia.



Disponibile in:



CODICE	ARTICOLO	PACK
0112010	TECNICA 8 Mod. 108	Forest-AP 10

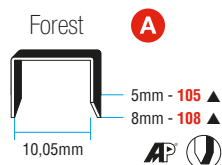

▲ Disponibili anche in versione AP

**FOREST®** | **AP®**

Si consiglia l'utilizzo di punti originali Maestri  
Pag. 110, 111



80 mm



KG

0,33

CODICE	ARTICOLO		PACK
0113086	<b>TECNICA 10 Mod. 110</b>	Forest-AP	10
0113087	<b>TECNICA 10 Mod. 110/13</b>	Forest-AP/13	10

Corpo in ABS antiurto 20% fibre di vetro e frontale in acciaio.



Blocco maniglia.



Disponibile in:



Disponibile in 2 modelli.

**Mod. 110**

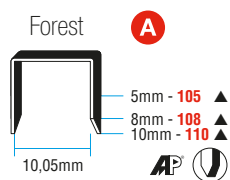

**Mod. 110/13**

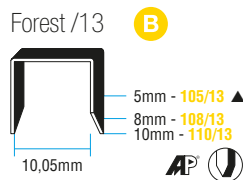

**FOREST® AP®**

Si consiglia l'utilizzo di punti originali Maestri  
Pag. 110, 111



100 mm



0,43

*Per lavori di decorazione.  
Fissaggio di tappezzeria.  
Per fissare tutti i tipi  
di carta e stoffa.*

*Rivestire sedie e decorare  
vetrine. Fissaggio di  
zoccolini, profili in legno,  
pannelli.*

*Caricamento da  
sottobanchina.*

Corpo in nylon antiurto 30%  
fibre di vetro.



Regolatore di potenza.



Blocco maniglia.



Disponibile in:



CODICE	ARTICOLO			PACK
0114002	<b>TECNICA 14 Mod. 114</b>	AP-Forest	M15	10
0114003	<b>TECNICA 14 Mod. 53.14</b>	53/	M15	10



Disponibile in 2 modelli.

**Mod. 114**

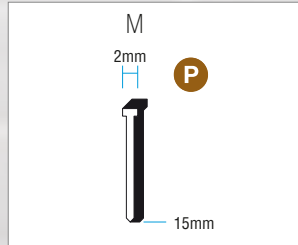
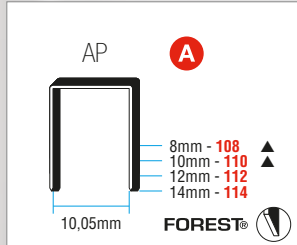

▲ Disponibili anche in versione FOREST

**Mod. 53.14**

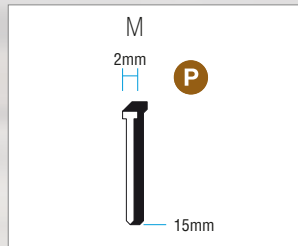
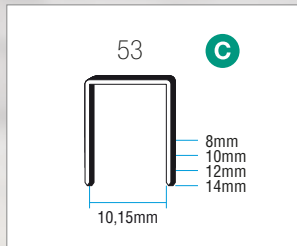

**TECNICA family:**

**TECNICA 108** A 0,330 (ca) 80mm 85 pcs (ca) 92x28x156mm

Corpo in ABS arricchito 20% fibre di vetro.  
High Impact body in ABS 20% reinforced fiberglass.  
Corps en ABS 20% chargé de fibre de verre.  
Cuerpo de ABS cargado en un 20% con fibras de vidrio.  
Schlagkörper ABS-Gehäuse, 20% glasfaserverstärkt.  
Αιχμηρός σώμας από ABS με 20% ενισχυμένο φερίσμα γυαλίου.

**TECNICA 110** A 0,430 (ca) 100mm (ca) 110 pcs - Mod. 110 125 pcs - Mod. 53.10 80 pcs - Mod. 110.13

Corpo in nylon arricchito 30% fibre di vetro.  
High impact body in nylon 30% reinforced fiberglass.  
Corps en nylon 30% chargé de fibre de verre.  
Cuerpo de nylon cargado en un 30% con fibras de vidrio.  
Schlagkörper, 30% glasfaserverstärkt Gehäuse.  
Αιχμηρός σώμας από νυλόν με 30% ενισχυμένο φερίσμα γυαλίου.

**TECNICA 110/13** B 0,310 (ca) 110mm (ca) 110 pcs - Mod. 110/13 125 pcs - Mod. 53.14

**TECNICA 53/14** C 0,520 (ca) 100mm -100 pcs (ca) 109x34x174mm

Corpo in nylon arricchito 30% fibre di vetro.  
High impact body in nylon 30% reinforced fiberglass.  
Corps en nylon 30% chargé de fibre de verre.  
Cuerpo de nylon cargado en un 30% con fibras de vidrio.  
Schlagkörper, 30% glasfaserverstärkt Gehäuse.  
Αιχμηρός σώμας από νυλόν με 30% ενισχυμένο φερίσμα γυαλίου.

Caricamento / Loading / Chargement

1

Blocco maniglia / Handle lock (1-2-3)

2

Blocco alveare / Handle lock (1-2-3)

3

Blocco alveare / Handle lock (1-2-3)

Caricamento / Loading / Chargement

1

Blocco maniglia / Handle lock (1-2-3)

2

Blocco alveare / Handle lock (1-2-3)

3

Blocco alveare / Handle lock (1-2-3)

**FOREST®** | **AP®** | **M53** | **CHIODINI M**

Si consiglia l'utilizzo di punti originali Maestri  
Pag. 110, 111, 114

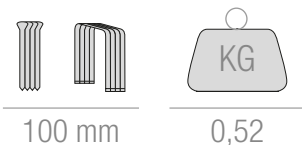

## FISSATRICI MANUALI IN PLASTICA

Compatta, maneggevole, robusta. Molto potente. Massima capacità di infissione con il minimo

sforzo. Assemblaggio telai e cornici in legno. Lavori di decorazione, fissaggio di tappezzeria, ricopertura di

divani e mobili. Fissaggio di tutti i tipi di carta e stoffa.

### 4 in 1.

Quattro diversi tipi di punti e chiodini metallici sono utilizzati senza necessità di regolazione.

Corpo in nylon  
30% fibre di vetro.



### Blocco maniglia.



### Disponibile in:



CODICE	ARTICOLO					PACK
0113095	ROMATAK 10 4.0 Mod. 110	Forest-AP	53/	13/	M10	10
0113096	ROMATAK 10 4.0 Mod. 110/13	Forest-AP/13	50F/	53F/	M10	10





Disponibile in 2 modelli.

### Mod. 110

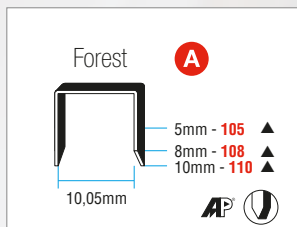

▲ Disponibili anche in versione AP

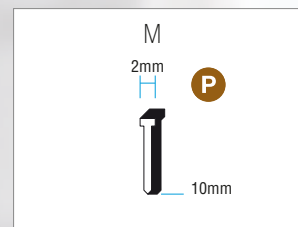
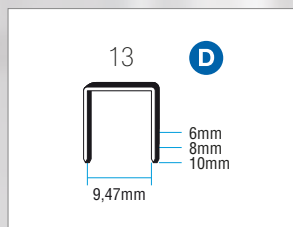
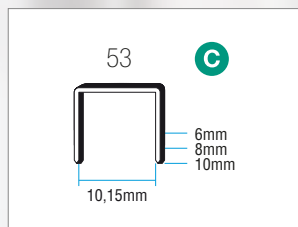

### Mod. 110/13

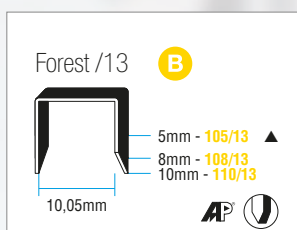

▲ Disponibili anche in versione AP

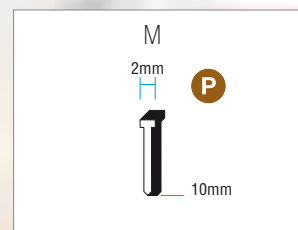
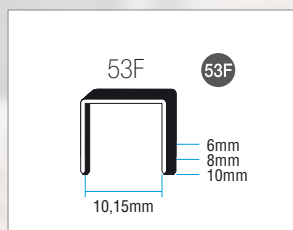
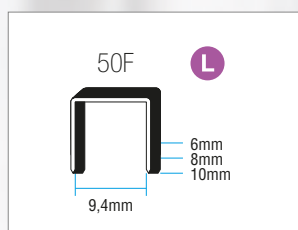

**FOREST®** | **AP®** | **M53** | **M50F** | **M13** | **CHIODINI M**

Si consiglia l'utilizzo di punti originali Maestri  
Pag. 110, 111, 112, 114



98 mm



0,248

## FISSATRICI MANUALI IN PLASTICA

Compatta, maneggevole, robusta. Molto potente. Massima capacità di infissione con il minimo

sforzo. Assemblaggio telai e cornici in legno. Lavori di decorazione, fissaggio di tappezzeria, ricopertura di

divani e mobili. Fissaggio di tutti i tipi di carta e stoffa.

### 4 in 1.

Quattro diversi tipi di punti metallici sono utilizzati senza necessità di regolazione.

Regolatore di potenza.



Blocco maniglia.



Disponibile in:



CODICE	ARTICOLO					PACK
0114011	ROMATAK 14 4.0 Mod. 114	AP-Forest	53/	13/	M15	10



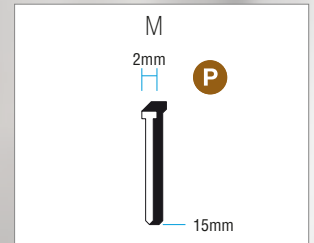
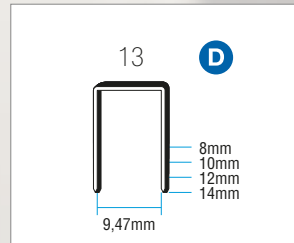
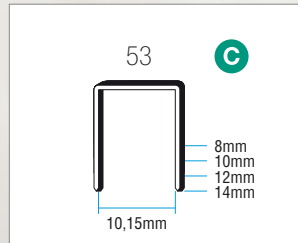
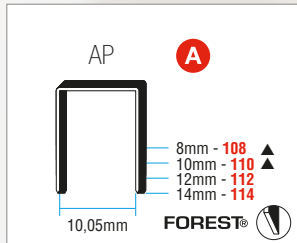

▲ Disponibili anche in versione FOREST

**FOREST®** | **AP®** | **M53** | **M13** | **CHIODINI M**

Si consiglia l'utilizzo di punti originali Maestri  
 Pag. 110, 111, 114

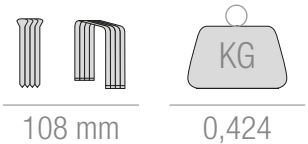



FISSATRICI CORDLESS A BATTERIA



*Fissatrice cordless leggera e compatta. Progettata con una batteria ricaricabile con tecnologia al litio, integrata nel corpo macchina, che garantisce una durata lunga nel tempo. Guscio in plastica costruito in tecnopolimero ad alta resistenza. Comodo pulsante carrello per un caricamento da*



**3.7V**  
Li-ION BATTERY  
TECHNOLOGY

Impugnatura in gomma antiscivolo e regolatore di potenza.



Grilletto di sicurezza.



Luce di lavoro LED.



Caratteristiche:

Rumorosità: LwA 80,1 dBA  
LpA 69,1 dBA

Vibrazioni: 1,018 m/s<sup>2</sup>

Disponibile in:



inclusi:

- ▶ 5.000 punti 108 Forest
- ▶ 1 Carica batteria
- ▶ 1 Cavo di ricarica
- ▶ 1 Occhiali di protezione

Conforme alle direttive:

- ▶ ROHS
- ▶ 2006/42/CE



CODICE	ARTICOLO			PACK
0130001	ROCAMATICA Mod. 114	AP-Forest	M15	1



sottobanchina facile e veloce. Ideale per il bricolage e per tutti i lavori di fissaggio: decorazioni,

assemblaggi di telai e cornici, tappezzeria, ricopertura di mobili e divani, installazione di

isolamenti, allestimenti di stand fieristici, per interni di roulotte, camper e nautici.

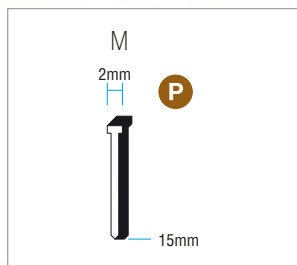
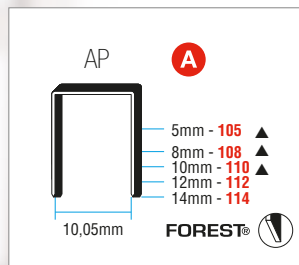

▲ Disponibili anche in versione FOREST



**FOREST®** **AP®** **CHIODINI M**

Si consiglia l'utilizzo di punti originali Maestri  
Pag. 110, 111, 114



110 mm



BATTERIA AL LITIO  
3,7V 2000mAh



1,05

ECOTAK	32
ELECTRO	34
LKT	36
LKT 30	38
ME	40
ME 30	42







*Veloce, leggera, robusta, elettronica d'avanguardia, sistema di sicurezza brevettato.*

*Impugnatura adattabile ad utilizzi diversi. Per assemblaggio di telai e cornici.*

*Lavori di decorazione. Per fissare tappezzeria, ricopertura di mobili e divani. Installazioni*

## Hi-Tech ELECTRONIC

Corpo in tecnopolimero.



Caratteristiche:

Rumorosità: LpA 73,9 dBA  
LwA 85 dBA

Vibrazioni: 5,17 m/s<sup>2</sup>

Disponibile in:



Conforme alle direttive:

- ▶ ROHS
- ▶ 2006/42/CE



CODICE	ARTICOLO				PACK
0140301	<b>ECOTAK Mod. 114 B</b>	AP-Forest	M15	W15	1
0140001	<b>ECOTAK Mod. 53.14 B</b>	53/	M15	W15	1

MADE in ITALY



isolamenti. Allestimenti  
stands ed arredamenti  
negozi. Interni roulottes,  
campers, nautica.

Disponibile in 2 modelli.

### Mod. 114B

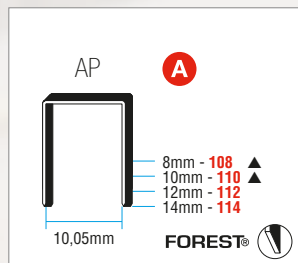

▲ Disponibili anche in versione  
FOREST

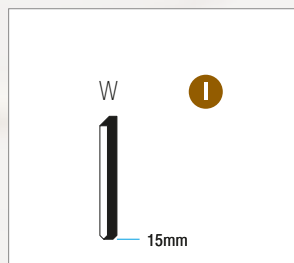
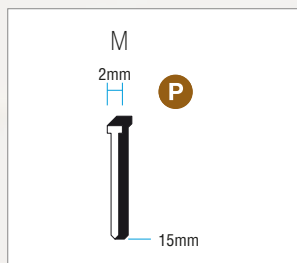

### Mod. 53.14B

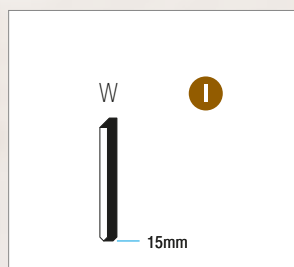
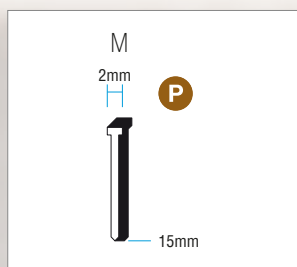
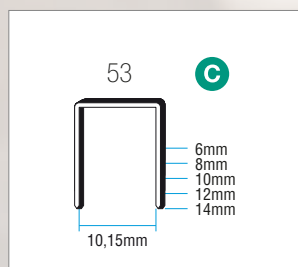

Cavo elettrico 2,5m / 98" fornito con spina elettrica a scelta:



**FOREST®** **AP®** **M53** **CHIODINI W-M**

Si consiglia l'utilizzo di punti originali Maestri  
Pag. 110, 111, 114

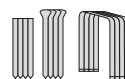

110 mm



AC220/240V  
50-60 Hz

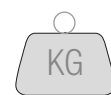

0,83

*Veloce, leggera, robusta. Guscio in tecnopolimero ad alta resistenza. Dotata di interruttore*

*on/off e manopola di regolazione della potenza di sparo. Caricamento da sottobanchina. Ideale*

*per tutte le applicazioni di fissaggio come decorazioni, allestimenti stand, assemblaggi di telai,*

## Hi-Tech ELECTRONIC

Sicura a tastatore.



Impugnatura in gomma antiscivolo.



Manopola di regolazione della potenza.



Caratteristiche:

Rumorosità: LwA 95,8 dBA  
LpA 84,8 dBA

Vibrazioni: 2,929 m/s<sup>2</sup>

Disponibile in:



Conforme alle direttive:

- ▶ ROHS
- ▶ 2006/42/CE



CODICE	ARTICOLO			PACK
0140404	ELECTRO 53.14	53/	M15	1



*infissi e tappezzerie.  
Interni roulotte, campers,  
nautica.*

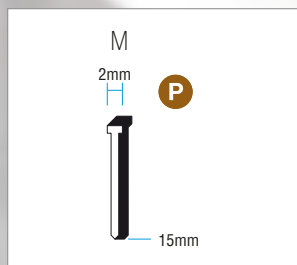
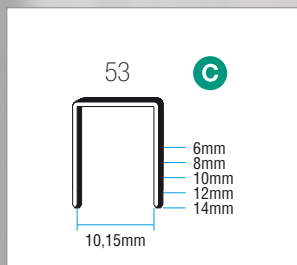

## M53 CHIODINI M

Si consiglia l'utilizzo di punti originali Maestri  
Pag. 111, 114



110 mm



AC220/240V  
50 Hz



KG

0,650

Leggera, veloce, potente.  
Assemblaggio di telai e  
cornici. Lavori di decorazione.  
Tappezzerie, ricopertura di

divani e mobili. Installazione  
isolamenti. Allestimenti stand  
ed arredamento negozi.  
Interni roulottes, camper

e nautica. Caricamento  
posteriore con spingipunti  
incorporato. Sicurezza contro  
lo sparo accidentale.

### Extreme PROFESSIONAL

Grilletto di sicurezza e  
frontale removibile.



Impugnatura in gomma  
antiscivolo.



Corpo in nylon 30% fibre di  
vetro ad alta resistenza.



Caratteristiche:

Rumorosità: LwA 91,5 dBA  
LpA 80,7 dBA

Vibrazioni: 4,96 m/s<sup>2</sup>

Disponibile in:



Conforme alle direttive:

- ▶ ROHS
- ▶ 2006/42/CE



CODICE	ARTICOLO			PACK
0141232	LKT Mod. 120	AP-Forest	AP19	1
0141234	LKT Mod. 53	53/	AP19	1
0141236	LKT Mod. 80 Brad	80/	AP19	1
0141238	LKT Mod. 13	13/		1
0141242	LKT Mod. 50F	50F/		1
0141240	LKT Mod. 4/606 COMBI	606/	AP 15-19-25	1

MADE in ITALY



Studiata per operare sui prodotti finiti. Non lascia alcuna impronta d'appoggio.

Disponibile in 6 modelli.

### Mod. 120

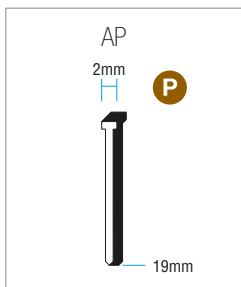
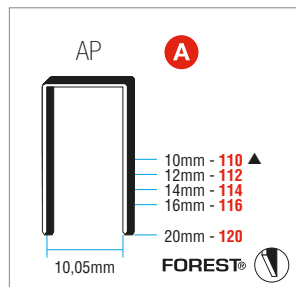

### Mod. 53

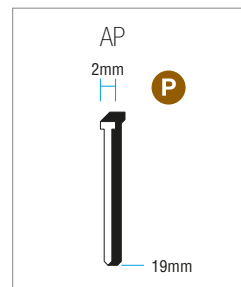
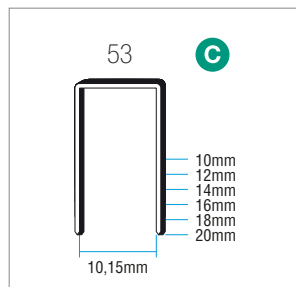

▲ Disponibili anche in versione FOREST

### Mod. 80 Brad

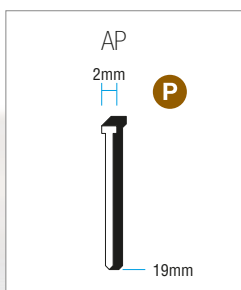
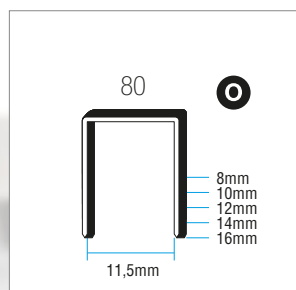

### Mod. 13

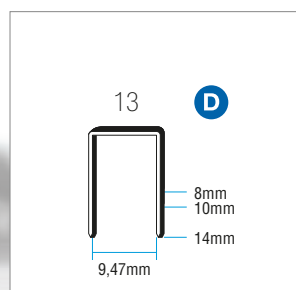

### Mod. 4/606 COMBI

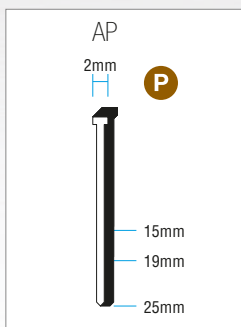
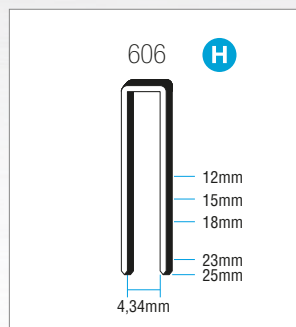

### Mod. 50F

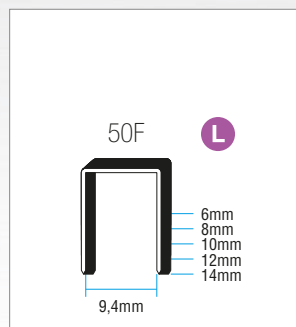

Cavo elettrico 3,5m / 138" fornito con spina elettrica a scelta:



**FOREST® AP M53 80 M13 M50F 606**

Si consiglia l'utilizzo di punti originali Maestri  
Pag. 110, 111, 112, 113, 114

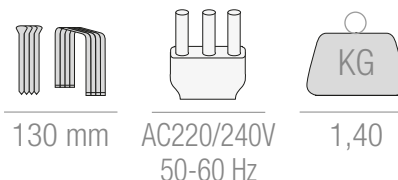

*Leggera, veloce, potente.  
Studiata appositamente  
per operare sui prodotti  
finiti senza lasciare alcuna*

*impronta di appoggio.  
Speciale per montatori  
di infissi, profili di porte e  
finestre, perlinature etc.*

*Per legni teneri e duri.*

### Extreme PROFESSIONAL

Grilletto di sicurezza e frontale removibile.



Impugnatura in gomma antiscivolo.



Corpo in nylon 30% fibre di vetro ad alta resistenza.



Caratteristiche:

Rumorosità: LpA 82,9 dBA  
LwA 94 dBA

Vibrazioni: 4,92 m/s<sup>2</sup>

Disponibile in:



Conforme alle direttive:

- ▶ ROHS
- ▶ 2006/42/CE



CODICE	ARTICOLO	PACK
0145110	LKT 30	AP 15-19-25-30 1

MADE in ITALY





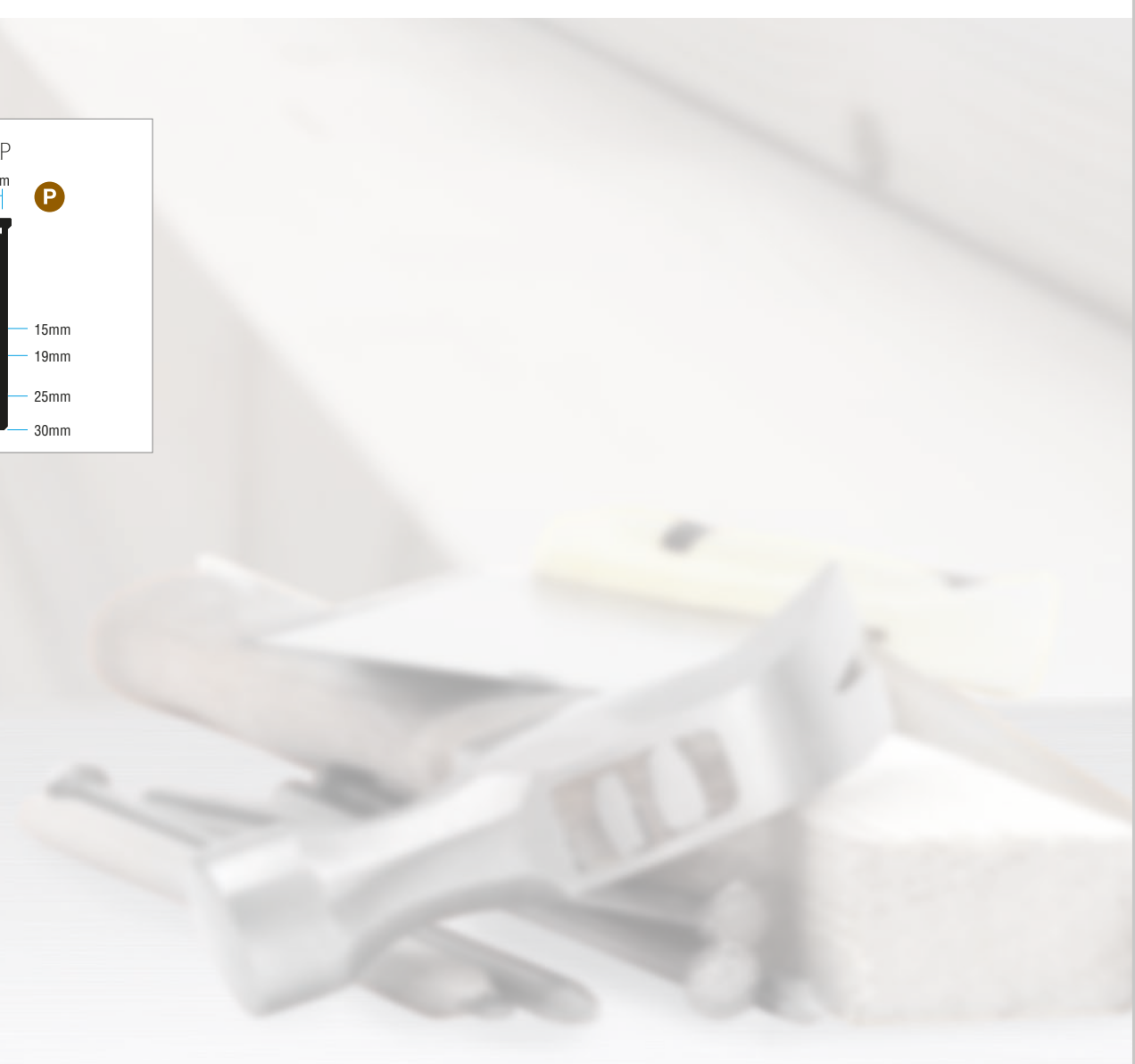
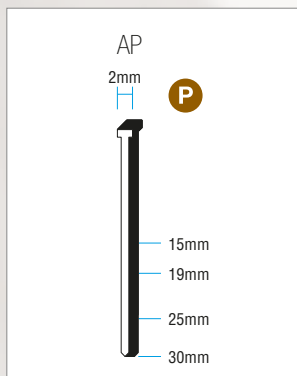

Cavo elettrico 3,5m / 138" fornito con spina elettrica a scelta:



Si consiglia l'utilizzo di punti originali Maestri  
Pag. 114



130 mm



AC220/240V  
50-60 Hz

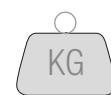

1,40

Attrezzo professionale ideale per l'assemblaggio di telai, cornici e tappezzeria murale.

Lavori di decorazione e riparazioni mobili. Fissaggio di cornici su mobili e serramenti,

di coprifili e perline. Allestimenti stands, arredamenti negozi.

### Extreme PROFESSIONAL

Grilletto di sicurezza e frontale removibile.



Corpo in nylon 30% fibre di vetro ad alta resistenza.



Caratteristiche:

Rumorosità: LwA 91,5 dBA  
LpA 80,7 dBA

Vibrazioni: 4,96 m/s<sup>2</sup>

Disponibile in:



Conforme alle direttive:

- ▶ ROHS
- ▶ 2006/42/CE



CODICE	ARTICOLO			PACK
0211113	ME80	80/		1
0211150	ME80 BRAD	80/	AP19	1
0211130	ME4000	4000/		1
0212110	ME 606	606/	AP 15-19-25	1
0211114	ME80 - 110V	80/		1
0213305	ME3G - 110V	C800 (C) 3G - 71		1
0211140	ME54 - 110V	54/		1
0141011	ME50F - 110V	50F/		1
0211136	ME50 - 110V	50/		1

MADE in ITALY



Disponibile in 8 modelli.

Mod. 80

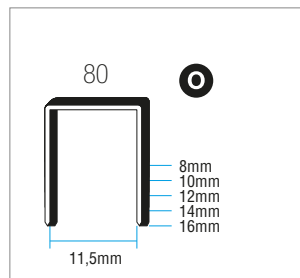

Mod. 50F

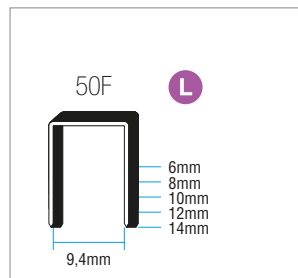

Mod. 4000

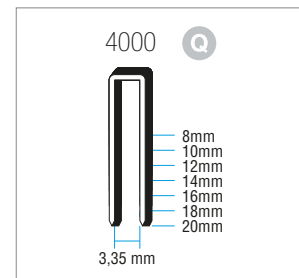

Mod. 80 Brad

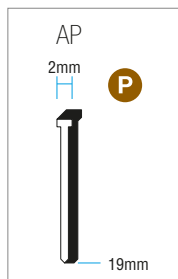
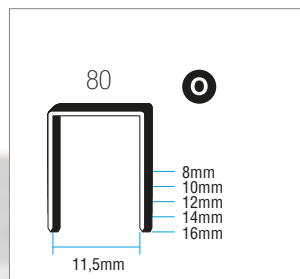

Mod. 3G

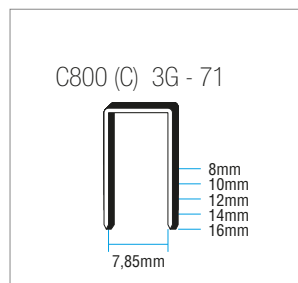

Mod. 54

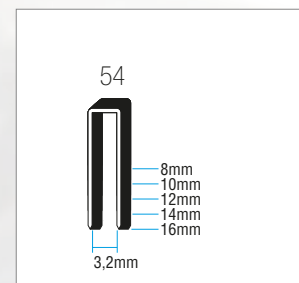

Mod. 606

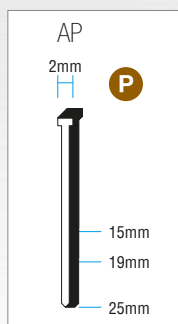
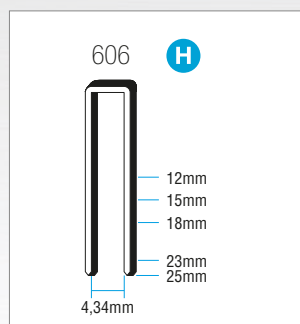

Mod. 50

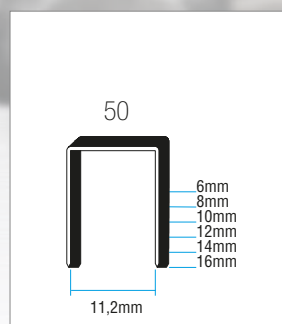

Mod. 33

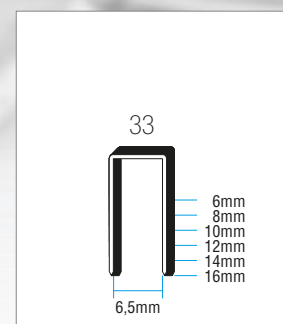

Cavo elettrico 3,5m / 138" fornito con spina elettrica a scelta:



**AP** 80 M50F 606 4000 C800

Si consiglia l'utilizzo di punti originali Maestri  
Pag. 111, 112, 113, 114

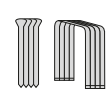

130 mm



AC110/120V  
AC220/240V  
50-60 Hz

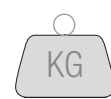

1,40

Studiata per operare su prodotti finiti senza lasciare alcuna impronta d'appoggio. Speciale

per montatori di infissi, profili di porte e finestre, perlinature, ecc. e per tutti i posatori in genere: opera

indifferentemente su legni teneri e duri, in sottofilo.

### Extreme PROFESSIONAL

Grilletto di sicurezza e frontale removibile.



Corpo in nylon 30% fibre di vetro ad alta resistenza.



Caratteristiche:

Rumorosità: LpA 82,9 dBA  
LwA 94 dBA

Vibrazioni: 4,92 m/s<sup>2</sup>

Disponibile in:



Conforme alle direttive:

- ▶ ROHS
- ▶ 2006/42/CE



CODICE	ARTICOLO		PACK
0215121	ME30	AP 15-19-25-30	1

MADE in ITALY



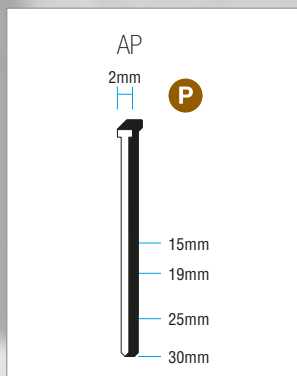

Cavo elettrico 3,5m / 138" fornito con spina elettrica a scelta:



Si consiglia l'utilizzo di punti originali Maestri  
Pag. 114



130 mm



AC110/120V  
AC220/240V  
50-60 Hz

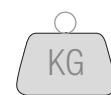

1,40

RO-MA 8016	46
RO-MA 8016BL	47
RO-MA 6414	48
RO-MA 8414	49
RO-MA 9240	50
RO-MA 9025	51
RO-MA 90 COMBI	52
RO-MA 30TG	54
RO-MA 50TG	55
RO-MA 50 CONCRETE	56
RO-MA 55 MULTIBRAD	57
RO-MA 30/64	58
RO-MA 35/64	59
RO-MA 30/08	60
RO-MA 45/08	61
PN/2	62





## FISSATRICI PNEUMATICHE PER PUNTI LEGGERI

*Potenti, leggere, compatte. Ideali per tappezzeria murale. Ricopertura di poltrone e divani.* *Lavorazioni di decorazione. Installazione isolamenti termici ed acustici. Interni di roulotte, camper, nautica.* *Caricamento da sottobanchina.*

Impugnatura in gomma.



Caratteristiche:

Consumo d'aria  
a 60 cicli/min: 51 ℓ/min

Rumorosità: LwA 96,4 dBA

Vibrazioni: 1,9 m/s<sup>2</sup>

Disponibile in:



Conforme  
alle direttive:

► 2006/42/CE



CODICE	ARTICOLO		PACK
0153143	RO-MA 8016 RED LINE	80/	1

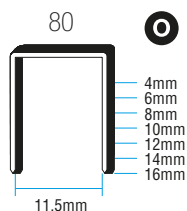

**80**

Si consiglia l'utilizzo di punti originali Maestri  
Pag. 112



130 mm



1



ATM

4/8



# RO-MA 8016 BL

CODICE	ARTICOLO	PACK
0231522	RO-MA 8016 BL	80/ 1

Impugnatura in gomma.



Grilletto di sicurezza.



Caratteristiche:

Consumo d'aria  
a 60 cicli/min: 31,6 l/min  
a 6,2bar (10psi)

Rumorosità: LwA 90 dBA

Vibrazioni: 0,7 m/s<sup>2</sup>

Disponibile in:



Conforme  
alle direttive:

► 2006/42/CE



◀ Il frontale lungo e sottile permette di accedere con facilità senza impedire la visibilità sulle superfici di lavoro difficili da raggiungere.

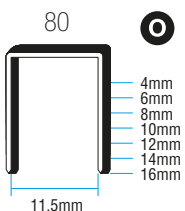

**80**

Si consiglia l'utilizzo di punti originali Maestri  
Pag. 112



130 mm

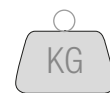

1



6/7

## FISSATRICI PNEUMATICHE PER PUNTI LEGGERI

Potenti, leggere, compatte.  
Ideali per tappezzeria  
murale. Ricopertura  
poltrone e divani.

Lavorazioni di decorazione.  
Installazione isolamenti  
termici ed acustici. Interni  
roulottes, camper, nautica.

Caricamento da  
sottobanchina.

Impugnatura in gomma.



Caratteristiche:

Consumo d'aria  
a 60 cicli/min: 85ℓ/min  
a 6,2 bar (10psi)

Rumorosità: LpA 88 dBA

Vibrazioni: 2,5 m/s<sup>2</sup>

Disponibile in:



Conforme  
alle direttive:

► 2006/42/CE



CODICE	ARTICOLO	PACK	
0153145	RO-MA 6414	64/	1

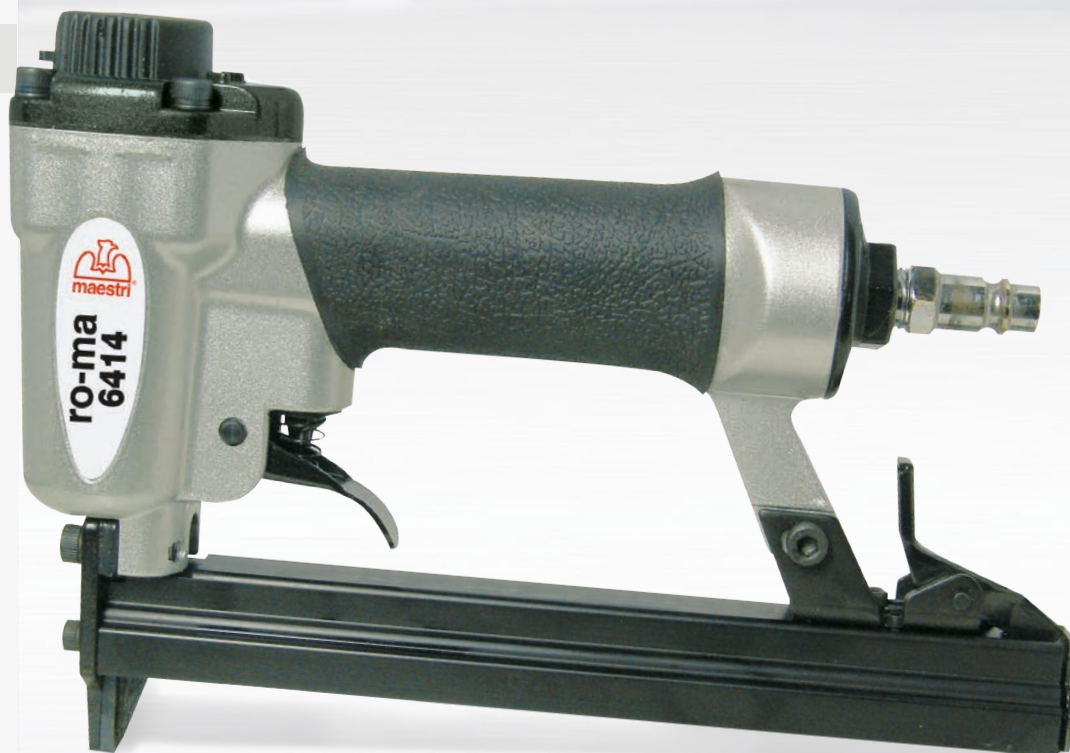

64

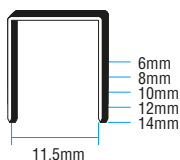

**64**

Si consiglia l'utilizzo di punti originali Maestri  
Pag. 112



150 mm



0,90



4/7

# RO-MA 8414

CODICE	ARTICOLO	PACK	
0153147	RO-MA 8414	84/	1

Impugnatura in gomma.



Caratteristiche:

Consumo d'aria  
a 60 cicli/min: 85 ℓ/min  
a 6,2 bar (10psi)

Rumorosità: LwA 88 dBA

Vibrazioni: 2,5 m/s<sup>2</sup>

Disponibile in:



Conforme  
alle direttive:

► 2006/42/CE

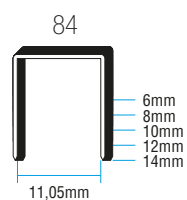
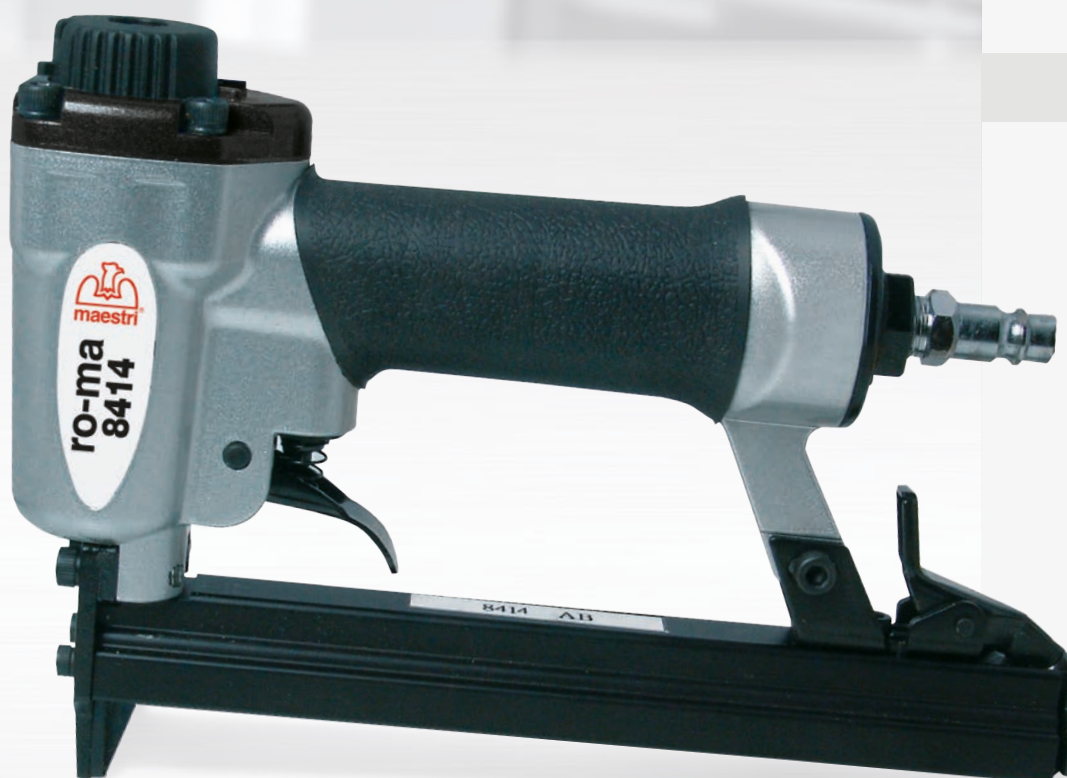

**84**

Si consiglia l'utilizzo di punti originali Maestri  
Pag. 112



130 mm



0,90



4/7

## FISSATRICI PNEUMATICHE PER PUNTI MEDI

Potente, leggera, compatta. Caricamento da sottobanchina. Per laboratori artigianali, di falegnameria, di carpenteria. Deflettore d'aria Assemblaggio telai e cornici. direzioneabile.

Impugnatura in gomma.



Caratteristiche:

Consumo d'aria  
a 60 cicli/min: 56,6 l/min  
a 6,2 bar (10psi)

Rumorosità: LpA 89,5 dBA

Vibrazioni: < 2,5 m/s<sup>2</sup>

Disponibile in:



Conforme  
alle direttive:

► 2006/42/CE



CODICE	ARTICOLO	PACK	
0153115	RO-MA 9240	92/	1



92/

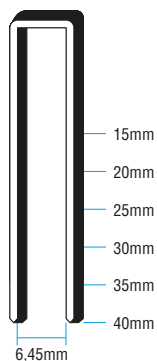

**92**

Si consiglia l'utilizzo di punti originali Maestri  
Pag. 113



150 mm



1,45



ATM

4,5/7

Potente, leggera, compatta.  
Ideale per tappezzeria  
murale. Ricopertura  
poltrone e divani.

Lavorazioni di decorazione.  
Installazione isolamenti  
termici ed acustici.  
Interni roulotte, camper

e nautica. Caricamento da  
sottobanchina.

# RO-MA 9025

CODICE	ARTICOLO	PACK	
0153155	RO-MA 9025	90/	1



Impugnatura in gomma.



Caratteristiche:

Consumo d'aria  
a 60 cicli/min: 85  $\ell$ /min  
a 6,2 bar

Rumorosità: LpA 90 dBA

Vibrazioni: 2,7  $m/s^2$

Disponibile in:



Conforme  
alle direttive:

► 2006/42/CE

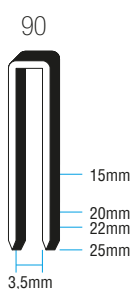

**90**

Si consiglia l'utilizzo di punti originali Maestri  
Pag. 113



140 mm



1



4/7

## FISSATRICI PNEUMATICHE PER PUNTI MEDI

*Potente, leggera, compatta.  
Allestimenti stand e  
arredamenti negozi.  
Profili su legno per*

*serramenti ed infissi.  
Perlinati interni ed esterni.  
Caricamento laterale  
(chiodini) e da sopra*

*(punti metallici).  
Deflettore d'aria  
direzionabile.*

Impugnatura in gomma.



Caratteristiche:

Consumo d'aria  
a 60 cicli/min: 67  $\ell$ /min

Rumorosità: LwA 97,1 dBA

Vibrazioni: 3,8  $m/s^2$

Disponibile in:



Conforme  
alle direttive:

► 2006/42/CE



CODICE	ARTICOLO			PACK
0153206	RO-MA 90 COMBI RED LINE	90/	AX-TG	1



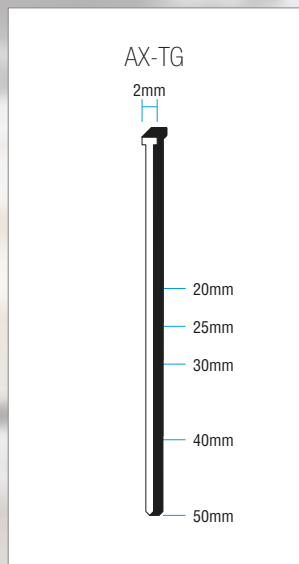
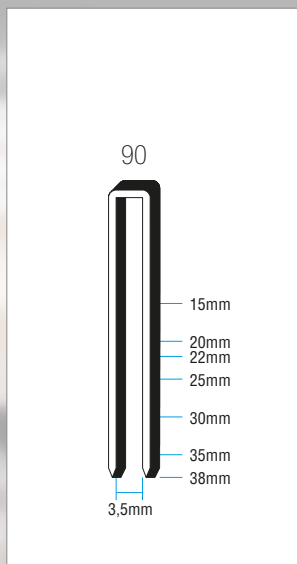

## 90 AX-TG

Si consiglia l'utilizzo di punti originali Maestri  
Pag. 113, 116

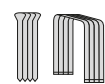

125 mm

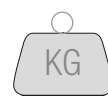

1,50



4/8

## CHIODATRICI PNEUMATICHE DI FINIZIONE

Potente, leggera, compatta.  
Ideale per perlinati interni  
ed esterni. Serramenti,  
infissi. Rivestimenti su

prefabbricati. Interni  
roulottes, campers, nautica.  
Fissaggio coprifili  
a parete.

Caricamento laterale.

Impugnatura in gomma.



Caratteristiche:

Consumo d'aria  
a 60 cicli/min: 47 l/min

Rumorosità: LwA 102,1 dBA

Vibrazioni: 3,6 m/s<sup>2</sup>

Disponibile in:



Conforme  
alle direttive:

► 2006/42/CE



CODICE	ARTICOLO	PACK	
0157302	RO-MA 30TG RED LINE	AX-TG	1



AX-TG

2mm



15mm

20mm

25mm

30mm

**AX-TG**

Si consiglia l'utilizzo di chiodini originali Maestri  
Pag. 116



125 mm



1,10



ATM

4/8



Ideale per il fissaggio di profili su legno, serramenti ed infissi. Fissaggio cornici su

mobili, coprifili a parete, perlinati interni ed esterni. Rivestimenti su prefabbricati.

Arredamento negozi, interni roulottes, camper, nautica. Carica laterale.

CODICE	ARTICOLO	PACK
0157342	RO-MA 50TG RED LINE	AX-TG 1

Impugnatura in gomma.



Caratteristiche:

Consumo d'aria a 60 cicli/min: 85 l/min

Rumorosità: LwA 101 dBA

Vibrazioni: 3,7 m/s<sup>2</sup>

Disponibile in:



Conforme alle direttive:

► 2006/42/CE



AX-TG

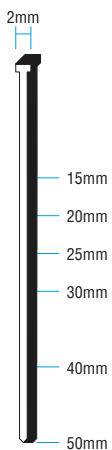

**AX-TG**

Si consiglia l'utilizzo di chiodini originali Maestri  
Pag. 116



125 mm

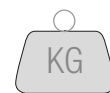

1,50



4/8

# RO-MA 50 CONCRETE

## CHIODATRICI PNEUMATICHE DI FINIZIONE

Chiodatrice che utilizza due tipologie di chiodi. Tipo concrete in acciaio temperato per fissaggio zoccoli e profili

su cemento e tipo GG in acciaio ad alta resistenza per applicazioni di battiscopa, produzione di sedie, coprifili,

cofani mortuari, mobili rustici in stile ed interni di roulotte e camper. Carica dei chiodi laterale.

Impugnatura in gomma.



Caratteristiche:

Consumo d'aria a 60 cicli/min: 80 l/min

Rumorosità: LpA 93,76 dBA  
LwA 98,96 dBA

Vibrazioni: 2,97 m/s<sup>2</sup>

Disponibile in:



Conforme alle direttive:

► 2006/42/CE



CODICE	ARTICOLO		PACK
0231230	RO-MA 50 CONCRETE	Ø 1.83	GG 1

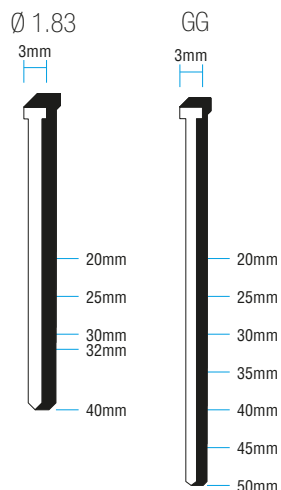

**Ø 1.83 GG**

Si consiglia l'utilizzo di chiodini originali Maestri  
Pag. 114, 115



127 mm



1,50



ATM

4,8/7,6

# RO-MA 55 MULTIBRAD

Chiodatrice che utilizza tre tipologie di chiodi. Ideale per fissaggio profili su legno per serramenti ed infissi.

Fissaggio cornici su mobili e coprifili a parete. Perlinati interni ed esterni. Rivestimenti su

prefabbricati. Arredamento negozi e allestimento stands, interni roulottes, camper e nautica.

CODICE	ARTICOLO				PACK
0231255	RO-MA 55 MULTIBRAD	AX-TG	AY-LS2	AZ-LS	1

Impugnatura in gomma.



Caratteristiche:

Consumo d'aria a 60 cicli/min: 80 l/min

Rumorosità: LpA 91,4 dBA  
LwA 96,9 dBA

Vibrazioni: 3,54 m/s<sup>2</sup>

Disponibile in:



Conforme alle direttive:

► 2006/42/CE

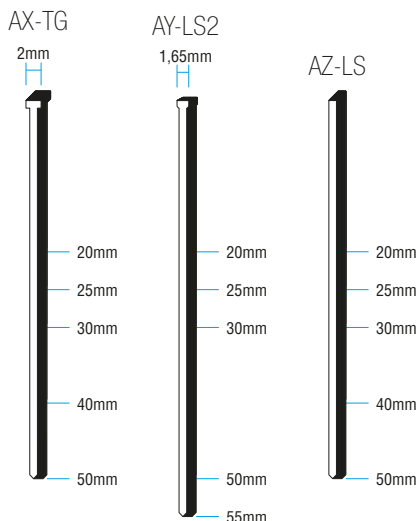

## AX-TG | AY-LS2 | AZ-LS

Si consiglia l'utilizzo di chiodini originali Maestri  
Pag. 115, 116



130 mm

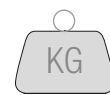

1,50



ATM

4,8/7,6

## CHIODATRICI PNEUMATICHE DI FINIZIONE

Chiodatrici pneumatiche che utilizzano micropini e microbrands 064. Ideali per il fissaggio: cornici su

mobili, coprifili a parete. Perlinati interni ed esterni. Rivestimenti su prefabbricati. Fissaggio profili su legno

per serramenti ed infissi. Arredamento negozi, interni roulottes, camper e nautica. Carica laterale.

Impugnatura in gomma.



Caratteristiche:

Consumo d'aria  
a 60 cicli/min: 56,6 l/min  
a 6,2 bar (10psi)

Rumorosità: LpA 85 dBA

Vibrazioni: 0,79 m/s<sup>2</sup>

Disponibile in:



Conforme alle direttive:

► 2006/42/CE



CODICE	ARTICOLO	PACK	
0231239	RO-MA 30/64	M064CT	M064ST 1

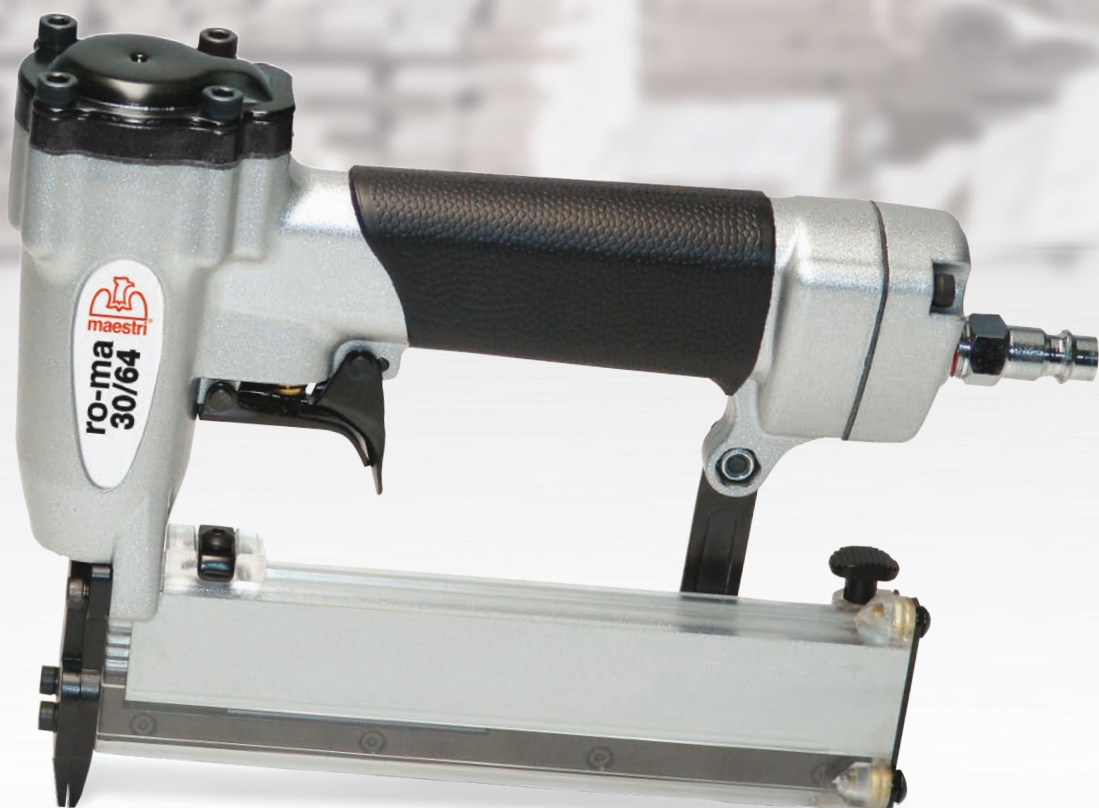

M064CT

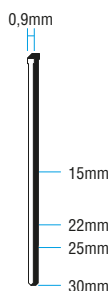

M064ST

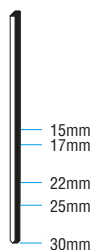

**M064CT M064ST**

Si consiglia l'utilizzo di chiodini originali Maestri  
Pag. 116



82 mm



0,94



ATM

4/6

# RO-MA 35/64

CODICE	ARTICOLO			PACK
0231241	RO-MA 35/64	M064CT	M064ST	1

Impugnatura in gomma.



Caratteristiche:

Consumo d'aria  
a 60 cicli/min: 28,3 ℓ/min  
a 6,2 bar (10psi)

Rumorosità: LpA 72 dBA  
LwA 82,9 dBA

Vibrazioni: 0,65 m/s<sup>2</sup>

Disponibile in:



Conforme  
alle direttive:

► 2006/42/CE



M064CT

0,9mm



M064ST

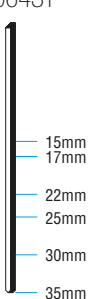

**M064CT | M064ST**

Si consiglia l'utilizzo di chiodini originali Maestri  
Pag. 116



82 mm

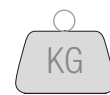

0,94



4/7

## CHIODATRICI PNEUMATICHE DI FINIZIONE

Potenti, leggere, compatte. Ideali per il fissaggio profili su legno per serramenti ed infissi,

cornici su mobili, coprifili a parete. Perlinati interni ed esterni. Rivestimenti su prefabbricati.

Arredamento negozi, interni roulottes, camper, nautica. Carica laterale.

Impugnatura in gomma.



Caratteristiche:

Consumo d'aria a 60 cicli/min: 43,3 l/min a 6,2 bar (10psi)

Rumorosità: LpA 88 dBA

Vibrazioni: 3,2 m/s<sup>2</sup>

Disponibile in:



Conforme alle direttive:

► 2006/42/CE



CODICE	ARTICOLO	PACK	
0231246	RO-MA 30/08	AP08	1



AP08

1,3mm



15mm  
20mm  
25mm  
30mm

**AP<sup>®</sup> 08**

Si consiglia l'utilizzo di chiodini originali Maestri  
Pag. 115



170 mm



1



4/7

CODICE	ARTICOLO	PACK
0231237	RO-MA 45/08	AP08 1

Impugnatura in gomma.

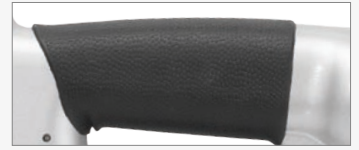

Caratteristiche:

Consumo d'aria  
a 60 cicli/min: 20,5 ℓ/min  
a 6,2 bar (10psi)

Rumorosità: LpA 87,54 dBA  
LwA 93,25 dBA

Vibrazioni: 1,85 m/s<sup>2</sup>

Disponibile in:



Conforme  
alle direttive:

► 2006/42/CE



AP08

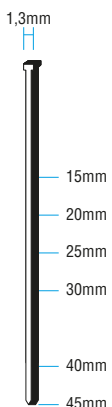

**AP<sup>®</sup> 08**

Si consiglia l'utilizzo di chiodini originali Maestri  
Pag. 115



142 mm



1,10



4,1/6,9

Apparecchio pneumatico per una veloce e precisa infissione di borchie decorative nastrate,

semplice da caricare e pratico da usare. Fusione in lega speciale di alluminio.

Pratico sistema pneumatico di avanzamento borchie utilizzato nei mobilifici, mobili e poltrone in stile,

Caricatore in nylon 30% fibre di vetro.



**Caratteristiche:**

Consumo d'aria a 60 cicli/min: 18 l/min a 6,2 bar (10psi)

Rumorosità: LpA 80,2 dBA LwA 92,6 dBA

Vibrazioni: 2,9 m/s<sup>2</sup>

Disponibile in:



Conforme alle direttive:

► 2006/42/CE



CODICE	ARTICOLO				PACK
0290108	B6 PN/2	6/GL	6/AN	7S/AN	1
0290120	B10 PN/2	10/GL	10/AN		1
0290125	B11 PN/2	11/GL			1

MADE in ITALY

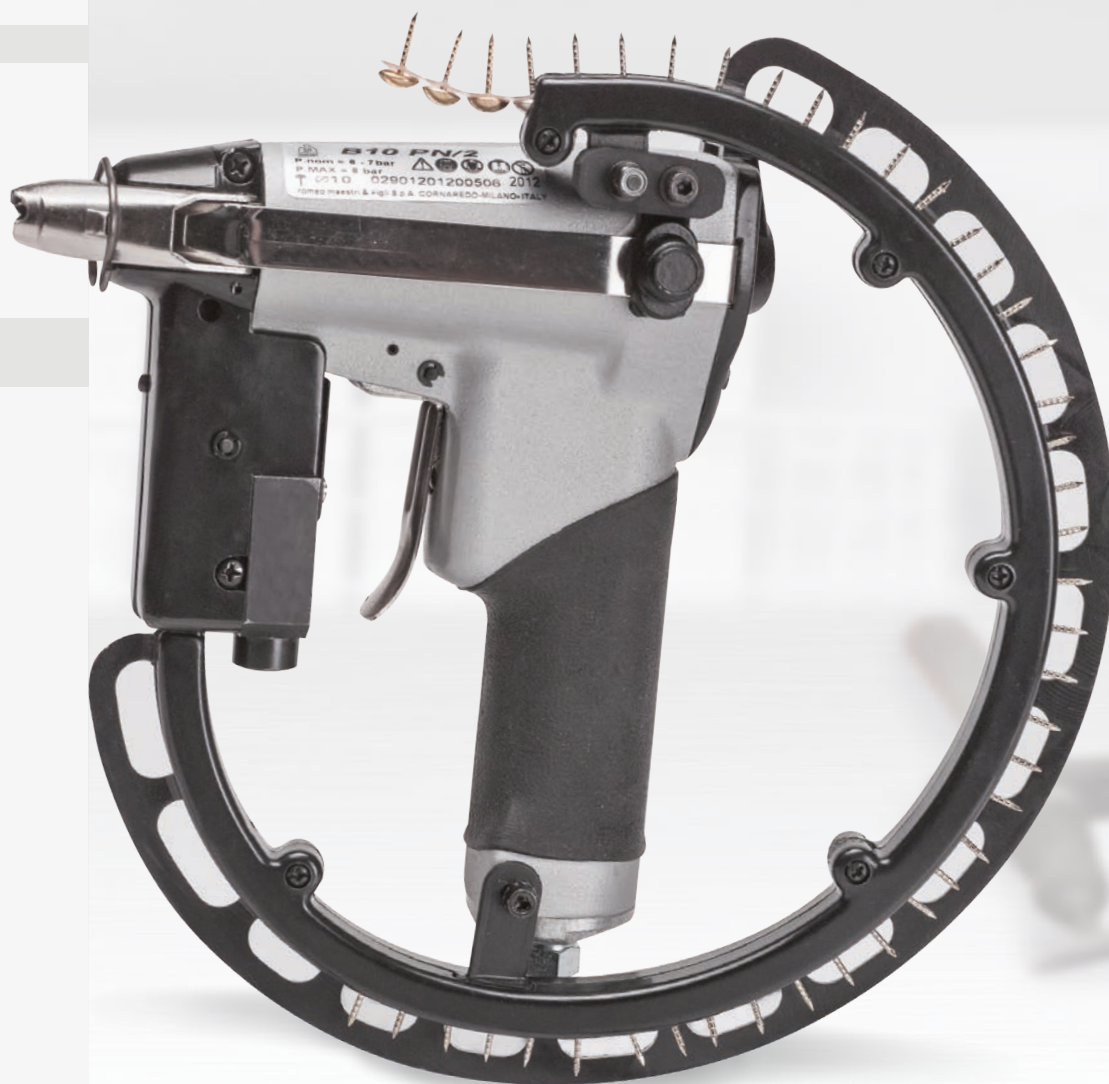

**6/GL-AN | 7S/AN | 10/GL-AN | 11/GL**

Si consiglia l'utilizzo di borchie originali Maestri  
Pag. 117, 118



nei calzaturifici, zoccolifici,  
per lavori di decorazione  
(come la borchatura  
di cofani e bauli etc.).

Disponibile in 3 modelli.

### Mod. B6 PN/2

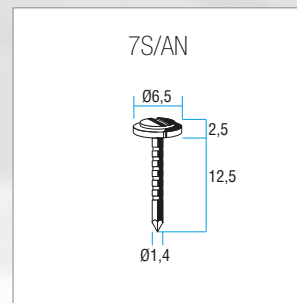
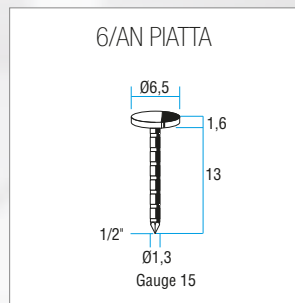
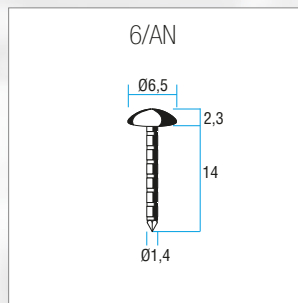
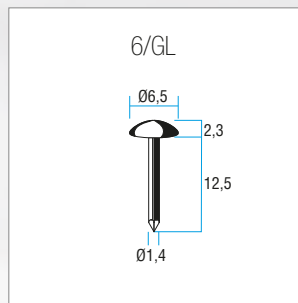

⊕ Disponibili anche con  
impronta SCR

### Mod. B10 PN/2

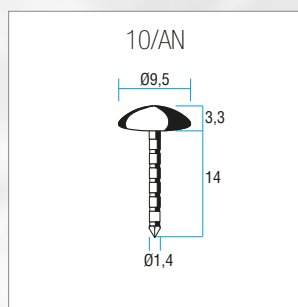
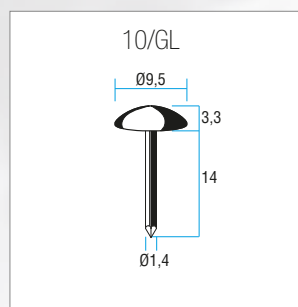

### Mod. B11 PN/2

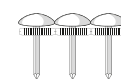
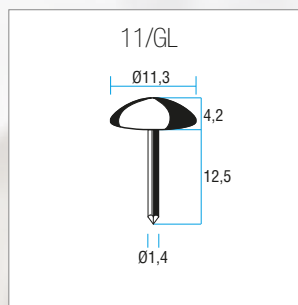

45/75

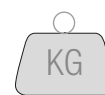

1



6/8

F12	66
FP12	67
F18	68
FP18	69
F15 FLEX	70
FP15 FLEX	71





## CHIODATRICI PER CORNICI MANUALE

*Per tutti i tipi di applicazione  
di cornici e vetrinistica.  
Fissaggio permanente.*

Regolatore di potenza.



Stabilizzatore.



Caratteristiche:

Rumorosità: LpA 80,4 dBA  
LwA 88,8 dBA

Vibrazioni: 1,1 m/s<sup>2</sup>

Disponibile in:



CODICE	ARTICOLO	PACK
0123001	F12	Brads F12 <b>E</b> 4

MADE in ITALY



BRADS F

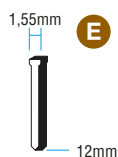

### BRADS F12

Si consiglia l'utilizzo di chiodini originali Maestri  
Pag. 118



68 mm



KG

0,65

PNEUMATICA

Per uso intensivo.



# FP12

CODICE	ARTICOLO	PACK
0123302	FP12	Brads F12 <b>E</b> 1

 MADE in ITALY



Regolatore di potenza.



Stabilizzatore.



Collettore stendibile per aria compressa.



Caratteristiche:

Consumo d'aria a 60 cicli/min: 14 l/min

Disponibile in:



Conforme alle direttive:

► 2006/42/CE



BRADS F

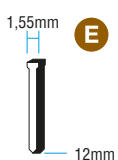

## BRADS F12

Si consiglia l'utilizzo di chiodini originali Maestri  
Pag. 118



68 mm



0,85



4/6

## CHIODATRICI PER CORNICI MANUALE

Per tutti i tipi di applicazione  
di cornici.  
Fissaggio permanente.

Regolatore di potenza.

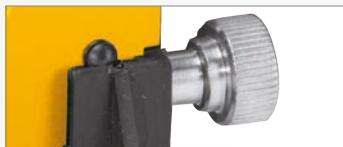

Stabilizzatore.



Caratteristiche:

Rumorosità: LpA 80,4 dBA  
LwA 88,8 dBA

Vibrazioni: 1,1 m/s<sup>2</sup>

Disponibile in:



CODICE	ARTICOLO	PACK
0123010	F18	Brads F18 <b>E</b> 4

MADE in ITALY



BRADS F

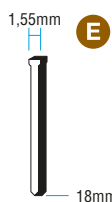

### BRADS F18

Si consiglia l'utilizzo di chiodini originali Maestri  
Pag. 118



68 mm

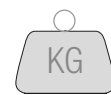

0,65

PNEUMATICA

Per uso intensivo.



# FP18

CODICE	ARTICOLO	PACK
0123311	FP18	Brads F18 <b>E</b> 1

MADE in ITALY



2.000 BRADS F18 ►  
INCLUSI

Regolatore di potenza.

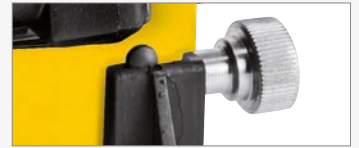

Stabilizzatore.



Collettore stendibile per aria compressa.



Caratteristiche:

Consumo d'aria a 60 cicli/min: 14 l/min

Disponibile in:



Conforme alle direttive:

► 2006/42/CE  
**CE UK CA**

BRADS F

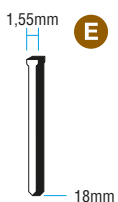

## BRADS F18

Si consiglia l'utilizzo di chiodini originali Maestri  
Pag. 118



68 mm

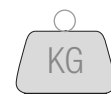

0,85



4/6

## CHIODATRICI PER CORNICI MANUALE

*Per lamelle flessibili  
ripiegabili più volte senza  
danno per foto e dipinti.*

Regolatore di potenza.

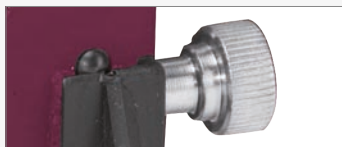

Stabilizzatore.



Caratteristiche:

Rumorosità: LpA 80,4 dBA  
LwA 88,8 dBA

Vibrazioni: 1,1 m/s<sup>2</sup>

Disponibile in:



CODICE	ARTICOLO	PACK
0123133	F15 FLEX	Romaflex 15 <b>G</b> 4

MADE in ITALY



ROMAFLEX 15 **G**

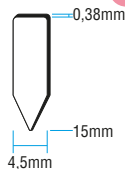

### ROMAFLEX 15

Si consiglia l'utilizzo di lamelle originali Maestri  
Pag. 118

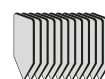

68 mm



0,65



PNEUMATICA

Per uso intensivo.



# FP15 FLEX

CODICE	ARTICOLO	PACK
0123313	FP15 FLEX	Romaflex 15 <b>G</b> 1

MADE in ITALY



Regolatore di potenza.



Stabilizzatore.



Collettore stendibile per aria compressa.



Caratteristiche:

Consumo d'aria a 60 cicli/min: 14 l/min

Disponibile in:



Conforme alle direttive:

► 2006/42/CE



ROMAFLEX 15 **G**

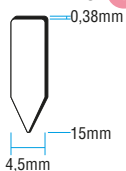

## ROMAFLEX 15

Si consiglia l'utilizzo di lamelle originali Maestri  
Pag. 118

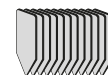

68 mm

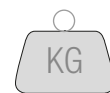

0,85



4/6

ROAMA MANUAL	74
ROAMA PNEUMATIC	75
ELPABOX BH	76
ELPABOX BA	77
RI-19/A	78
RO-MA 73	79
GF135 MECCANICA	80
GF135 PNEUMATICA	81



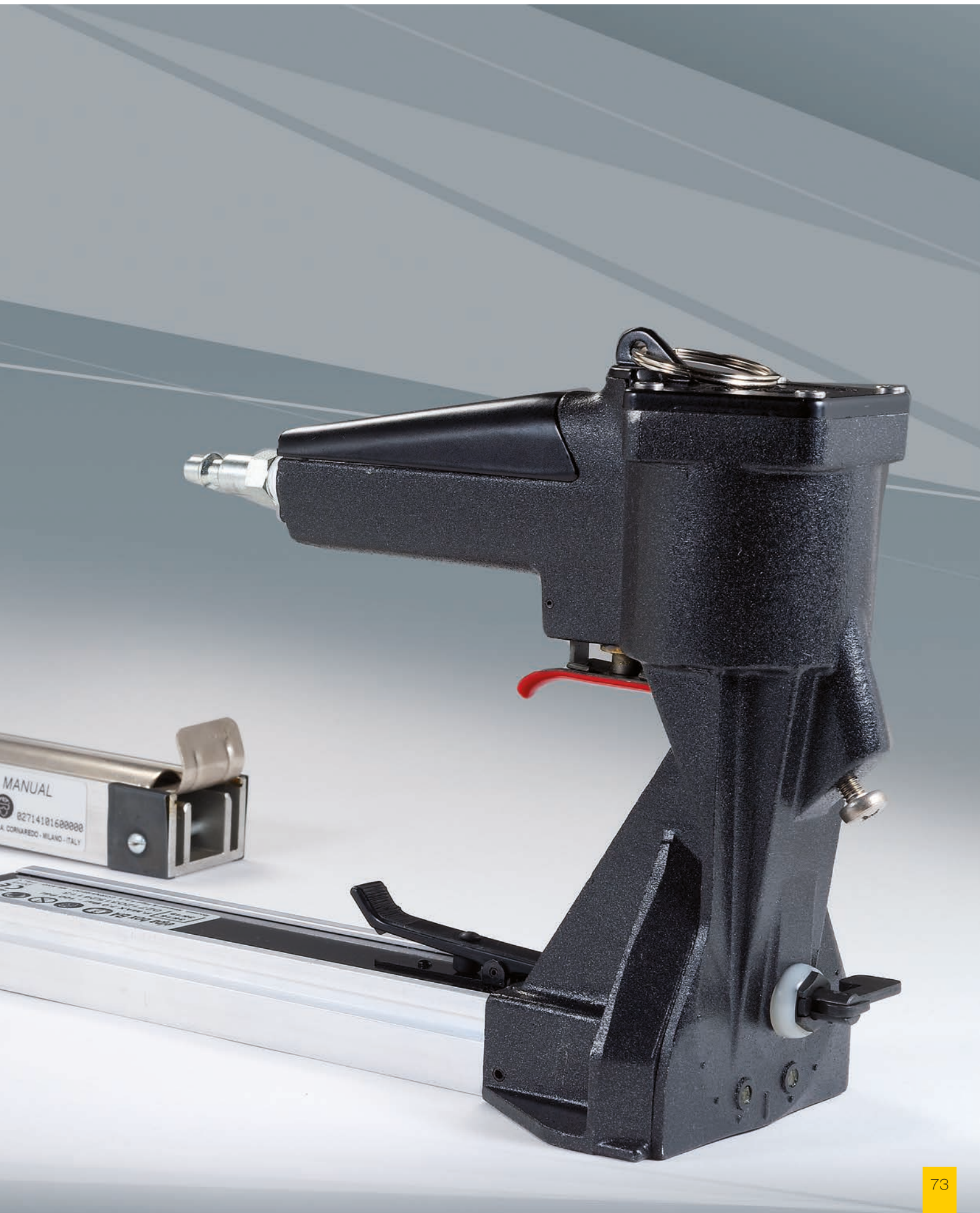

# ROAMA MANUAL

## AGGRAFFATRICI MANUALI

Aggraffatrice manuale per la chiusura di scatole in cartone ondulato. Studiata per garantire con un minimo

sforzo elevate prestazioni in fase di chiusura dei cartoni. Nella zona anteriore del corpo è presente

una maniglia che rende l'attrezzo più maneggevole anche in caso di lavori intensivi.

Corpo macchina pressofuso in lega di alluminio molto resistente.



Pratica impugnatura.



Disponibile in:



MADE in ITALY

CODICE	ARTICOLO	PACK	
0271401	ROAMA 35/15	35/	1
0271405	ROAMA 35/19	35/	1
0271410	ROAMA 35/22	35/	1

Disponibile in 3 modelli.

Mod. 35/15

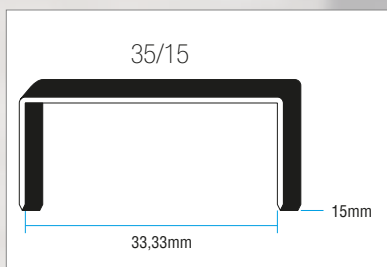

Mod. 35/19

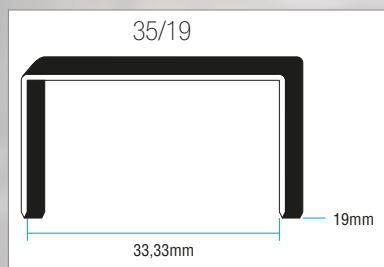

Mod. 35/22

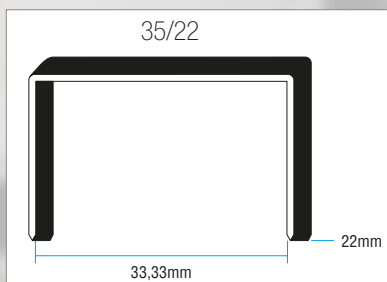

**35**

Si consiglia l'utilizzo di punti originali Maestri  
Pag. 119



210 mm



KG

2,16

# AGGRAFFATRICI PNEUMATICHE



## ROAMA PNEUMATIC

Aggraffatrice pneumatica  
per la chiusura di scatole  
in cartone ondulato,  
studiata per garantire

elevate prestazioni  
in fase di chiusura  
dei cartoni.

CODICE	ARTICOLO	35/	PACK
0271501	ROAMA 35/15	35/	1
0271505	ROAMA 35/19	35/	1
0271510	ROAMA 35/22	35/	1

Disponibile in 3 modelli.

Mod. 35/15

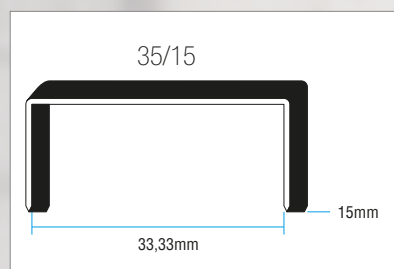

Mod. 35/19

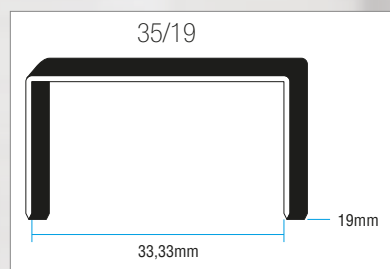

Mod. 35/22

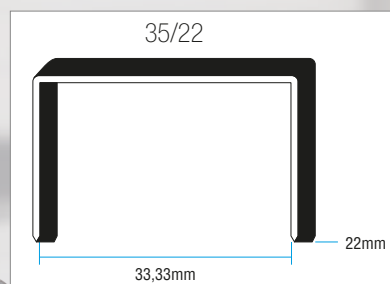

Corpo macchina pressofuso  
in lega di alluminio molto  
resistente.



Pratico gancio.



Caratteristiche:

Consumo d'aria  
a 60 cicli/min: 84 l/min

Rumorosità: LpA 80,9 dBA  
LwA 94 dBA

Vibrazioni: 2,81 m/s<sup>2</sup>

Disponibile in:



Conforme alle direttive:

► 2006/42/CE



MADE in ITALY



**35**

Si consiglia l'utilizzo di punti originali Maestri  
Pag. 119



210 mm



2,60



6

Aggraffatrice leggera e maneggevole. Indicata per la chiusura dei coperchi, fondi di scatole e cartone ondulato.

Corpo in lega speciale di alluminio. L'impugnatura anteriore garantisce maggiore stabilità e velocità di cucitura.

Dotata di regolazione della profondità di cucitura e forma del punto. Due altezze di punti metallici nella stessa macchina.

Regolatore di profondità.



Pratica impugnatura.



Disponibile in:



CODICE	ARTICOLO	PACK	
0271103	ELPABOX BH-35	35/	1

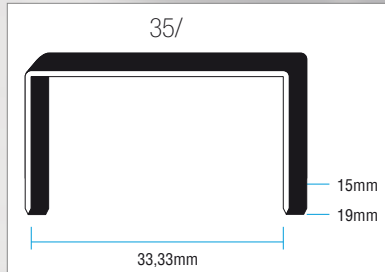

MADE in ITALY



35/15

35/19

**35**

Si consiglia l'utilizzo di punti originali Maestri  
Pag. 119



200 mm



1,30

# AGGRAFFATRICI PNEUMATICHE



Aggraffatrice pneumatica compatta e leggera, studiata per garantire elevate prestazioni in fase

di chiusura dei cartoni. Dotata di un'ampia superficie di appoggio che evita fastidiosi spostamenti

in fase di cucitura. Regolazione della profondità di chiusura e conformazione del punto.

## ELPABOX BA

CODICE	ARTICOLO	PACK
0271203	ELPABOX BA-35	35/ 1

 MADE in ITALY

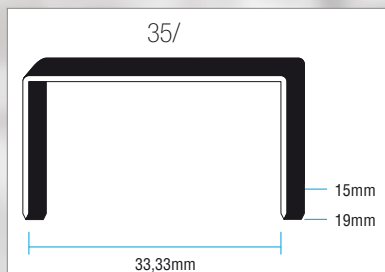

Regolatore di profondità.



Corpo macchina pressofuso in lega di alluminio molto resistente.



Caratteristiche:

Consumo d'aria a 30 cicli/min: 33 l/min  
 Rumorosità: LpA 78,5 dBA  
 LwA 91,5 dBA  
 Vibrazioni: 2,41 m/s<sup>2</sup>

Disponibile in:



Conforme alle direttive:

► 2006/42/CE



35/15

35/19

**35**

Si consiglia l'utilizzo di punti originali Maestri  
 Pag. 119



200 mm



1,60



ATM

5/7

Aggraffatrice compatta e leggera dotata di un' ampia superficie di appoggio

che evita fastidiosi spostamenti in fase di aggraffatura. Adatta alla chiusura

in serie di scatole di cartone ondulato. Regolazione della profondità di chiusura e conformazione del punto.

Corpo macchina pressofuso in lega di alluminio molto resistente.



### Caratteristiche:

Consumo d'aria a 60 cicli/min: 67 l/min

Rumorosità: LpA 89 dBA  
LwA 95 dBA

Vibrazioni: 3,8 m/s<sup>2</sup>

### Conforme alle direttive:

► 2006/42/CE



CODICE	ARTICOLO	PACK
0271230	RI-19/A	M15/A - M19/A 1



M15/A - M19/A

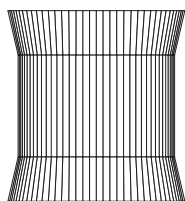

### M15/A M19/A

Si consiglia l'utilizzo di punti originali Maestri  
Pag. 120



1000



2,40



5/7



Cucitrice con accessori particolarmente adatta alla chiusura di spessori medio alti, (sacchetti,

cartoncini, buste imbottite, scatole di cartone ondulato etc.). Molto robusta, con fermo di sicurezza per

la mano. Caricamento tradizionale da dietro. Capacità di chiusura: circa 6 mm.

## RO-MA 73

CODICE	ARTICOLO	PACK	
0040120	RO-MA 73	73/	5
0099205	RO-MA 73 KIT (73/8 - 73/10 - 73/12) - 15.000	73/	1

Fermo di sicurezza.



Base a baionetta per la chiusura dei lembi delle scatole in cartone.



Base arrotondata per la chiusura dei sacchetti in cellophane e polietilene.



Disponibile in:

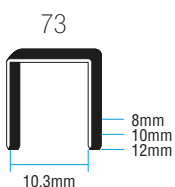

**73**

Si consiglia l'utilizzo di punti originali Maestri  
Pag. 119



93 mm

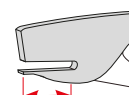

68 mm

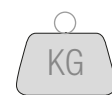

0,46

## GF135 MECCANICA

Aggraffatrici progettate per la chiusura dei fondi di scatole in cartone ondulato.

Pedale meccanico.

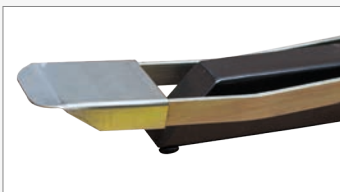

Dispositivo di sicurezza.



CODICE	ARTICOLO	PACK	
0271705	GF135 MECCANICA	35/	1

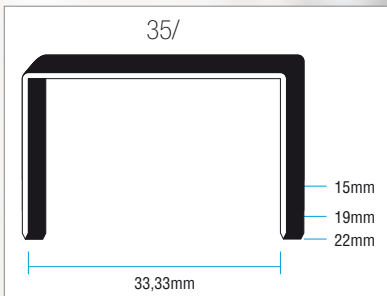

MADE in ITALY



**35**

Si consiglia l'utilizzo di punti originali Maestri  
Pag. 119



380 mm



35

Per uso intensivo.

## GF135 PNEUMATICA

CODICE	ARTICOLO	35/	PACK
0271725	GF135 PNEUMATICA	35/	1

 MADE in ITALY

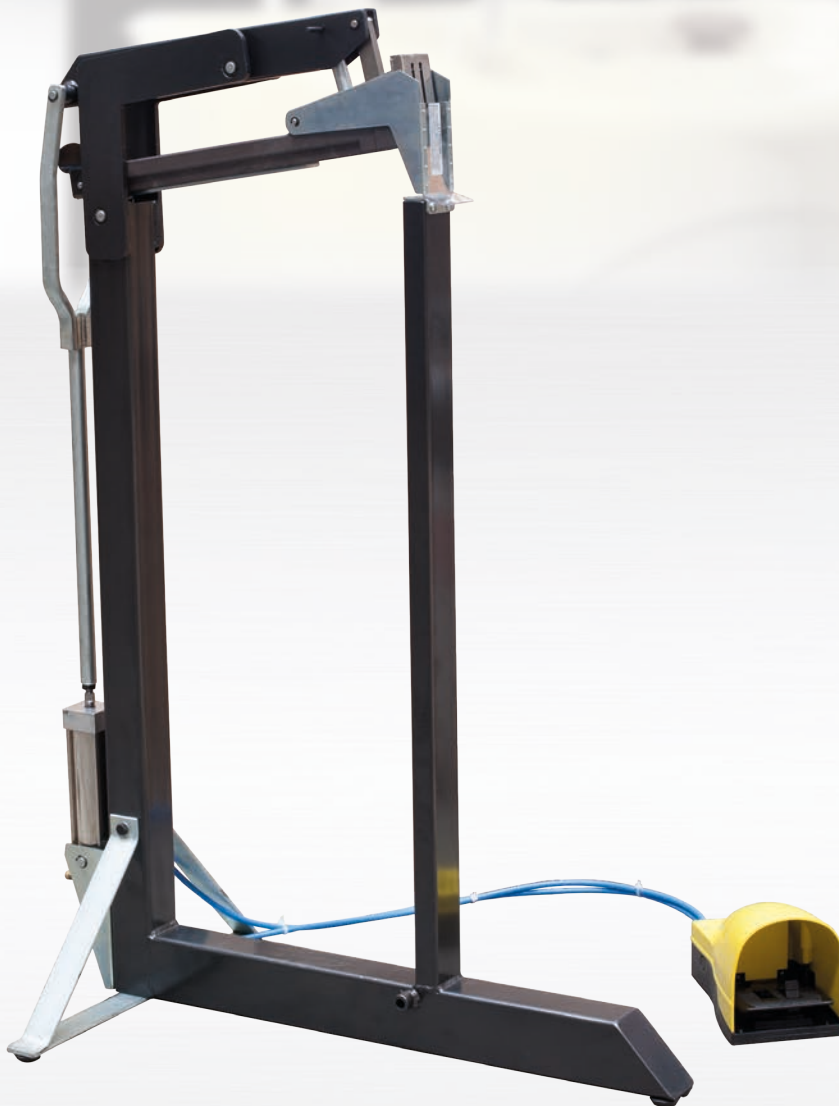
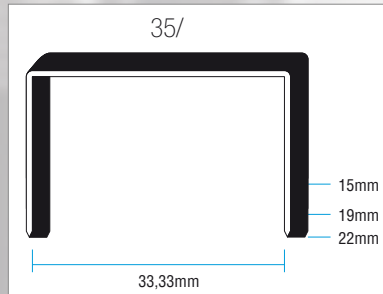

Pedale a comando pneumatico.



Dispositivo di sicurezza.



Caratteristiche:

Consumo d'aria  
a 60 cicli/min: 170 l/min

Rumorosità: LpA <80 dBA

Vibrazioni: <2,5 m/s<sup>2</sup>

Conforme alle direttive:

► 2006/42/CE



**35**

Si consiglia l'utilizzo di punti originali Maestri  
Pag. 119



380 mm



35



5/7

MULTENS	84
B051	86
320 - M13-32	87
BAND-IT C001	88
FA/PLAST - MPL	90
TB 1216	92
TB 1620	93
M4000 - PR/P	94
EASY PACK	95





## TENDIREGGIA MANUALI REGGIATURA IN METALLO

Utilizzato per reggiare colli di vario tipo, dimensione e materiale (plastica, legno etc.)

con reggia metallica e relativi sigilli in acciaio. Effettua operazione di reggiatura e taglio reggia.

Robusto, maneggevole, facile da usare.

Punzone regolabile per le misure 13-16mm/18-20mm.



Disponibile in:



CODICE	ARTICOLO	PACK
0173310	<b>MULTENS FB4</b>	1
0173312	<b>MULTENS FB320</b>	1

MADE in ITALY



Mod. FB4 punzone regolabile

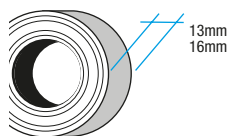

Pag. 121

Mod. FB320 punzone regolabile

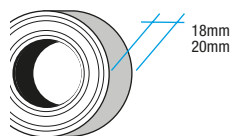

Pag. 121



3,90

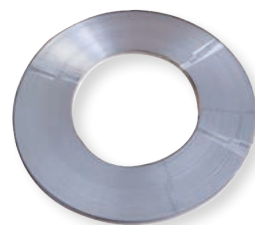

**SIGILLI ACCIAIO NEUTRI E  
CON DICITURA (esecuzioni per 50.000pz.)**

**REGGIA METALLICA CON BORDI ARROTONDATI**  
ø interno 300 mm - ø esterno 550 mm

spessore 0,3 mm

spessore 0,5 - 0,6 - 1 mm

**313**

**316**

**320**

**13**

**16**

**18**

**20**

**MULTENS  
FB4**

•

•

•

•

**MULTENS  
FB320**

•

•

•

## TENDIREGGIA MANUALI REGGIATURA IN METALLO

*Tendireggia universale  
per reggia in acciaio.  
Ideale per reggiature  
verticali ed orizzontali.*

Sistema di chiusura ad  
incastro e taglio reggetta.



CODICE	ARTICOLO	PACK
0292120	B051	1

### SENZA SIGILLO



Mod. B051

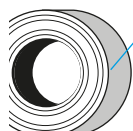

13mm  
16mm  
18mm  
19mm  
20mm  
spessore  
0,60mm

Pag. 121



KG

4,25



# PORTAREGGIA REGGIATURA IN METALLO

Portareggia per regge  
in metallo. Bobina Ø  
esterno da 500 a 600 mm.



## 320 - M13-32

CODICE	ARTICOLO	PACK
0191121	<b>320</b>	1
0191133	<b>M13-32</b>	1

 MADE in ITALY

Dotati di ruote per agevolare  
gli spostamenti.

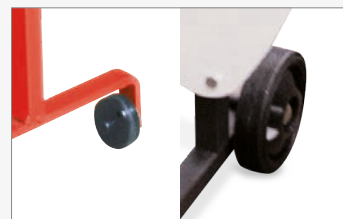

Mod. 320

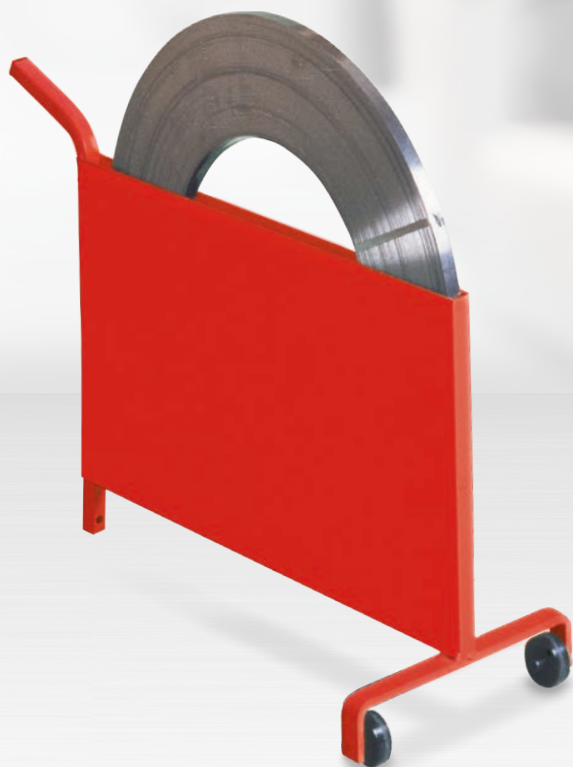

Mod. M13-32



Mod. 320

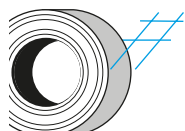

10mm  
20mm

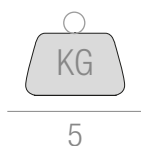

Pag. 121

Mod. M13-32

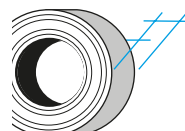

13mm  
32mm

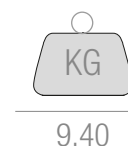

Pag. 121

## TENDIREGGIA MANUALI REGGIATURA IN METALLO

*Utensile in acciaio per  
tensionamento fasce inox.*

# BAND-IT C001

Corpo macchina robusto.



Disponibile in:



CODICE	ARTICOLO	PACK
0173601	C001 BAND-IT	1





Nastro Band-It

CODICE	ARTICOLO	MATERIALE	MT	PACK	Carico Rottura Kg/mm <sup>2</sup>
1180001	<b>C202</b> 6,4x0,51 mm - 1/4"	INOX	30	1	225
1180003	<b>C203</b> 9,5x0,64 mm - 3/8"	INOX	30	1	400
1180005	<b>C204</b> 12,7x0,76 mm - 1/2"	INOX	30	1	680
1180007	<b>C205</b> 15,9x0,76 mm - 5/8"	INOX	30	1	890
1180009	<b>C206</b> 19,1x0,76 mm - 3/4"	INOX	30	1	1090



Graffe Band-It

CODICE	ARTICOLO	MATERIALE	PCS	PACK
1181001	<b>C252</b> 6,4 mm - 1/4"	INOX	100	1
1181003	<b>C253</b> 9,5 mm - 3/8"	INOX	100	1
1181005	<b>C254</b> 12,7 mm - 1/2"	INOX	100	1
1181007	<b>C255</b> 15,9 mm - 5/8"	INOX	100	1
1181009	<b>C256</b> 19,1 mm - 3/4"	INOX	100	1

## TENDIREGGIA MANUALI REGGIATURA IN PLASTICA

*Tenditori manuali  
a trazione diretta  
per regge in polipropilene.  
Leve di azionamento in*

*lamiera stampata dotate  
di comode manopole  
antiscivolo, base di  
appoggio in alluminio*

*pressofuso colore rosso,  
robusta e molto ampia.  
Adatti alla chiusura  
di scatole di cartone*

Versione con staffa ideale  
per reggiature verticali.

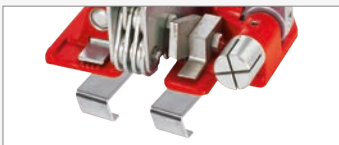

Disponibile in:

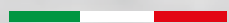

CODICE	ARTICOLO	PACK
0173111	FA/PLAST 13-16	1
0173113	MPL 13	1
0173114	MPL 16	1
0173106	MPL 13 C/ STAFFA	1
0173109	MPL 16 C/ STAFFA	1

 MADE in ITALY



Mod. FA/PLAST 13-16

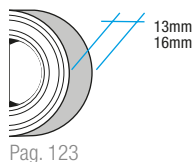

Mod. MPL13

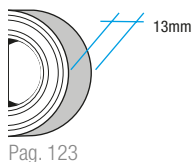

Mod. MPL16

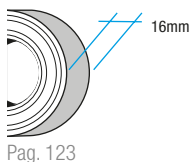

  
KG  
2,60

ondulato e di imballaggi  
di vario tipo e dimensione,  
garantiscono con un  
minimo sforzo sulle leve una

chiusura ermetica del sigillo  
di tipo aperto.

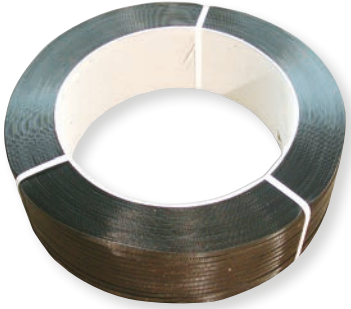

				
	<b>SIGILLI IN ACCIAIO BULINATI E CON DICITURA</b> (esecuzioni per 50.000pz) spessore 0,4 mm (LA) - 0,5 mm (PA)		<b>REGGIA PP ALTA RESISTENZA</b> bobina ø interno 60 mm - ø interno 400 mm spessore 0,5 - 0,6 - 0,8 mm	
	<b>13</b>	<b>16</b>	<b>12</b>	<b>15</b>
<b>FA/PLAST 13-16</b>	•	•	•	•
<b>MPL 13</b>	•		•	
<b>MPL 16</b>		•		•

## TENDIREGGIA A BATTERIA REGGIATURA IN PLASTICA

Tendireggia a batteria tra i più leggeri della sua categoria, utilizza reggia in polipropilene (PP) e

poliestere (PET) da 12-15 mm senza l'impiego del sigillo. Utilizzabile con una sola mano.

Tensione massima 250KG (2500N) tensionamento standard.

Pratica impugnatura.



Tasto di rilascio batteria.



Tasto di tensione **A**  
Leva di saldatura **B**



Disponibile in:



Conforme alle direttive:

- ▶ ROHS
- ▶ Batteria al litio rispetta le norme UN 38.3 in relazione alle norme di sicurezza
- ▶ 2006/42/CE



CODICE	ARTICOLO	PACK
0292146	TB 1216	1

### SENZA SIGILLO



INCLUSO DI CARICA BATTERIA ▶  
E BATTERIA AL LITIO

Mod. TB 1216

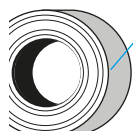

12mm  
16mm

spessore  
0,65-1,00mm

Pag. 123



BATTERIA AL LITIO  
18V 400mAh



3,50  
BATTERIA  
INCLUSA

# TB 1620

Tendireggia a batteria tra i più leggeri della sua categoria, utilizza reggia in polipropilene (PP) e

poliestere (PET) da 15-19 mm senza l'impiego del sigillo. Utilizzabile con una sola mano.

Tensione massima 400KG (4000N) alto tensionamento.

CODICE	ARTICOLO	PACK
0292147	TB 1620	1

## SENZA SIGILLO



INCLUSO DI CARICA BATTERIA ►  
E BATTERIA AL LITIO

Pratica impugnatura.



Tasto di rilascio batteria.



Tasto di tensione **A**  
Leva di saldatura **B**



Disponibile in:



Conforme alle direttive:

- ROHS
- Batteria al litio rispetta le norme UN 38.3 in relazione alle norme di sicurezza
- 2006/42/CE

CE UK CA

Mod. TB 1620

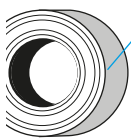

15mm  
19mm

spessore  
0,70-1,27mm

Pag. 123



BATTERIA AL LITIO  
18V 400mAh



3,50  
BATTERIA  
INCLUSA

# PORTAREGGIA REGGIATURA IN PLASTICA

Portareggia per bobine di  
reggia in polipropilene.  
Caricamento frontale.

**M4000:** grandi bobine  
Ø interno 395/400 mm

**PR/P:** piccole bobine  
Ø interno 60/62 mm

## M4000 - PR/P

### M4000

Pratico vano portautensili.



### PR/P

Gancio di sostegno.

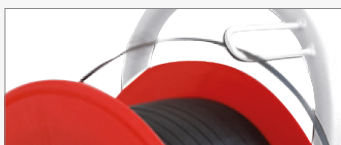

CODICE	ARTICOLO	PACK
0191103	M4000	1
0191101	PR/P	1

MADE in ITALY



Mod. M4000

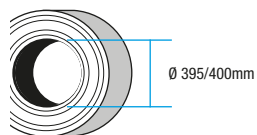

Pag. 123

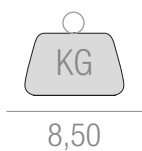

Mod. PR/P

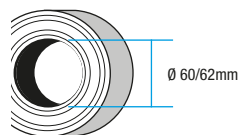

Pag. 123

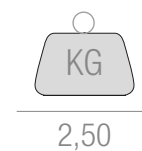



# KIT IMBALLAGGIO



*Di facile utilizzo, ideale per cartoni, casse, tubi, documenti e archivi, libri, ecc.*

## EASY PACK

CODICE	ARTICOLO	PACK
0199994	KIT EASY PACK	1

600 mt di reggia PP.



200 sigilli in plastica.



1 taglierino.



Disponibile in:

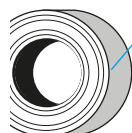
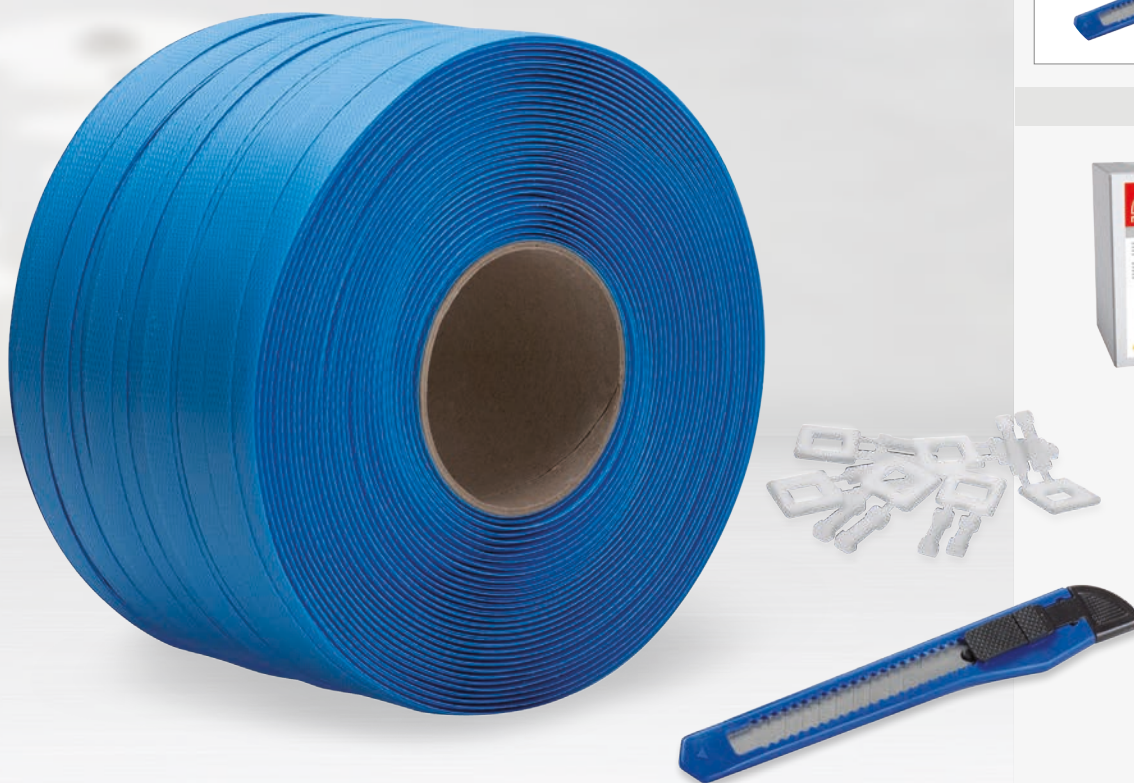

12mm

Pag. 123

spessore  
0,45mm



2,80

MINIGRIP 7H	98
GRIP 11H	99
GRIP 15HL	100
GRIP 18HP	101
GRIP 20XP	102
M 195	103
M 220	104
M 3350	105
M 812	106
M812 MG	107
M12/M7/H12/L12	108





# MINIGRIP 7H

## HOBBY

Ugello antigoccia con protezione in silicone.



Potenza 10W.

Cavalletto d'appoggio.



Disponibile in:



Conforme alle direttive:

- ▶ ROHS
- ▶ 2006/42/CE



## INCOLLATRICI

*Incollatrice elettrica per adesivi termofusibili di linea nuova, leggera e maneggevole per il*

*"fai da te", particolarmente adatta per piccole riparazioni, fissaggio di componenti in ceramica,*

*vetro e legno. Per colle standard Ø 7mm.*

CODICE	ARTICOLO	PACK
0195122	MINIGRIP 7H	12

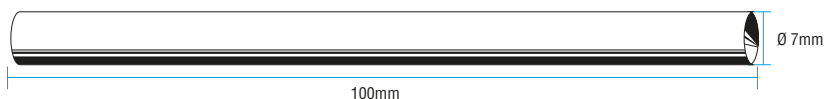

Colore colla disponibile:  
● Trasparente

**M7**

Si consiglia l'utilizzo di colle originali Maestri  
Pag. 109

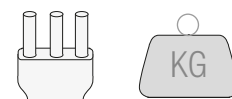

AC220/240V 50-60 Hz 0,17

Incollatrice elettrica per adesivi termofusibili di linea nuova, leggera e maneggevole per il

"fai da te", adatta per montaggi e riparazioni su legno, plastica, cartone, gomma e cuoio, posa e

riparazione di piastrelle e porcellane. Per colle standard Ø 12mm.

# GRIP 11H

## HOBBY

Ugello antigoccia con protezione in silicone.

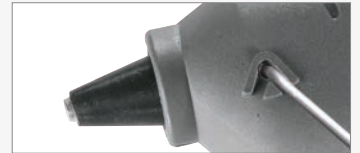

Potenza 30W.

Massima estrusione colla/ora: 360g/h.

Cavalletto d'appoggio.



Disponibile in:



Conforme alle direttive:

- ROHS
- 2006/42/CE

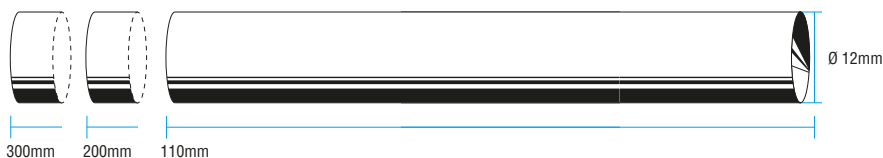

Colori colle disponibili:

- Trasparente
- Bianco
- Miele
- Rosso
- Nero
- Grigio

**M12 | H12**

Si consiglia l'utilizzo di colle originali Maestri  
Pag. 109

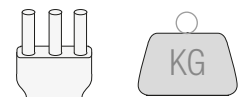

AC220/240V 50-60 Hz 0,25

## INCOLLATRICI

Incollatrici elettriche per adesivi termofusibili di linea nuova, leggere e maneggevoli per il

"fai da te", adatte per montaggi e riparazioni su legno, plastica, cartone, gomma e cuoio, posa e

riparazione di piastrelle e porcellane. Per colle standard Ø 12mm.

### HOBBY

Ugello isolato antigoccia, svitabile, intercambiabile.



Potenza 40W.

Massima estrusione colla/ora: 530g/h.

Cavalletto d'appoggio.

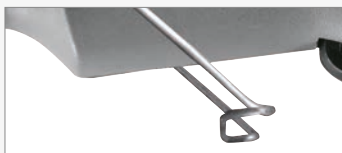

Disponibile in:



Conforme alle direttive:

- ▶ ROHS
- ▶ 2006/42/CE



CODICE	ARTICOLO	PACK
0195136	GRIP 15HL	10

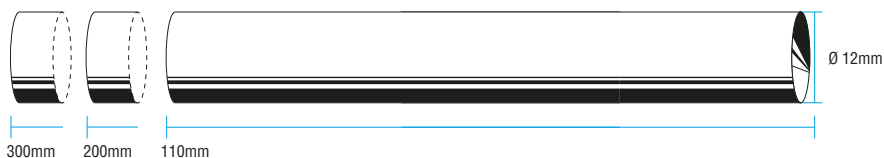

Colori colle disponibili:

- Trasparente
- Bianco
- Miele
- Rosso
- Nero
- Grigio

**M12 | H12**

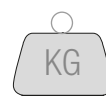

Si consiglia l'utilizzo di colle originali Maestri  
Pag. 109

AC220/240V  
50-60 Hz

0,30

# GRIP 18HP

CODICE	ARTICOLO	PACK
0195137	GRIP 18HP	6

## HOBBY

Ugello isolato antigoccia, svitabile, intercambiabile.



Potenza 60W.

Massima estrusione colla/ora: 550g/h.

Cavalletto d'appoggio.

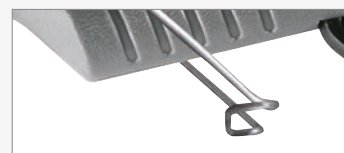

Disponibile in:



Conforme alle direttive:

- ▶ ROHS
- ▶ 2006/42/CE

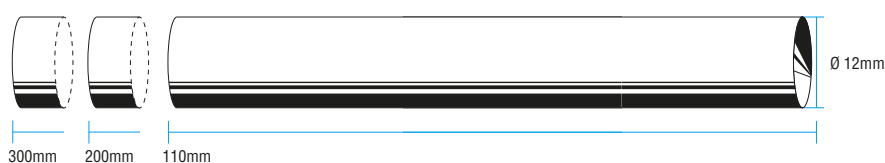

Colori colle disponibili:

- Trasparente
- Bianco
- Miele
- Rosso
- Nero
- Grigio

**M12 | H12**

Si consiglia l'utilizzo di colle originali Maestri  
Pag. 109

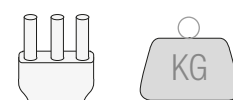

AC220/240V  
50-60 Hz

0,31

## INCOLLATRICI

*Incollatrice elettrica per adesivi termofusibili di linea nuova, leggera e maneggevole per il "fai da te", particolarmente adatta per montaggi e*

*riparazioni su legno, plastica, cartone, gomma e cuoio, posa e riparazione di piastrelle e porcellane. Dotata di termostato di sicurezza che*

*prevede lo spegnimento dell'incollatrice se lasciata più di 15 minuti ferma e di led di messa in tensione. Per colle standard Ø 12 mm.*

### HOBBY

Ugello antigoccia svitabile, intercambiabile.



Potenza 80W.

Massima estrusione colla/ora: 1 kg/h.

Cavalletto d'appoggio.



Disponibile in:



inclusi:

- ▶ 1 ugello a spatola
- ▶ 1 ugello a filo fine
- ▶ 6 stick colla Ø 12/100 trasparente
- ▶ 6 stick colla Ø 12/100 miele

Classe di isolamento:

- ▶ CLASS 1

Conforme alle direttive:

- ▶ ROHS
- ▶ 2006/42/CE



CODICE	ARTICOLO	PACK
0195138	GRIP 20XP	5

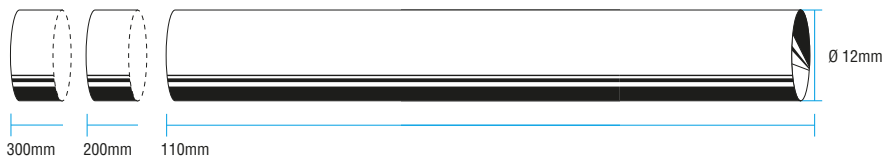

Colori colle disponibili:

- Trasparente
- Bianco
- Miele
- Rosso
- Nero
- Grigio

**M12 H12**

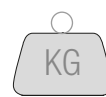

Si consiglia l'utilizzo di colle originali Maestri  
Pag. 109

AC220/240V  
50-60 Hz

0,50



# M 195

Incollatrice elettrica per adesivi termofusibili di linea nuova. Leggera e maneggevole per uso

professionale. Adatta per montaggi e riparazioni su legno, plastica, cartone, carta, stoffa, gomma e

cuoio, posa e riparazione di piastrelle e porcellane. Per colle standard Ø 12 mm.

CODICE	ARTICOLO	PACK
0195220	M 195 RED LINE	1

**PROFESSIONAL**

Ugello antigoccia con protezione in silicone.



Potenza 120W.

Massima estrusione colla/ora: 1,1kg/h.

Cavalletto d'appoggio.



Interruttore on/off.



Disponibile in:



incluso:

- ▶ 1 ugello di ricambio

Conforme alle direttive:

- ▶ ROHS
- ▶ 2006/42/CE

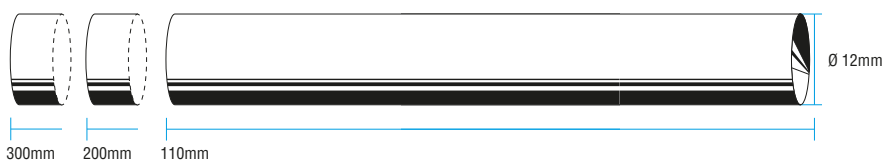

Colori colle disponibili:

- Trasparente
- Bianco
- Miele
- Rosso
- Nero
- Grigio

**M12 H12**

Si consiglia l'utilizzo di colle originali Maestri  
Pag. 109

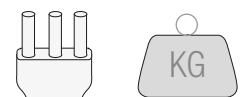

AC220/240V 50-60 Hz 0,47

## INCOLLATRICI

*Incollatrici elettriche per adesivi termofusibili di linea nuova. Leggere e maneggevoli per uso*

*professionale. Adatte per montaggi e riparazioni su legno, plastica, cartone, carta, stoffa, gomma e*

*cuoio, posa e riparazione di piastrelle e porcellane. Per colle standard Ø 12 mm.*

### PROFESSIONAL

Ugello antigoccia svitabile, intercambiabile.



Potenza 220W.

Massima estrusione colla/ora: 1,2 kg/h.

Cavalletto d'appoggio.



Termostato regolabile per il controllo della temperatura d'esercizio.



Disponibile in:



inclusi:

- ▶ 1 ugello di ricambio
- ▶ 1 cacciavite

Classe di isolamento:

- ▶ CLASS 1

Conforme alle direttive:

- ▶ ROHS
- ▶ 2006/42/CE

CODICE	ARTICOLO	PACK
0195221	M 220 RED LINE	1

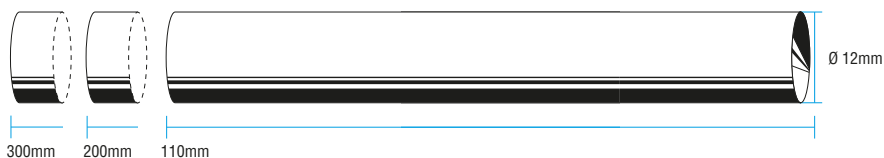

Colori colle disponibili:

- Trasparente
- Bianco
- Miele
- Rosso
- Nero
- Grigio

**M12 | H12**

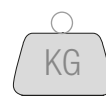

Si consiglia l'utilizzo di colle originali Maestri  
Pag. 109

AC220/240V  
50-60 Hz

0,60  
KG

# M 3350

## Extreme PROFESSIONAL

Ugello antigoccia svitabile, intercambiabile.



Potenza 300W

Massima estrusione colla/ora: 1,5 kg/h.

Termostato regolabile per il controllo della temperatura d'esercizio.



Cavalletto d'appoggio.



Disponibile in:



inclusi:

- ▶ 1 ugello di ricambio

Classe di isolamento:

- ▶ CLASS 1

Conforme alle direttive:

- ▶ ROHS
- ▶ 2006/42/CE

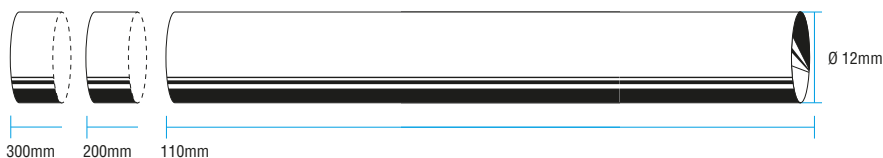

Colori colle disponibili:

- Trasparente
- Bianco
- Miele
- Rosso
- Nero
- Grigio

**M12 H12**

Si consiglia l'utilizzo di colle originali Maestri  
Pag. 109

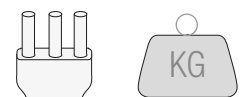

AC220/240V 50-60 Hz 0,70

## INCOLLATRICE

*Incollatrice elettrica per adesivi termofusibili potente, per grandi produzioni e lavori*

*intensivi. Adatta ad un uso professionale per montaggi e riparazioni su legno, plastica, cartone,*

*carta, stoffa, gomma e cuoio, posa e riparazione di piastrelle e porcellane. Per colle standard Ø 12 mm.*

### Extreme PROFESSIONAL

Ugello antigoccia svitabile, intercambiabile.



Potenza 400W.

Massima estrusione colla/ora: 1,8 kg/h.

Termostato regolabile per il controllo della temperatura d'esercizio.



Interruttore on/off.



Disponibile in:



inclusi:

- ▶ 1 ugello di ricambio
- ▶ 1 cacciavite

Classe di isolamento:

- ▶ CLASS 1

Conforme alle direttive:

- ▶ ROHS
- ▶ 2006/42/CE

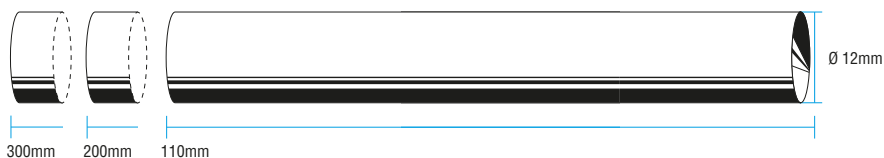

Colori colle disponibili:

- Trasparente
- Bianco
- Miele
- Rosso
- Nero
- Grigio

**M12 | H12**

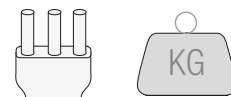

Si consiglia l'utilizzo di colle originali Maestri  
Pag. 109

AC220/240V  
50-60 Hz

1,05

## INCOLLATRICE AVANZAMENTO ELETTRONICO



Incollatrice con innovativo dispositivo elettronico di avanzamento colla per i lavori più intensi, dov'è richiesto

un'alta capacità di estrusione per non affaticare la mano. Adatta ad un uso professionale per montaggi e riparazioni su legno,

plastica, cartone, carta, stoffa, gomma, cuoio, posa e riparazione di piastrelle e porcellane. Per colle standard Ø 12 mm.

# M812 MG

CODICE	ARTICOLO	PACK
0291114	M812 MG	1

## Extreme PROFESSIONAL

Ugello antigoccia svitabile, intercambiabile.



Potenza 450W.

Massima estrusione colla/ora: 2,5 kg/h.

Indicatore di temperatura: luce verde pronta all'uso.

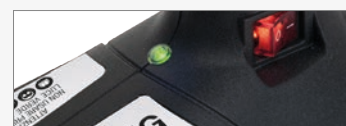

Interruttore on/off.



Disponibile in:



inclusi:

- ▶ 1 ugello di ricambio

Classe di isolamento:

- ▶ CLASS 1

Conforme alle direttive:

- ▶ ROHS
- ▶ 2006/42/CE

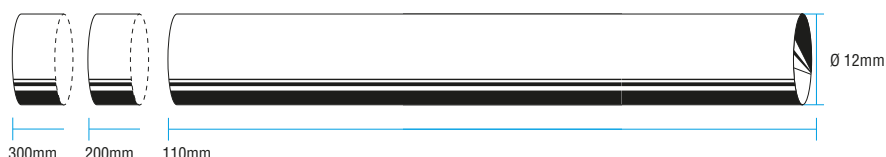

Colori colle disponibili:

- Trasparente
- Bianco
- Miele
- Rosso
- Nero
- Grigio

**M12 H12**

Si consiglia l'uso di colle originali Maestri  
Pag. 109

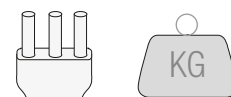

AC220/240V  
50-60 Hz

1,40



# M7/M12/H12 L12

## STICK COLLA TERMOFUSIBILE

Per assemblare, incollare e riparare su legno, plastica, cartone, carta, stoffa, metallo pre-riscaldato, gomma, cuoio.  
Posa e riparazione di piastrelle e porcellane.  
Bigiotteria, fai da te.

Prodotto Europeo conforme al regolamento.

► REACH (CE) n°1907/2006

MADE in ITALY



Maestri, da sempre sensibile alla salute ambientale, ha scelto di utilizzare energia derivante da fonti rinnovabili per la produzione di questo articolo.

**Green energy**  
Maestri da sempre sensibile alla salute ambientale, ha scelto di utilizzare energia derivante da fonti rinnovabili per la produzione di questo articolo.  
**MADE IN ITALY**

**COLLA TERMOFUSIBILE  
HOT MELT GLUE STICKS**



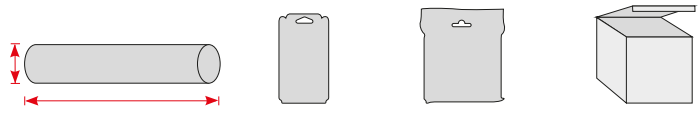

CODICE	ARTICOLO	PACK	STICK	BLISTER	SACCHETTO	SCATOLA
1195207	M 12/200 TRASPARENTE	10	Ø 12 mm / 200 mm		● 1 kg	
1195210	M 12/200 MIELE	10	Ø 12 mm / 200 mm		● 1 kg	
1195212	M 12/200 MIELE SPECIFICA PER CARTONI LUCIDI	10	Ø 12 mm / 200 mm		● 1 kg	
1195213	M 12/200 BIANCA	5	Ø 12 mm / 200 mm			○ 5 kg
1195209	M 12/200 TRASPARENTE	5	Ø 12 mm / 200 mm			● 5 kg
1195215	M 12/200 MIELE	5	Ø 12 mm / 200 mm			● 5 kg
1196710	M 12/200 TRASPARENTE	10	Ø 12 mm / 200 mm	● 280 g		
1196711	M 12/200 BIANCA	10	Ø 12 mm / 200 mm	○ 280 g		
1196712	M 12/200 MIELE	10	Ø 12 mm / 200 mm	● 280 g		
1195230	H 12/200 TRASPARENTE	5	Ø 12 mm / 200 mm			● 5 kg
1195234	H 12/200 TRASPARENTE	10	Ø 12 mm / 200 mm		● 1 kg	
1195250	H 12/300 TRASPARENTE	10	Ø 12 mm / 300 mm			● 10 kg
1195252	H 12/300 BIANCA	10	Ø 12 mm / 300 mm			○ 10 kg
1196720	M 12/110 TRASPARENTE	12	Ø 12 mm / 110 mm	● 100 g		
1196721	M 12/110 ROSSA	12	Ø 12 mm / 110 mm	● 100 g		
1196722	M 12/110 NERA	12	Ø 12 mm / 110 mm	● 100 g		
1196723	M 12/110 GRIGIA	12	Ø 12 mm / 110 mm	● 100 g		
1196740	M 7/100 TRASPARENTE	24	Ø 7 mm / 100 mm	● 70 g		
1196750	M 7/100 TRASPARENTE	36	Ø 7 mm / 100 mm		● 200 g	
1295111	MIELE 213/43	10	Ø 43 mm / 43 mm			● 10 Kg
1195102	L 12/200 TRASPARENTE BASSA TEMPERATURA	5	Ø 12 mm / 200 mm		● 1 Kg	

# FASTENING

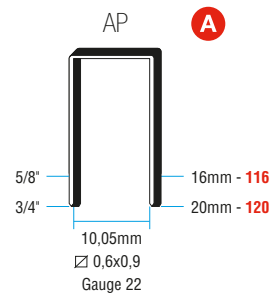
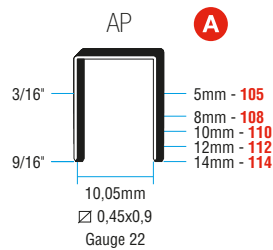
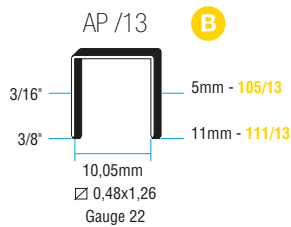

CODICE	ARTICOLO	PACK
1101503	105/13 AP - 5.000	240.000
>1110220	RO-MA 111/13 AP - 672	15

> blister

CODICE	ARTICOLO	PACK
1101301	105 AP - 5.000	300.000
1101303	108 AP - 5.000	240.000
1101207	112 AP - 5.000	150.000
1101209	114 AP - 5.000	120.000
>1110125	RO-MA 110 AP - 960	15
>1110126	RO-MA 112 AP - 840	15
>1110128	RO-MA 114 AP - 720	15

> blister

CODICE	ARTICOLO	PACK
1110130	RO-MA 116 AP - 600	15
1110132	RO-MA 120 AP - 480	15

> blister

PAG			
5	7	19	23

PAG							
5	7	9	11	13	18	19	21
23	25	29	33	37			

PAG		
11	13	37



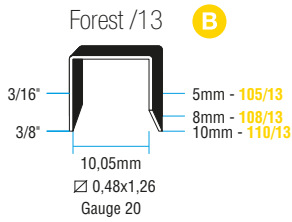

CODICE	ARTICOLO	PACK
1101401	105/13 FOREST - 5.000	240.000
1101403	108/13 FOREST - 5.000	180.000
1101405	110/13 FOREST - 5.000	120.000
1101402	105/13 FOREST BLACK EDITION - 5.000	50.000
1101404	108/13 FOREST BLACK EDITION - 5.000	50.000
1101406	110/13 FOREST BLACK EDITION - 5.000	50.000
>1110201	RO-MA 105/13 FOREST - 1.092	15
>1110203	RO-MA 108/13 FOREST - 840	15
>1110205	RO-MA 110/13 FOREST - 672	15

PAG			
5	7	19	23

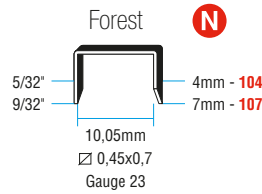

CODICE	ARTICOLO	PACK
1101001	104 FOREST - 5.000	480.000
1101007	107 FOREST - 5.000	360.000

PAG	
5	

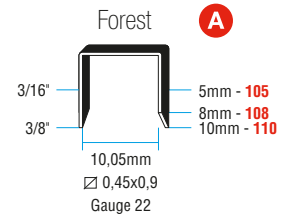

CODICE	ARTICOLO	PACK
1101201	105 FOREST - 5.000	300.000
1101203	108 FOREST - 5.000	240.000
1101205	110 FOREST - 5.000	210.000
1101202	105 FOREST BLACK EDITION - 5.000	50.000
1101204	108 FOREST BLACK EDITION - 5.000	50.000
1101206	110 FOREST BLACK EDITION - 5.000	50.000
>1110120	RO-MA 105 FOREST - 1.764	15
>1110122	RO-MA 108 FOREST - 1.764	15
>1110124	RO-MA 110 FOREST - 1.008	15

PAG						
5	7	9	11	13	18	19
23	25	29	33	37		21

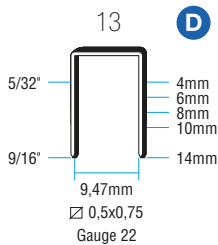

CODICE	ARTICOLO	PACK
1101701	M 13/4 ZINCATI - 5.000	80.000
1101703	M 13/6 ZINCATI - 5.000	70.000
1101705	M 13/8 ZINCATI - 5.000	110.000
1101707	M 13/10 ZINCATI - 5.000	80.000
1101711	M 13/14 ZINCATI - 5.000	60.000
>1110501	RO-MA 13/4 ZINCATI - 3.360	15
>1110503	RO-MA 13/6 ZINCATI - 2.240	15
>1110505	RO-MA 13/8 ZINCATI - 2.240	15
>1110507	RO-MA 13/10 ZINCATI - 1.120	15
>1110509	RO-MA 13/14 ZINCATI - 1.120	15

PAG					
7	9	11	15	23	37

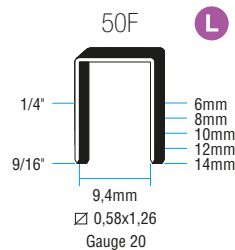

CODICE	ARTICOLO	PACK
1101801	M 50F/6 ZINCATI - 10.000	180.000
1101802	M 50F/8 ZINCATI - 5.000	160.000
1101803	M 50F/10 ZINCATI - 5.000	130.000
1101804	M 50F/12 ZINCATI - 5.000	110.000
1101805	M 50F/14 ZINCATI - 5.000	100.000
>1110601	RO-MA 50F/6 ZINCATI - 1.176	15
>1110603	RO-MA 50F/8 ZINCATI - 840	15
>1110605	RO-MA 50F/10 ZINCATI - 672	15
>1110607	RO-MA 50F/12 ZINCATI - 588	15
>1110609	RO-MA 50F/14 ZINCATI - 504	15

PAG				
7	11	15	23	41

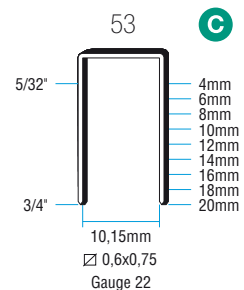

CODICE	ARTICOLO	PACK
1101603	M 53/6 ZINCATI - 5.000	280.000
1101605	M 53/8 ZINCATI - 5.000	270.000
1101607	M 53/10 ZINCATI - 5.000	240.000
1101609	M 53/12 ZINCATI - 5.000	210.000
1101611	M 53/14 ZINCATI - 5.000	180.000
1101613	M 53/16 ZINCATI - 4.000	144.000
1101615	M 53/18 ZINCATI - 3.000	126.000
1101616	M 53/20 ZINCATI - 3.000	126.000
>1110320	RO-MA 53/4 ZINCATI - 2.940	15
>1110322	RO-MA 53/6 ZINCATI - 1.960	15
>1110324	RO-MA 53/8 ZINCATI - 1.960	15
>1110326	RO-MA 53/10 ZINCATI - 1.120	15
>1110328	RO-MA 53/12 ZINCATI - 980	15
>1110330	RO-MA 53/14 ZINCATI - 840	15
>1110332	RO-MA 53/16 ZINCATI - 700	15
>1110334	RO-MA 53/18 ZINCATI - 560	15
>1110336	RO-MA 53/20 ZINCATI - 560	15

PAG						
5	7	9	11	13	16	17
23	25	33	35	37		21

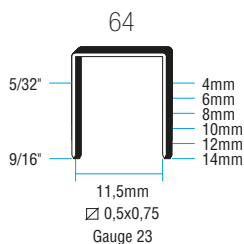

CODICE	ARTICOLO	PACK
1201001	64/4 BRONZATI - 20.000	360.000
1201003	64/6 BRONZATI - 10.000	360.000
1201005	64/8 BRONZATI - 10.000	270.000
1201007	64/10 BRONZATI - 10.000	270.000
1201009	64/12 BRONZATI - 10.000	180.000
1201011	64/14 BRONZATI - 10.000	180.000

PAG

48

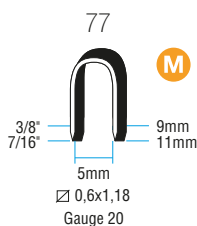

CODICE	ARTICOLO	PACK
1102001	77/9 ZINCATI - 1.000	30.000
1102003	77/11 ZINCATI - 1.000	30.000
>1130501	RO-MA 77/9 ZINCATI - 1.440	15
>1130503	RO-MA 77/11 ZINCATI - 1.152	15

> blister

PAG

14

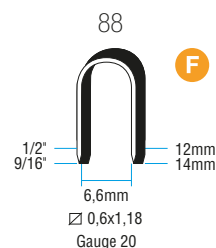

CODICE	ARTICOLO	PACK
1102005	88/12 ZINCATI - 1.000	30.000
1102007	88/14 ZINCATI - 1.000	30.000
> 1130505	RO-MA 88/12 ZINCATI - 1.152	15
> 1130507	RO-MA 88/14 ZINCATI - 864	15

> blister

PAG

14

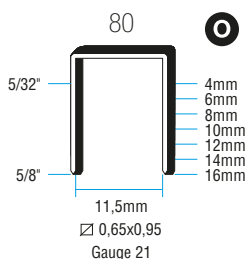

CODICE	ARTICOLO	PACK
1201103	80/4 BRONZATI - 10.000	300.000
1201105	80/6 BRONZATI - 10.000	240.000
1201107	80/8 BRONZATI - 10.000	180.000
1201109	80/10 BRONZATI - 10.000	180.000
1201111	80/12 BRONZATI - 10.000	120.000
1201113	80/14 BRONZATI - 10.000	120.000
1201117	80/16 BRONZATI - 10.000	120.000
1201160	80/6 RED EDITION BRONZATI - 5.000	50.000
1201161	80/8 RED EDITION BRONZATI - 5.000	50.000
1201162	80/10 RED EDITION BRONZATI - 5.000	50.000
1201163	80/12 RED EDITION BRONZATI - 5.000	50.000
1201164	80/14 RED EDITION BRONZATI - 5.000	50.000
1201165	80/16 RED EDITION BRONZATI - 5.000	50.000
1201401	80/4 GALVA - 10.000	200.000
1201403	80/6 GALVA - 10.000	200.000
1201405	80/8 GALVA - 10.000	200.000
1201407	80/10 GALVA - 10.000	100.000
1201409	80/12 GALVA - 10.000	100.000
1201411	80/14 GALVA - 10.000	100.000
1201413	80/16 GALVA - 10.000	100.000
1201901	80/4 INOX - 20.000	240.000
1201903	80/6 INOX - 10.000	240.000
1201905	80/8 INOX - 10.000	180.000
1201907	80/10 INOX - 10.000	180.000
1201909	80/12 INOX - 10.000	120.000
1201911	80/14 INOX - 10.000	120.000
>1111230	RO-MA 80/8 INOX - 1.128	15
> 1111231	RO-MA 80/10 INOX - 940	15
> 1111232	RO-MA 80/14 INOX - 752	15

> blister

PAG

11 37 41 46 47

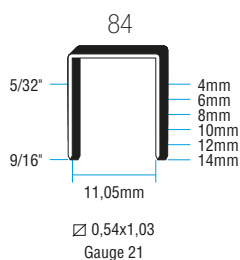

CODICE	ARTICOLO	PACK
1201201	84/4 BRONZATI - 10.000	200.000
1201203	84/6 BRONZATI - 10.000	240.000
1201205	84/8 BRONZATI - 10.000	180.000
1201207	84/10 BRONZATI - 10.000	180.000
1201209	84/12 BRONZATI - 10.000	120.000
1201211	84/14 BRONZATI - 10.000	120.000

PAG

49

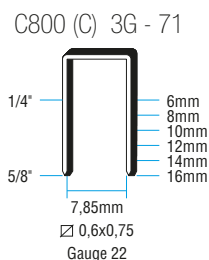

CODICE	ARTICOLO	PACK
1261104	C 806 ZINCATI - 25.000	280.000
1261108	C 808 ZINCATI - 28.000	224.000
1261113	C 810 ZINCATI - 25.000	200.000
1261116	C 812 ZINCATI - 35.000	140.000
1261119	C 814 ZINCATI - 32.000	128.000
1261124	C 816 ZINCATI - 27.000	108.000

PAG

11 41

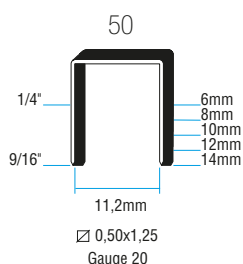

CODICE	ARTICOLO	PACK
11	41	

PAG

11 41

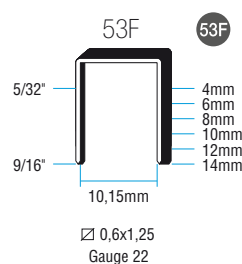

CODICE	ARTICOLO	PACK
7	23	

PAG

7 23

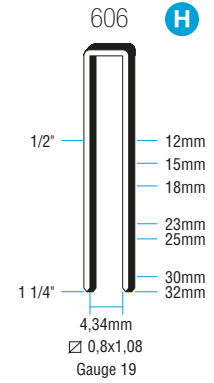
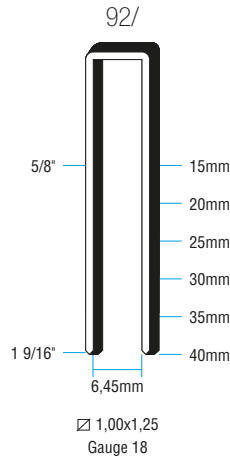
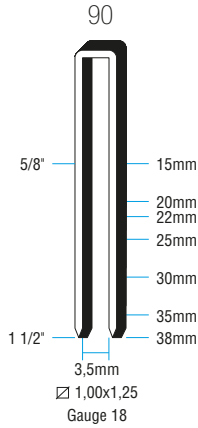

CODICE	ARTICOLO	PACK
1202001	90/15 BRONZATI - 5.000	80.000
1202002	90/20 BRONZATI - 5.000	60.000
1202003	90/22 BRONZATI - 5.000	50.000
1202005	90/25 BRONZATI - 5.000	50.000
1202007	90/30 BRONZATI - 5.000	40.000
1202011	90/35 BRONZATI - 5.000	40.000
1202013	90/38 BRONZATI - 5.000	30.000

CODICE	ARTICOLO	PACK
1202100	92/15 BRONZATI - 7.000	70.000
1202101	92/20 BRONZATI - 5.000	60.000
1202103	92/25 BRONZATI - 4.000	48.000
1202105	92/30 BRONZATI - 4.000	40.000
1202107	92/35 BRONZATI - 3.000	30.000
1202109	92/40 BRONZATI - 3.000	30.000

CODICE	ARTICOLO	PACK
1202301	M 606/12 ZINCATI - 5.000	100.000
1202303	M 606/15 ZINCATI - 5.000	100.000
1202307	M 606/23 ZINCATI - 5.000	50.000
1202310	M 606/30 ZINCATI - 2.200	24.200
1202311	M 606/32 ZINCATI - 2.200	24.200
1202317	M 606/18 DP ZINCATI - 4.800	57.600
1202319	M 606/23 DP ZINCATI - 4.800	57.600
>1110420	RO-MA 606/12 ZINCATI - 1.176	15
> 1110422	RO-MA 606/15 ZINCATI - 980	15
> 1110424	RO-MA 606/18 ZINCATI - 784	15
> 1110426	RO-MA 606/23 ZINCATI - 588	15
> 1110428	RO-MA 606/25 ZINCATI - 588	15

PAG	
51	53

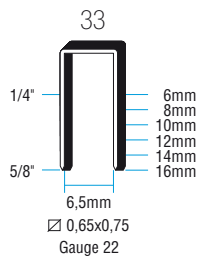

PAG	
41	

PAG	
50	

PAG	
37	41

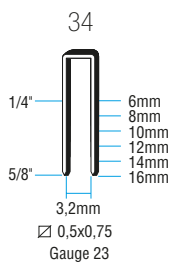

PAG	
11	

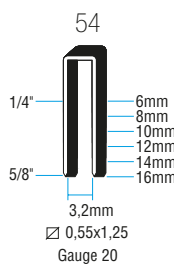

PAG	
11	41

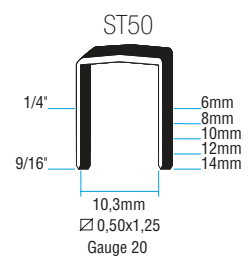

PAG	
11	

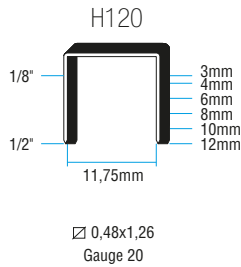

□ 0,48x1,26  
Gauge 20

CODICE	ARTICOLO	PACK
1261502	H 123 ZINCATI - 10.000	100.000
1261507	H 124 ZINCATI - 16.200	97.200
1261515	H 126 ZINCATI - 34.000	136.000
1261522	H 128 ZINCATI - 30.000	120.000
1261528	H 1210 ZINCATI - 8.400	100.800
1261536	H 1212 ZINCATI - 14.000	56.000
1261511	H124 INOX - 5.000	260.000
1261518	H126 INOX - 3.000	70.000
1261540	H1212 INOX - 7.000	56.000

PAG

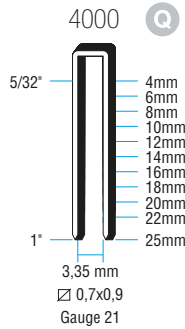

□ 0,7x0,9  
Gauge 21

CODICE	ARTICOLO	PACK
1201300	4004 BRONZATI - 20.000	600.000
1201301	4006 BRONZATI - 20.000	400.000
1201303	4008 BRONZATI - 20.000	320.000
1201305	4010 BRONZATI - 10.000	300.000
1201307	4012 BRONZATI - 10.000	250.000
1201309	4014 BRONZATI - 10.000	200.000
1201311	4016 BRONZATI - 10.000	180.000
1201313	4018 BRONZATI - 10.000	160.000
1201315	4020 BRONZATI - 10.000	120.000
1201317	4022 BRONZATI - 10.000	120.000
1201318	4025 BRONZATI - 10.000	100.000
1201320	4016 DP BRONZATI - 10.000	100.000
1201322	4020 DP BRONZATI - 10.000	100.000

PAG

41

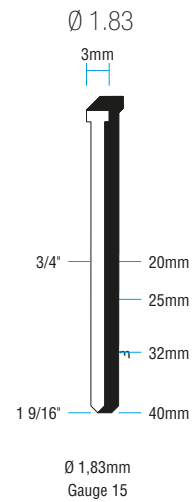

□ 1,83mm  
Gauge 15

CODICE	ARTICOLO	PACK
1233149	Ø1.83 - 20 mm 3.000	30.000
1233150	Ø1.83 - 25 mm 3.000	15.000
1233152	Ø1.83 - 32 mm 1.500	15.000
1233153	Ø1.83 - 40 mm 1.500	15.000

PAG

56

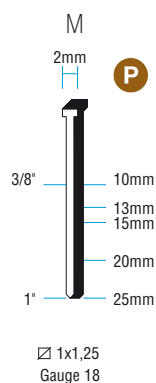

□ 1x1,25  
Gauge 18

CODICE	ARTICOLO	PACK
>1130800	RO-MA M10 ZINCATI - 3.500	15
>1130801	RO-MA M13 ZINCATI - 2.500	15
>1130803	RO-MA M15 ZINCATI - 1.700	15
>1130805	RO-MA M20 ZINCATI - 1.500	15
>1130807	RO-MA M25 ZINCATI - 1.200	15

> blister

PAG

7 9 11 13 17 21 23 25  
29 33 35

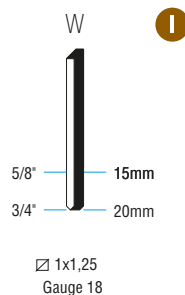

□ 1x1,25  
Gauge 18

CODICE	ARTICOLO	PACK
>1130820	RO-MA W15 ZINCATI - 2.000	15
>1130822	RO-MA W20 ZINCATI - 2.000	15

> blister

PAG

11 13 33

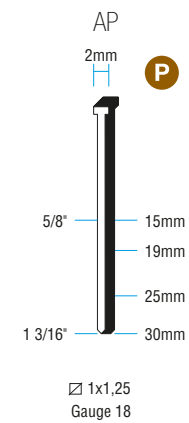

□ 1x1,25  
Gauge 18

CODICE	ARTICOLO	PACK
1231131	AP15 - 15 mm - 5.000	150.000
1231133	AP19 - 19 mm - 5.000	100.000
1231135	AP25 - 25 mm - 5.000	100.000
1231137	AP30 - 30 mm - 5.000	50.000

PAG

37 39 41 43

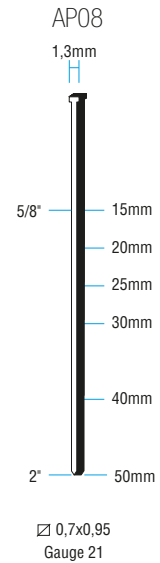
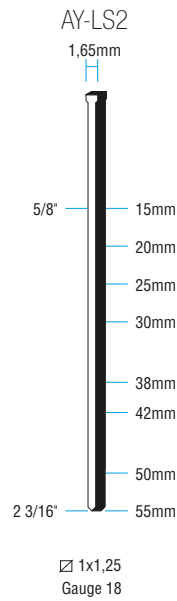
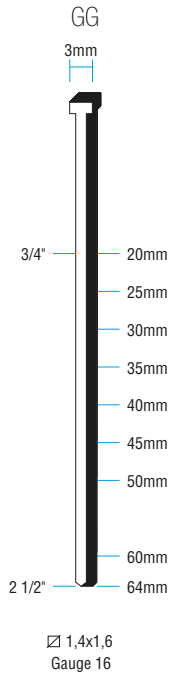

CODICE	ARTICOLO	PACK
1233100	<b>GG20 - 20 mm - 4.000</b>	80.000
1233101	<b>GG25 - 25 mm - 4.000</b>	64.000
1233103	<b>GG30 - 30 mm - 4.000</b>	48.000
1233105	<b>GG35 - 35 mm - 4.000</b>	48.000
1233107	<b>GG40 - 40 mm - 4.000</b>	32.000
1233109	<b>GG45 - 45 mm - 4.000</b>	32.000
1233111	<b>GG50 - 50 mm - 4.000</b>	32.000
1233120	<b>GG60 - 60 mm - 4.000</b>	32.000
1233121	<b>GG64 - 64 mm - 4.000</b>	32.000

PAG	
56	

CODICE	ARTICOLO	PACK
1273301	<b>AY-LS2 15 mm GALVA - 8.000</b>	128.000
1273303	<b>AY-LS2 20 mm GALVA - 7.000</b>	112.000
1273305	<b>AY-LS2 25 mm GALVA - 5.000</b>	80.000
1273307	<b>AY-LS2 30 mm GALVA - 4.000</b>	64.000
1273309	<b>AY-LS2 38 mm GALVA - 4.000</b>	64.000
1273311	<b>AY-LS2 42 mm GALVA - 3.000</b>	48.000
1273313	<b>AY-LS2 50 mm GALVA - 2.500</b>	40.000
1273315	<b>AY-LS2 55 mm GALVA - 2.000</b>	32.000

PAG	
57	

CODICE	ARTICOLO	PACK
1231301	<b>AP08 - 15 mm - 6.100</b>	61.000
1231303	<b>AP08 - 20 mm - 6.100</b>	61.000
1231305	<b>AP08 - 25 mm - 6.100</b>	61.000
1231307	<b>AP08 - 30 mm - 6.100</b>	61.000
1231309	<b>AP08 - 40 mm - 4.000</b>	40.000
1231310	<b>AP08 - 50 mm - 4.000</b>	40.000

PAG	
60	61

## FASTENING

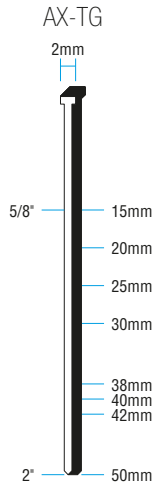

□ 1x1,25  
Gauge 18

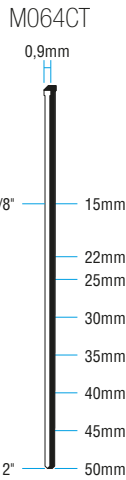

∅ 0,64mm  
Gauge 23

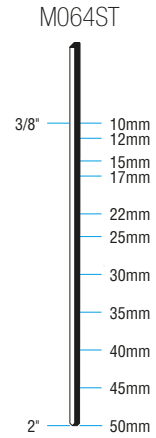

∅ 0,64mm  
Gauge 23

CODICE	ARTICOLO	PACK
1164001	AX-TG 15 mm - 5.000	150.000
1164003	AX-TG 20 mm - 5.000	100.000
1164005	AX-TG 25 mm - 5.000	100.000
1164007	AX-TG 30 mm - 5.000	50.000
1164009	AX-TG 38 mm - 5.000	50.000
1164011	AX-TG 40 mm - 5.000	50.000
1164012	AX-TG 42 mm - 6.000	36.000
1164014	AX-TG 50 mm - 5.000	50.000

PAG

53 54 55 57

CODICE	ARTICOLO	PACK
1234120	M064CT 15 mm - 20.000	480.000
1234122	M064CT 22 mm - 20.000	320.000
1234124	M064CT 25 mm - 20.000	320.000
1234126	M064CT 30 mm - 10.000	240.000
1234127	M064CT 35 mm - 10.000	180.000
1234128	M064CT 40 mm - 10.000	180.000
1234129	M064CT 45 mm - 10.000	180.000
1234130	M064CT 50 mm - 10.000	120.000

PAG

58 59

CODICE	ARTICOLO	PACK
1234101	M064ST 10 mm - 30.000	240.000
1234103	M064ST 12 mm - 20.000	360.000
1234105	M064ST 15 mm - 20.000	360.000
1234107	M064ST 17 mm - 20.000	360.000
1234109	M064ST 22 mm - 10.000	180.000
1234111	M064ST 25 mm - 10.000	180.000
1234113	M064ST 30 mm - 10.000	180.000
1234114	M064ST 35 mm - 10.000	240.000
1234115	M064ST 40 mm - 10.000	180.000
1234116	M064ST 45 mm - 10.000	180.000
1234117	M064ST 50 mm - 10.000	120.000

PAG

58 59

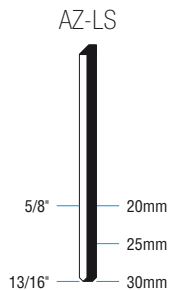

□ 1x1,25  
Gauge 18

CODICE	ARTICOLO	PACK
1271117	AZ-LS 20 mm GALVA - 8.000	128.000
1271121	AZ-LS 25 mm GALVA - 7.000	112.000
1271123	AZ-LS 30 mm GALVA - 6.000	96.000

PAG

57

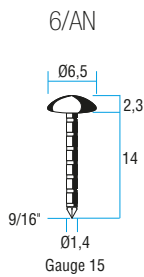

CODICE	ARTICOLO	PACK
1292102	6/AN OTTONATE - 4.000	36.000
1292103	6/AN NICHELATE - 4.000	36.000
1292107	6/AN OTTONE NOCE - 4.000	36.000
1292108	6/AN OTTONE NOCE ZAPPONATE - 4.000	36.000
1292110	6/AN NICKEL FREE - 4.000	36.000
1292111	6/AN NICKEL FREE GUN METAL - 4.000	36.000
1292112	6/AN OTTONE BRUNITO - 4.000	36.000
1292129	6/AN GUN METAL - 4.000	36.000
1292115	6/AN GUN METAL NERO - 4.000	36.000
1292120	6/AN SFUMATE - 4.000	36.000
1292104	6/AN OTTONE VECCHIO - 4.000	36.000
1292106	6/AN NICHELATE GAMBO 10 mm - 4.000	36.000
1292109	6/AN ORO VECCHIO LUCIDO - 4.000	36.000
1292114	6/AN NICKEL FREE GAMBO 10 mm - 4.000	36.000
1292116	6/AN OTTONE NOCE GAMBO 10 mm - 4.000	36.000
1292126	6/AN NICHEL VECCHIO - 4.000	36.000

PAG		
63		

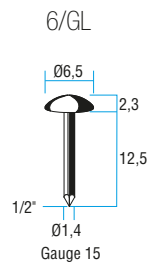

CODICE	ARTICOLO	PACK
1292012	6/GL OTTONE ZAPPONATE - 4.000	36.000
1292013	6/GL OTTONE NOCE ZAPPONATE - 4.000	36.000
1292001	6/GL SFUMATE - 4.000	36.000
1292002	6/GL OTTONATE - 4.000	36.000
1292003	6/GL NICHELATE - 4.000	36.000
1292009	6/GL OTTONE NOCE - 4.000	36.000
1292010	6/GL NICKEL FREE - 4.000	36.000
1292025	6/GL GUN METAL - 4.000	36.000
1292011	6/GL NICKEL FREE GUN METAL - 4.000	36.000
1292015	6/GL OTTONE BRUNITO - 4.000	36.000
1292004	6/GL ORO VECCHIO - 4.000	36.000
1292027	6/GL OTTONE FREE - 4.000	36.000

PAG		
63		

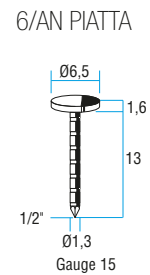

CODICE	ARTICOLO	PACK
1292140	6/AN OTTONATE TESTA PIATTA - 4.000	36.000
1292142	6/AN OTTONE VECCHIO TESTA PIATTA - 4.000	36.000
1292143	6/AN NICHELATE TESTA PIATTA - 4.000	36.000

PAG		
63		

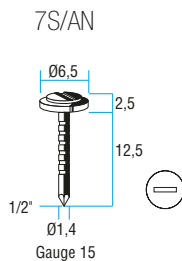

CODICE	ARTICOLO	PACK
1292151	7S/AN OTTONATE TESTA A VITE - 4.000	36.000
1292153	7S/AN NICHELATE TESTA A VITE - 4.000	36.000
1292157	7S/AN NICKEL FREE TESTA A VITE - 4.000	36.000
1292158	7S/AN OTTONE FREE TESTA A VITE - 4.000	36.000

PAG		
63		

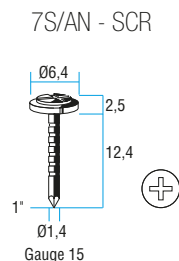

CODICE	ARTICOLO	PACK
1292154	7S/AN OTTONATE TESTA A VITE SCR - 4.000	36.000

PAG		
63		

## FASTENING

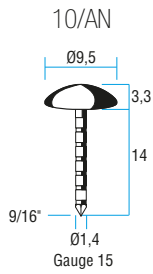

CODICE	ARTICOLO	PACK
1292501	10/AN OTTONATE - 2.000	18.000
1292502	10/AN NICHELATE - 2.000	18.000
1292510	10/AN GUN METAL - 2.000	18.000
1292506	10/AN SFUMATE - 2.000	18.000
1292508	10/AN OTTONE VECCHIO - 2.000	18.000
1292509	10/AN ORO VECCHIO LUCIDO - 2.000	18.000
1292549	10/AN OTTONE NOCE - 2.000	18.000
1292580	10/AN NICHEL FREE - 2.000	18.000

PAG

63

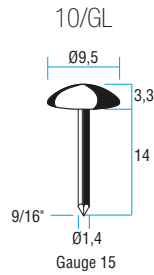

CODICE	ARTICOLO	PACK
1292401	10/GL OTTONATE - 2.000	18.000
1292402	10/GL NICHELATE - 2.000	18.000
1292405	10/GL ORO VECCHIO - 2.000	18.000
1292410	10/GL ORO VECCHIO MARTELLATO - 2.000	18.000
1292412	10/GL SFUMATE - 2.000	18.000
1292403	10/GL NERA - 2.000	18.000
1292404	10/GL BRUEN - 2.000	18.000

PAG

63

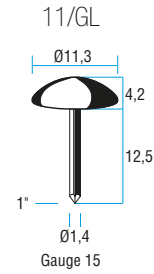

CODICE	ARTICOLO	PACK
1292603	11/GL ORO VECCHIO LUCIDO - 1.333	12.000
1292817	11/GL ORO VECCHIO - 1.333	12.000
1292818	11/GL OTTONATE ZAPPONATE - 1.333	12.000
1292819	11/GL OTTONE VECCHIO - 1.333	12.000
1292815	11,5/GL SFUMATE - 1.333	12.000
1292810	11,5/GL NATURAL - 1.333	12.000
1292811	11,5/GL OXFORD - 1.333	12.000
1292812	11,5/GL FRENCH NATURAL - 1.333	12.000
1292813	11,5/GL NICHEL - 1.333	12.000
1292814	11,5/GL OTTONATE - 1.333	12.000
1292816	11,5/GL NERA - 1.333	12.000

PAG

63

## FRAMING

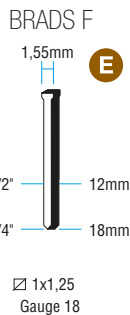

CODICE	ARTICOLO	PACK
1160205	F18 ZINCATO - 5.000/20.000	100.000
> 1130840	RO-MA F12 ZINCATO - 2.000	15
> 1130830	RO-MA F18 ZINCATO - 2.000	15

> blister

PAG

66 67 68 69

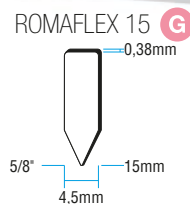

CODICE	ARTICOLO	PACK
1299056	ROMAFLEX 15 - 5.000	80.000
> 1130901	ROMAFLEX 15 - 2.080	15

> blister

PAG

70 71



# PACKAGING

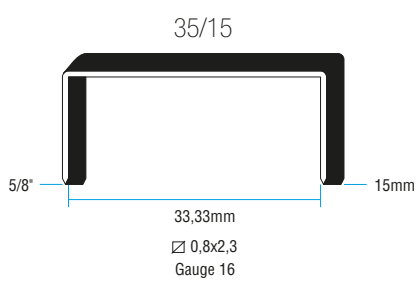

CODICE	ARTICOLO	PACK
1107001	35/15 RAMATI - 2.500	25.000
PAG		
74	75	76 77 80 81

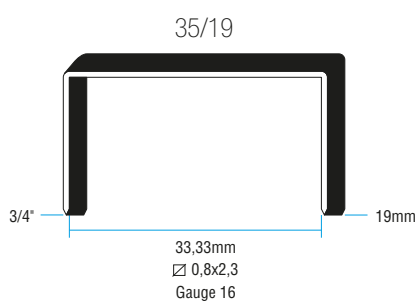

CODICE	ARTICOLO	PACK
1107005	35/19 RAMATI - 2.000	20.000
1107007	35/19 RAMATI NEUTRI - 2.000	20.000
PAG		
74	75	76 77 80 81

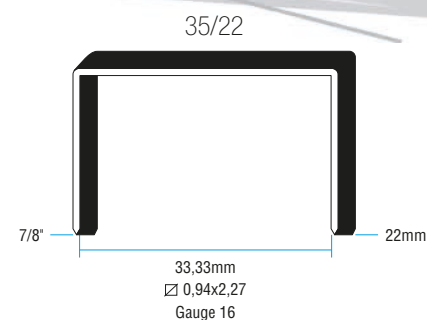

CODICE	ARTICOLO	PACK
1211205	35/22 RAMATI - 1.500	15.000
PAG		
74	75	80 81

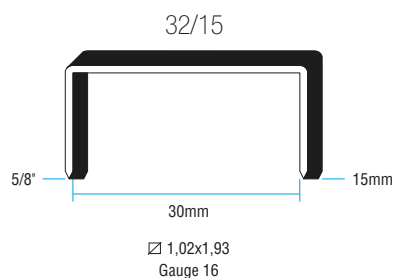

CODICE	ARTICOLO	PACK
1211103	32/15 RAMATI - 2.000	20.000
PAG		

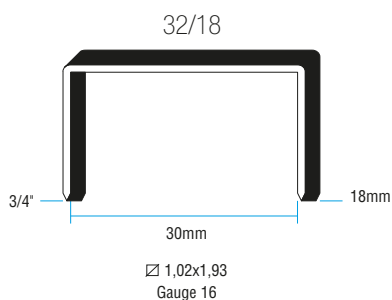

CODICE	ARTICOLO	PACK
1211105	32/18 RAMATI - 2.000	20.000
PAG		

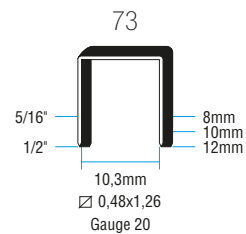

CODICE	ARTICOLO	PACK
1101810	73/8 ZINCATI - 5.000	80.000
1101811	73/10 ZINCATI - 5.000	70.000
1101812	73/12 ZINCATI - 5.000	60.000
PAG		
79		

## PACKAGING

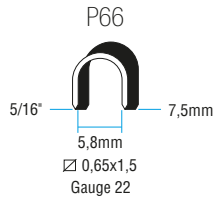

CODICE	ARTICOLO	PACK
1213005	<b>P66 ZINCATI - 5.000</b>	100.000

PAG

613 M (medio)

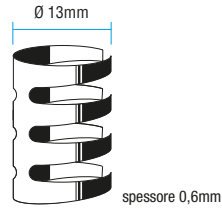

CODICE	ARTICOLO	PACK
> 1291109	<b>613 M - 10.000 pz</b>	100.000

> esecuzioni con dicitura si effettuano per 500.000 pezzi  
chiedere quotazioni

PAG

613 P (pesante)

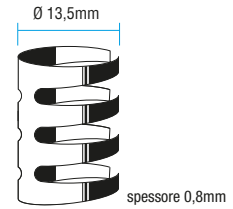

CODICE	ARTICOLO	PACK
> 1291110	<b>613 P - 10.000 pz</b>	100.000

> esecuzioni con dicitura si effettuano per 500.000 pezzi  
chiedere quotazioni

PAG

617 L (leggero)

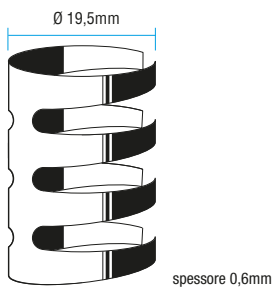

CODICE	ARTICOLO	PACK
> 1291131	<b>617 L - 12.000 pz</b>	48.000

> esecuzioni con dicitura si effettuano per 500.000 pezzi  
chiedere quotazioni

PAG

617 P (pesante)

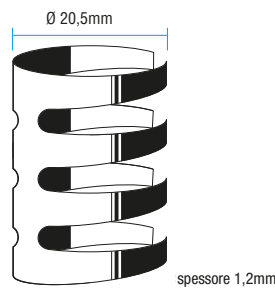

CODICE	ARTICOLO	PACK
> 1291139	<b>617 P - 12.000 pz</b>	48.000

> esecuzioni con dicitura si effettuano per 500.000 pezzi  
chiedere quotazioni

PAG

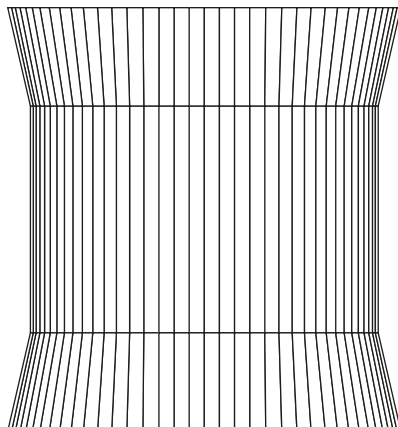

M15/A - M19/A

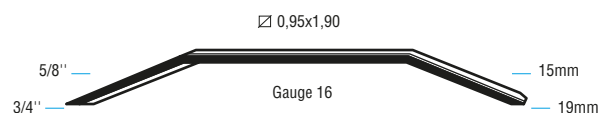

CODICE	ARTICOLO	PACK
1299978	<b>M15/A RAMATI - 1.000</b>	24.000
1299977	<b>M19/A RAMATI - 1.000</b>	24.000

PAG

78

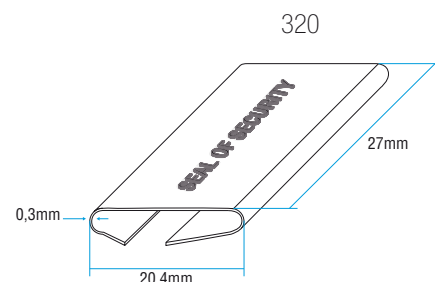
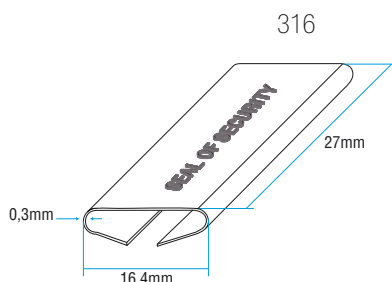
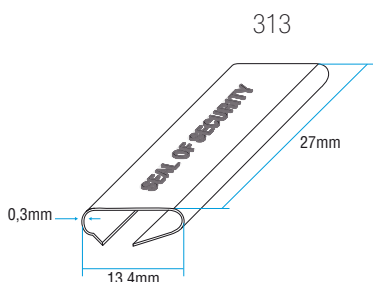

CODICE	ARTICOLO	PACK
1190120	<b>313 ACCIAIO - NEUTRI</b>	3.000
> 1190121	<b>313 ACCIAIO CON DITATURA</b>	2.000

> esecuzioni con dicitura si effettuano per 50.000 pezzi

PAG		
85		

CODICE	ARTICOLO	PACK
1190132	<b>316 ACCIAIO - NEUTRI</b>	3.000
> 1190133	<b>316 ACCIAIO CON DITATURA</b>	3.000

> esecuzioni con dicitura si effettuano per 50.000 pezzi

PAG		
85		

CODICE	ARTICOLO	PACK
1190152	<b>320 ACCIAIO - NEUTRI</b>	3.000
> 1190153	<b>320 ACCIAIO CON DITATURA</b>	2.000

> esecuzioni con dicitura si effettuano per 50.000 pezzi

PAG		
85		

## REGGIA IN METALLO

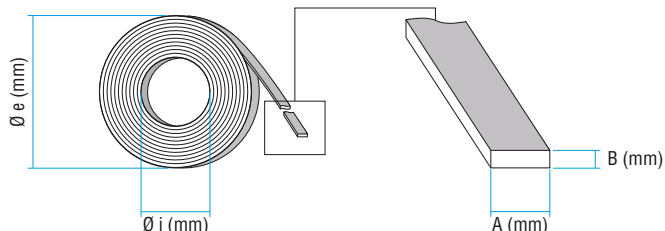

CODICE	ARTICOLO			i	Ø e	PACK (kg)
	A	B	FINIZIONE			
1192115	13 x 0.50	LUCIDA		300 mm - 550 mm	30	
1192125	16 x 0.50	LUCIDA		300 mm - 550 mm	35	
1192135	18 x 0.60	LUCIDA		300 mm - 550 mm	40	
1192145	20 x 0.60	LUCIDA		300 mm - 550 mm	25	
1290415	25 x 1.00	LUCIDA		300 mm - 550 mm	30	
1290423	30 x 1.00	LUCIDA		300 mm - 550 mm	40	
1290431	32 x 1.00	LUCIDA		300 mm - 550 mm	40	
1192127	16 x 0.50	BLUATA - ALTA RESISTENZA		300 mm - 550 mm	60	
1192137	19 x 0.60	BLUATA - ALTA RESISTENZA		300 mm - 550 mm	75	
1192136	19 x 0.60	ZINCATA		300 mm - 550 mm	30	
1192148	20 x 0.60	ZINCATA		300 mm - 550 mm	25	
1192139	19 x 0.60	ZINCATA VERNICIATA		300 mm - 550 mm	35	
PAG						
85	86	87				

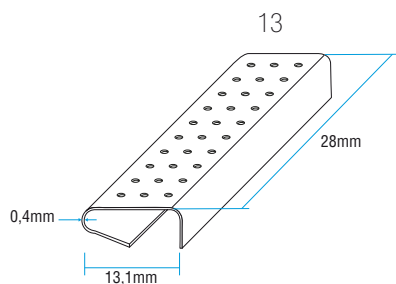

CODICE	ARTICOLO	PACK
> 1190006	<b>13 LA BULINATI</b>	2.500
<i>&gt; esecuzioni con dicitura si effettuano per 50.000 pezzi chiedere quotazioni</i>		
<b>PAG</b>		
91		

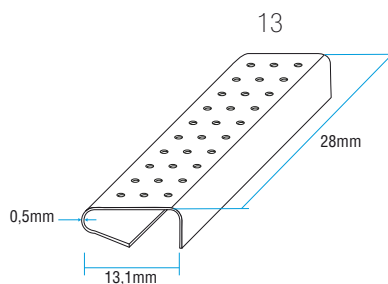

CODICE	ARTICOLO	PACK
> 1190010	<b>13 PA BULINATI</b>	2.500
<i>&gt; esecuzioni con dicitura si effettuano per 50.000 pezzi chiedere quotazioni</i>		
<b>PAG</b>		
91		

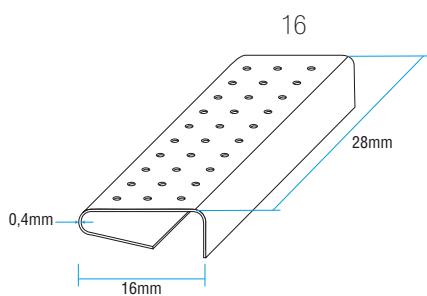

CODICE	ARTICOLO	PACK
> 1190021	<b>16 LA BULINATI</b>	2.000
<i>&gt; esecuzioni con dicitura si effettuano per 50.000 pezzi chiedere quotazioni</i>		
<b>PAG</b>		
91		

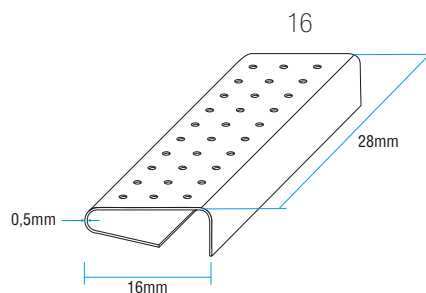

CODICE	ARTICOLO	PACK
> 1190023	<b>16 PA BULINATI</b>	2.000
<i>&gt; esecuzioni con dicitura si effettuano per 50.000 pezzi chiedere quotazioni</i>		
<b>PAG</b>		
91		

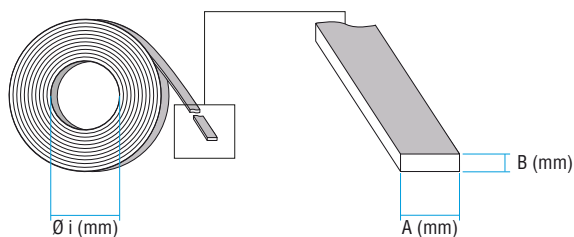

CODICE	ARTICOLO			PP	Ø i (mm)	PACK (mt)
	A	B	COLORE			
1191105	12 x 0.50	NERA		PP	60 mm	4.000
1191107	12 x 0.60	NERA		PP	60 mm	4.000
1191108	12 x 0.80	NERA		PP	60 mm	3.800
1191121	15 x 0.50	NERA		PP	60 mm	3.600
1191125	15 x 0.60	NERA		PP	60 mm	3.600
1191128	15 x 0.80	NERA		PP	60 mm	3.200
1191151	12 x 0.50	NERA		PP	400 mm	3.000
1191153	12 x 0.60	NERA		PP	400 mm	2.500
1191155	12 x 0.80	NERA		PP	400 mm	2.000
1191173	15 x 0.50	NERA		PP	400 mm	2.000
1191175	15 x 0.60	NERA		PP	400 mm	2.000
1191177	15 x 0.80	NERA		PP	400 mm	1.500
1191179	15 x 0.80	BIANCA		PP	400 mm	1.500
PAG						
91	92	93	94	95		

## REGGIA IN PLASTICA TERMOSALDABILE

CODICE	ARTICOLO			PP	Ø i (mm)	PACK (mt)
	A	B	COLORE			
1290306	6 x 0.50	BIANCA		PP	200 mm	4.800
1290304	9 x 0.50	BIANCA		PP	200 mm	4.000
1290305	9 x 0.60	BIANCA		PP	200 mm	3.500
1290308	12 x 0.50	BIANCA		PP	200 mm	3.000
1290307	12 x 0.58	BIANCA		PP	200 mm	3.000
1290312	12 x 0.60	BIANCA		PP	200 mm	2.500
1290311	12 x 0.60	NERA		PP	200 mm	3.000
1290317	12 x 0.80	NERA		PP	200 mm	2.000
1290313	12 x 0.60	BIANCA		PP	280 mm	2.500
1290315	12 x 0.60	BIANCA		PP	400 mm	2.500
1290320	12 x 0.80	BIANCA		PP	400 mm	2.000
1290319	12 x 0.80	NERA		PP	400 mm	2.000
1290323	15 x 0.60	NERA		PP	400 mm	2.000
1290325	15 x 0.80	NERA		PP	400 mm	1.500
1290329	12 x 0.60	VERDE		PET	400 mm	2.500
1290330	15 x 0.60	VERDE		PET	400 mm	2.000
1290326	15 x 0.80	VERDE		PET	400 mm	1.500
1290328	19 x 0.90	VERDE		PET	400 mm	1.000
PAG						
91	92	93	94	95		

# PACKAGING

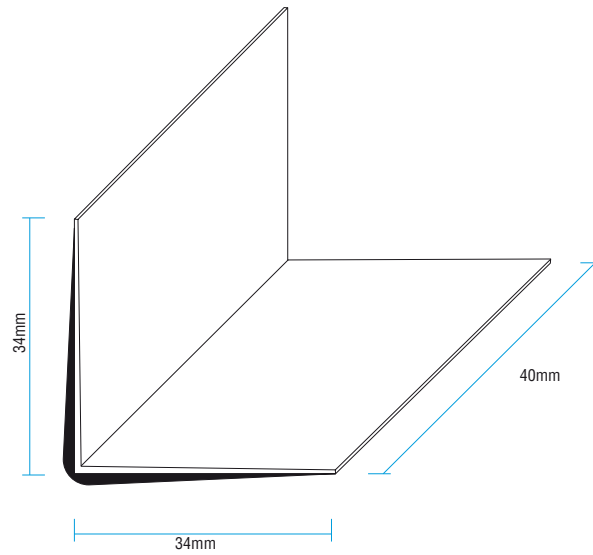

CODICE	ARTICOLO	PACK
1290130	4X4 ANGOLARI MEDI	4.000

PAG

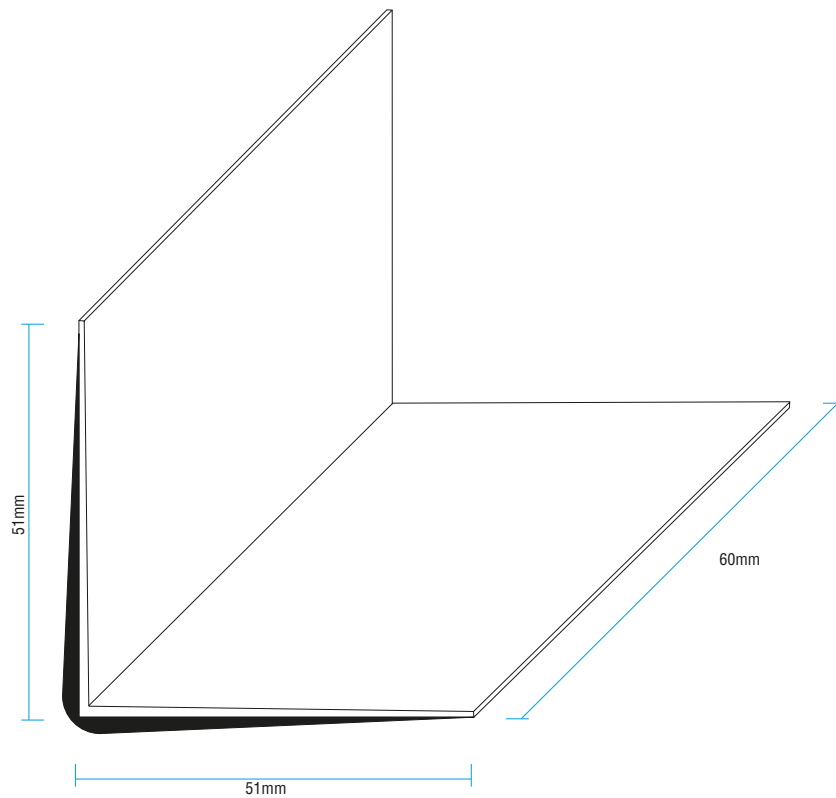

CODICE	ARTICOLO	PACK
1290132	6X6 ANGOLARI GRANDI	1.000

PAG













*dal 1919*

*nei Sistemi di Fissaggio*



## romeo maestri & figli s.p.a.

sistemi di cucitura a punto metallico - stapling systems manufacturer

via Milano, 5 - 20007 Cornaredo (MI) - Italy

tel +39 02.93619.1 - fax +39 02.93619.222

[www.romeomaestri.com](http://www.romeomaestri.com) - [vendita@romeomaestri.it](mailto:vendita@romeomaestri.it)

