

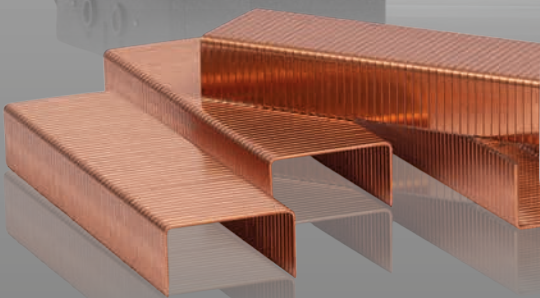

maestri[®]
Since 1919



 **CATALOGUE GÉNÉRAL**

-  **Fastening Line**
-  **Framing Line**
-  **Packaging Line**



*une histoire de Tradition
et d'Excellence*

Fastening Line



FIXEURS MANUELS EN MÉTAL

ROCAMA 10	4
ROCAMA JR 4.0	6
ROCAMA 14 4.0	8
ROCAMA 16	10
ROCAMA 20	12
M77 - M88	14

FIXEURS À MARTEAU

MART 13 - MART 50	15
-------------------	----

FIXEURS MANUELS EN PLASTIQUE

ROMA 10	16
ROMA 14	17
TECNICA 8	18
TECNICA 10	19
TECNICA 14	20
ROMATAK 10 4.0	22
ROMATAK 14 4.0	24



FIXEURS SANS FIL À PILES

ROCAMATICA	28
------------	----



FIXEURS ÉLECTRIQUES

ECOTAK	32
ELECTRO	34
LKT	36
ME	40

CLOUEUSES ÉLECTRIQUES

LKT 30	38
ME 30	42



OUTILS DE FIXATION PNEUMATIQUE

RO-MA 8016	46
RO-MA 8016BL	47
RO-MA 6414	48
RO-MA 8414	49
RO-MA 9240	50
RO-MA 9025	51
RO-MA 90 COMBI	52

CLOUEUSES PNEUMATIQUES

RO-MA 30TG	54
RO-MA 50TG	55
RO-MA 50 CONCRETE	56
RO-MA 55 MULTIBRAD	57
RO-MA 30/64	58
RO-MA 35/64	59
RO-MA 30/08	60
RO-MA 45/08	61

CLOUEUSES ÉLECTRIQUES À RUBAN

PN/2	62
------	----

Framing Line



CLOUEUSES MANUELLES POUR CADRES

F12	66
F18	68
F15 FLEX	70

CLOUEUSES PNEUMATIQUES POUR CADRES

FP12	67
FP18	69
FP15 FLEX	71

Packaging Line



AGRAFEUSES MANUELLES

ROAMA MANUAL	74
ELPABOX BH	76
GF135 MECCANICA	80

AGRAFEUSES PNEUMATIQUES

ROAMA PNEUMATIC	75
ELPABOX BA	77
RI-19/A	78
GF135 PNEUMATICA	81

APPAREILS SPÉCIAUX

RO-MA 73	79
----------	----



TENDEURS DE FEUILLARD MANUELS

MULTENS	84
B051	86
BAND-IT C001	88
FA/PLAST - MPL	90

TENDEUR DE FEUILLARD EN BATTERIE

TB 1216	92
TB 1620	93

PORTE-FEUILLARD

320 - M13-32	87
M4000 - PR/P	94

KIT D'EMBALLAGE

EASY PACK	95
-----------	----



COLLEUSES

MINIGRIP 7H	98
GRIP 11H	99
GRIP 15HL	100
GRIP 18HP	101
GRIP 20XP	102
M 195	103
M 220	104
M 3350	105
M 812	106
M812 MG	107
M12 / M7 / H12 / L12	108

Consumables

FASTENING	110
FRAMING	118
PACKAGING	119

ROCAMA 10	4
ROCAMA JR 4.0	6
ROCAMA 14 4.0	8
ROCAMA 16	10
ROCAMA 20	12
M77 - M88	14
MART 13 - MART 50	15
ROMA 10	16
ROMA 14	17
TECNICA 8	18
TECNICA 10	19
TECNICA 14	20
ROMATAK 10 4.0	22
ROMATAK 14 4.0	24





Corps en alliage spécial en aluminium. Chargement par le dessous du banc Poignée ergonomique. Assemblage de

châssis et cadres. Pour travaux de décoration. Pour fixer la tapisserie, les couvertures de canapés et de meubles. Idéal

pour tous les types de papier et d'étoffe, pour les aménagements des stands, l'ameublement des magasins, les intérieurs

Metal Black

Régulateur de puissance.



Raccord rapide pour la ceinture.



Disponibles en :



MADE in ITALY



CODE	ARTICLE		PACK
0104112	ROCAMA 10 METAL BLACK Mod. 107 S/A	Forest	5
0104110	ROCAMA 10 METAL BLACK Mod. 110 S/A	Forest-AP	5
0104113	ROCAMA 10 METAL BLACK Mod. 53 S/A	53/	5
0104111	ROCAMA 10 METAL BLACK Mod. 110/13 S/A	Forest-AP/13	5
> 0104310	ROCAMA 10 METAL BLACK Mod. 110 C/A	Forest-AP	5
> 0104311	ROCAMA 10 METAL BLACK Mod. 110/13 C/A	Forest-AP/13	5

> version avec annexe



des maisons, les roulottes, les caravanes.

ROCAMA 10 S/A (partie frontale sans bec)



Disponible en 4 modèles.

Mod. 107 S/A

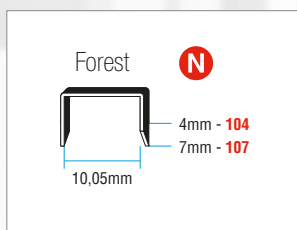

Mod.110 S/A

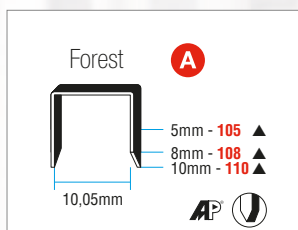

▲ Disponibles également en version AP

Mod. 53 S/A

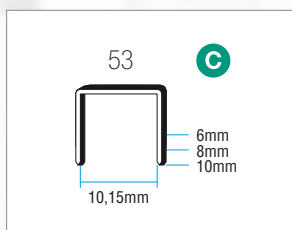

Mod. 110/13 S/A

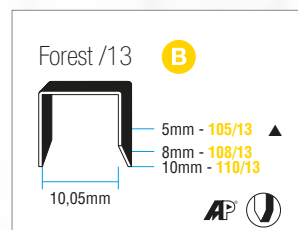

▲ Disponibles également en version AP

ROCAMA 10 C/A (partie frontale avec bec)



Disponible en 2 modèles.

Mod.110 C/A

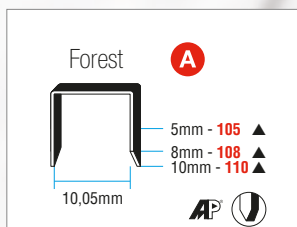

▲ Disponibles également en version AP

Mod. 110/13 C/A



▲ Disponibles également en version AP

FOREST® | **AP®** | **M53**

Il est conseillé d'utiliser des agrafes originales Maestri
Page 110, 111



110 mm



0,67

Compacte, maniable, robuste. Très puissante. Capacité maximale de fixation avec

un minimum d'efforts. Chargement depuis le bas. Assemblage châssis et cadres en bois.

Tapiserie, couverture de canapés et de meubles. Fixation de tous les types de papier et d'étoffe.

Metal Black

Poignée antiglisse.



4 en 1.

Quatre types différents d'agrafes et de clous métalliques sont utilisés, sans réglage nécessaire.

Bloc poignée.



Disponibles en :



CODE	ARTICLE					PACK
0101040	ROCAMA JR 4.0 Mod. 110	Forest-AP	53/	13/	M10	10
0101041	ROCAMA JR 4.0 Mod. 110/13	Forest-AP/13	50F/	53F/	M10	10

Disponibile en 2 modèles.

Mod. 110

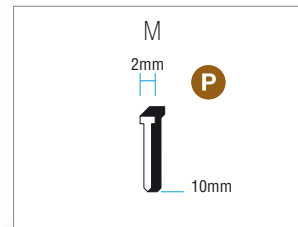
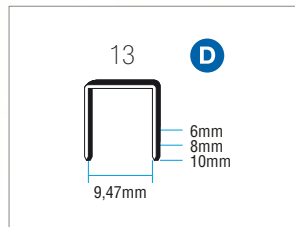
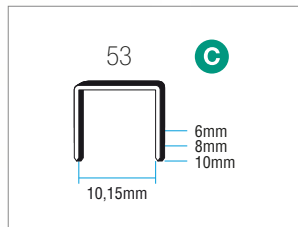
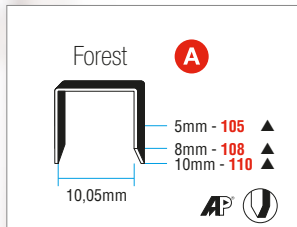

▲ Disponibles également en version AP

Mod. 110/13

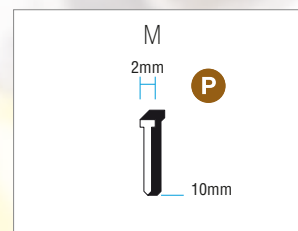
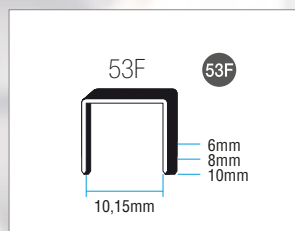
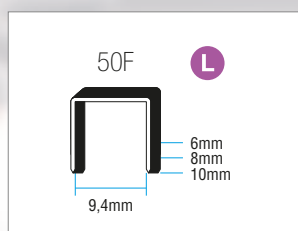
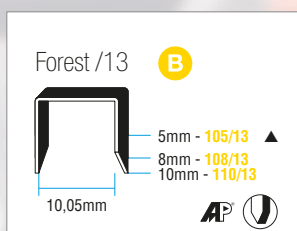

▲ Disponibles également en version AP

FOREST® AP M53 M50F M13 CHIODINI M

Il est conseillé d'utiliser des agrafes originales Maestri
 Page 110, 111, 112, 114

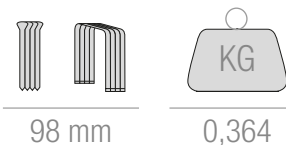

Assemblage de châssis et de meubles. Pour fixer pour tous des types de papier et d'étoffe, cadres, travaux de décoration. Pour fixer la tapisserie, les couvertures de canapés et de bois, pour les aménagements des stands, l'ameublement des magasins, les intérieurs des maisons, les roulottes, les caravanes.

Metal Black

Régulateur de puissance.



Poignée en caoutchouc antiglisse.



4 en 1.

Quatre types différents d'agrafes et de clous métalliques sont utilisés, sans réglage nécessaire.

Bloc poignée.



Disponibles en :



CODE	ARTICLE					PACK
0104530	ROCAMA 14 4.0 Mod. 114	AP-Forest	53/	13/	M15	5



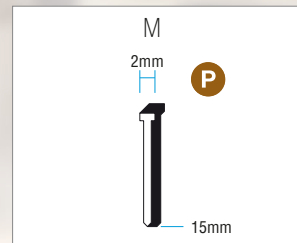
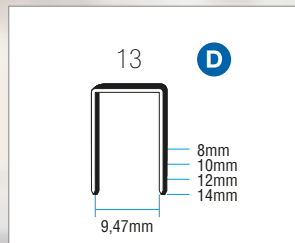
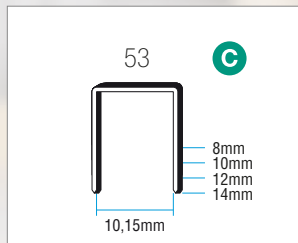
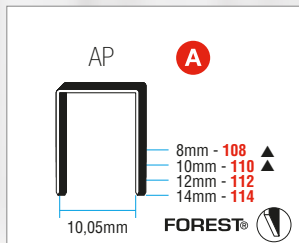

▲ Disponibles également en version FOREST

FOREST® **AP** M53 M13 CHIODINI M

Il est conseillé d'utiliser des agrafes originales Maestri
Page 110, 111, 114

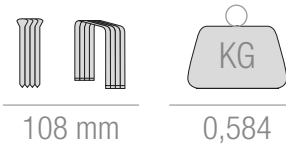

Compacte, maniable, robuste. Très puissante. Capacité maximale de fixation avec un minimum

d'efforts. Travaux de décoration, de tapisserie, de menuiserie, de fixation d'isolants, de lames de bois,

de panneaux en bois, de couvre-fils, de plinthes, etc. Pour fixer de tous les types de papier et d'étoffe.

Metal Black

Régulateur de puissance.



Partie frontale amovible.

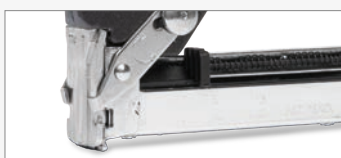

3 en 1.

Trois types différents d'agrafes et de clous métalliques sont utilisés, sans réglage nécessaire.

Bloc poignée.



Disponibles en :



CODE	ARTICLE				PACK
0105001	ROCAMA 16 METAL BLACK Mod. 116B	AP-Forest	M13-15	W15	5
0105003	ROCAMA 16 METAL BLACK Mod. 53.16B	53/	M13-15	W15	5
0105005	ROCAMA 16 METAL BLACK Mod. 13.14	13/			5
0105225	ROCAMA 16 METAL BLACK Mod. 80.16	80/			5
> 0105004	ROCAMA 16 METAL BLACK Mod. 50F	50F/			5
> 0105210	ROCAMA 16 METAL BLACK Mod. 71	C800 (C) 3G - 71			5
> 0105232	ROCAMA 16 METAL BLACK Mod. 54	54/			5
> 0105227	ROCAMA 16 METAL BLACK Mod. 34	34/			5
> 0105229	ROCAMA 16 METAL BLACK Mod. 50	50/			5
> 0105214	ROCAMA 16 METAL BLACK OUTWARD CLINCH	ST50/			5
> 0105216	ROCAMA 16 METAL BLACK Mod. ST.50	ST50/			5

> version spéciale sur demande

 MADE in ITALY



Disponible en 11 modèles.

Mod. 116B

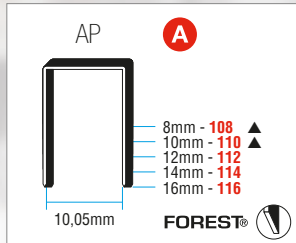

▲ Disponibles également en version FOREST

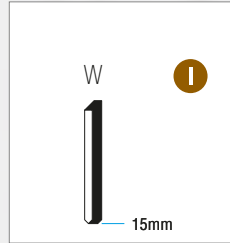
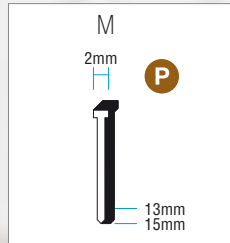

Mod. 53.16B

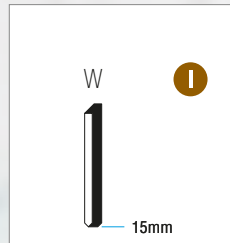
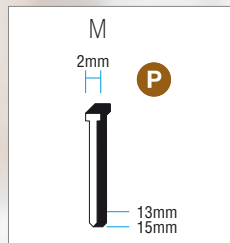
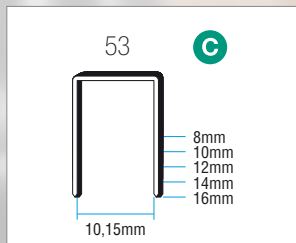

Mod. 13.14

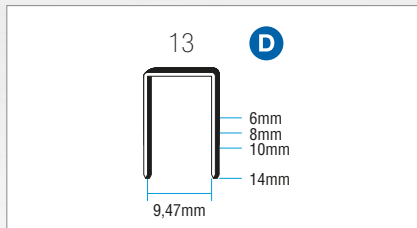

Mod. 80.16

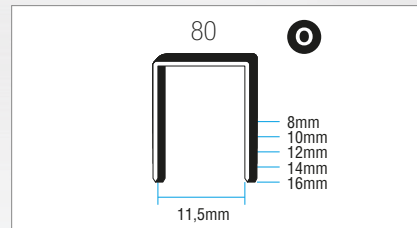

Mod. 50F

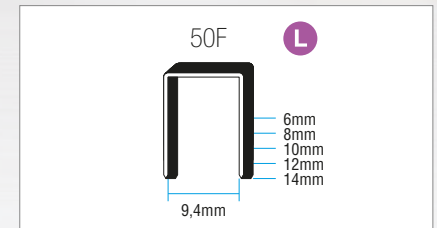

Mod. 71

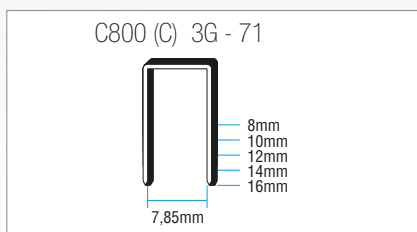

Mod. 54

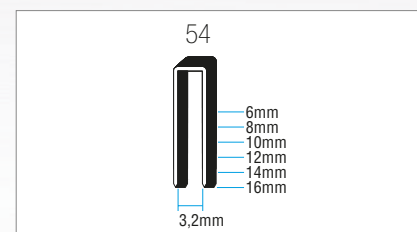

Mod. 34

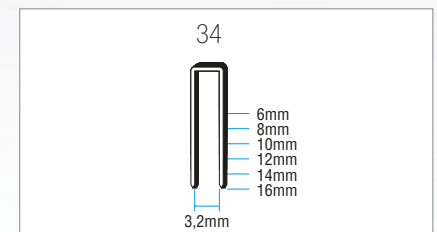

Mod. 50

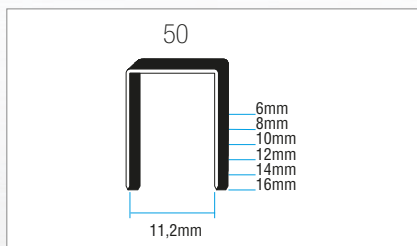

Mod. ST50

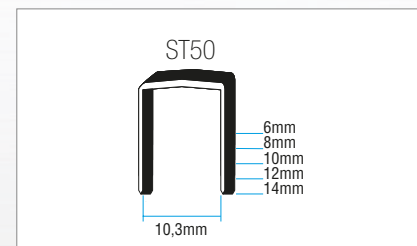

Mod. OUTWARD CLINCH

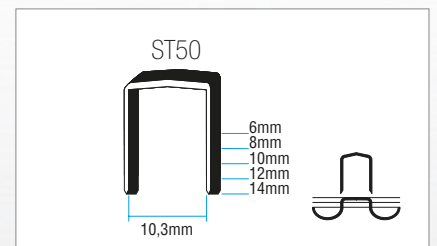

FOREST® AP M53 M50F M13 80 CHIODINI W-M

Il est conseillé d'utiliser des agrafes originales Maestri
Page 110, 111, 112, 113, 114



130 mm



0,68

Compacte, maniable, robuste. Très puissante. Capacité maximale de fixation avec un minimum

d'efforts. Travaux de décoration, de tapisserie, de menuiserie, de fixation d'isolants, de lames de bois,

de panneaux en bois, de couvre-fils, de plinthes, etc. Pour fixer de tous les types de papier et d'étoffe.

Metal Black

Régulateur de puissance.



Partie frontale amovible.

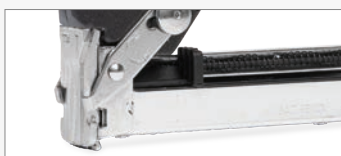

3 en 1.

Trois types différents d'agrafes et de clous métalliques sont utilisés, sans réglage nécessaire.

Bloc poignée.



Disponibles en :



CODE	ARTICLE				PACK
0105503	ROCAMA 20 METAL BLACK Mod. 120B	AP-Forest	M20	W20	5
0105501	ROCAMA 20 METAL BLACK Mod. 53/20B	53/	M20	W20	5

 MADE in ITALY



Disponibile en 2 modèles.

Mod. 120B

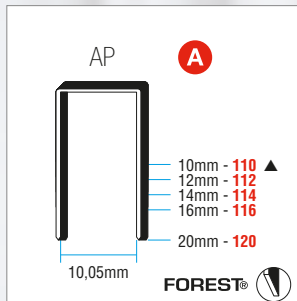

▲ Disponibles également en version FOREST

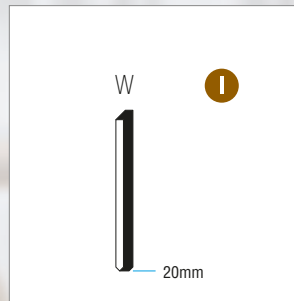
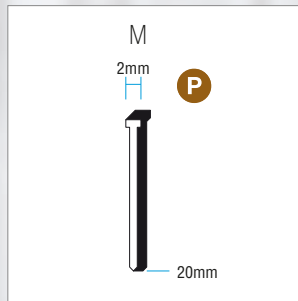

Mod. 53/20B

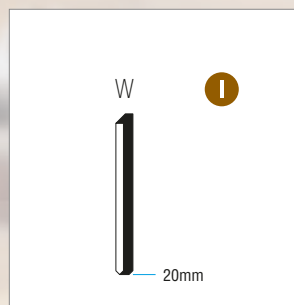
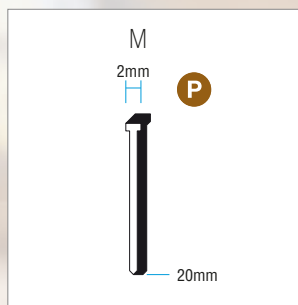
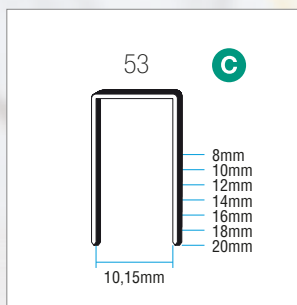

FOREST® **AP®** **M53 CHIODINI W-M**

Il est conseillé d'utiliser des agrafes originales Maestri
Page 110, 111, 114

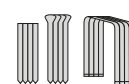

130 mm



0,69

M77 - M88

Fixeur manuel en acier chromé avec poignée revêtue en plastique isolant.

Idéal pour fixer des câbles télévisuels et téléphoniques Ø 5 mm (M77) et Ø 6,5 mm (M88).

Poignée anatomique en caoutchouc.



Bloc poignée.



Disponibles en :



CODE	ARTICLE		PACK
0121301	M 77	77/	4
0121302	M 88	88/	4



Disponible en 2 modèles.
Mod. M 77 Mod. M 88

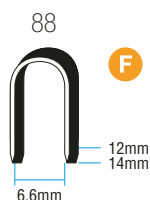
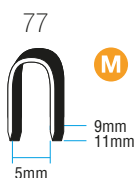

77/ 88/

Il est conseillé d'utiliser des agrafes originales Maestri
Page 112

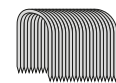

120 mm



KG

0,85

FIXEURS À MARTEAU



Fixeur à marteau d'isolation, de couverture, de papier goudronné, pour agrafes métalliques, étudié pour être utilisé d'étiquettes sur les caisses, de pour fixer des matériaux filets et de caisses pour les fruits.

MART 13 MART 50

CODE	ARTICLE		PACK
0190162	MART 13	13/	6
0190160	MART 50	50F/	4



Mod. MART 13

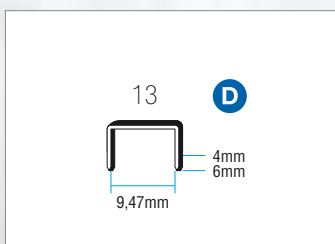

Disponibles en :

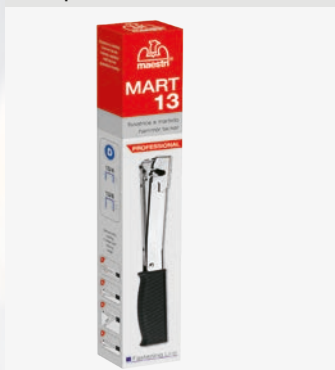

Mod. MART 50

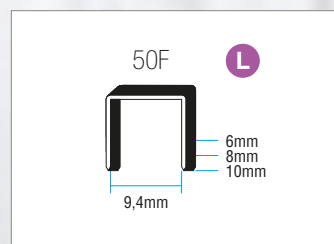

Disponibles en :



M13

Il est conseillé d'utiliser des agrafes originales Maestri
Page 111



124 mm



KG

0,40

M50F

Il est conseillé d'utiliser des agrafes originales Maestri
Page 111



210 mm



KG

0,98

Pour travaux de décoration.
Pour fixer la tapisserie, les
couvertures de canapés et
de meubles.

Pour fixer de tous les
types de papier et d'étoffe.
Revêtir des chaises et
décorer des vitrines.

Ameublement de magasins.
Chargement par le dessous
du banc.

Corps en ABS.



Bloc poignée.



Disponibles en :



CODE	ARTICLE		PACK
0112025	ROMA 10	53/	8

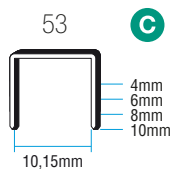

M53

Il est conseillé d'utiliser des agrafes originales Maestri
Page 111



80 mm

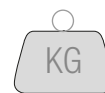

0,25

ROMA 14

Pour travaux de décoration. Pour fixer la tapisserie, les couvertures de canapés et de meubles. Pour fixer de tous les types de papier et d'étoffe. Revêtir des chaises et décorer des vitrines. Fixation de plinthes, de profils en bois, de panneaux.

Poignée pratique et ergonomique. Chargement par le dessous du banc. Bloc poignée.

CODE	ARTICLE			PACK
0114023	ROMA 14	53/	M15	8

Corps en ABS.



Régulateur de puissance.



Disponibles en :

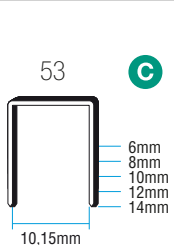

M53 CHIODINI M

Il est conseillé d'utiliser des agrafes originales Maestri
Page 111, 114

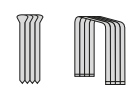

105 mm



0,42

Pour les travaux de décorations et de fixation de tapisserie, de couvertures de canapés et

de meubles. Pour fixer de tous les types de papier et d'étoffe, recouvrir des chaises et décorer des

vitrines.
Chargement depuis le bas.

Corps en ABS antichoc 20 % fibres en verre et devant en acier.



Bloc poignée.



Disponibles en :



CODE	ARTICLE		PACK
0112010	TECNICA 8 Mod. 108	Forest-AP	10

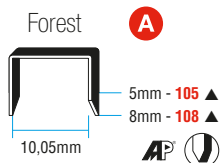

▲ Disponibles également en version AP

FOREST® | **AP®**

Il est conseillé d'utiliser des agrafes originales Maestri
Page 110, 111



80 mm



KG

0,33

CODE	ARTICLE		PACK
0113086	TECNICA 10 Mod. 110	Forest-AP	10
0113087	TECNICA 10 Mod. 110/13	Forest-AP/13	10

Corps en ABS antichoc 20 % fibres en verre et devant en acier.



Bloc poignée.



Disponibles en :



Disponible en 2 modèles.

Mod. 110

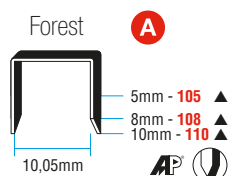

▲ Disponibles également en version AP

Mod. 110/13

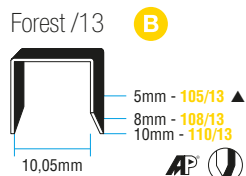

▲ Disponibles également en version AP

FOREST® **AP®**

Il est conseillé d'utiliser des agrafes originales Maestri
Page 110, 111



100 mm



0,43

*Pour travaux de décoration.
Fixation de tapisserie.
Pour fixer de tous les types
de papier et d'étoffe.*

*Revêtir des chaises et
décorer des vitrines.
Fixation de plinthes,
de profils en bois, de*

*panneaux.
Chargement par le dessous
du banc.*

Corps en nylon antichoc 30 %
fibres de verre.



Régulateur de puissance.



Bloc poignée.

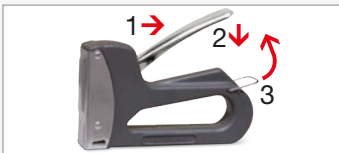

Disponibles en :



CODE	ARTICLE			PACK
0114002	TECNICA 14 Mod. 114	AP-Forest	M15	10
0114003	TECNICA 14 Mod. 53.14	53/	M15	10



Disponibile en 2 modèles.

Mod. 114

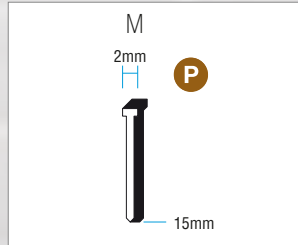
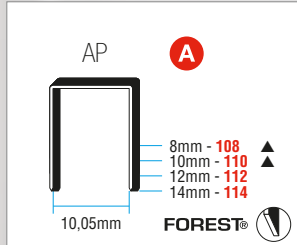

▲ Disponibles également en version FOREST

Mod. 53.14

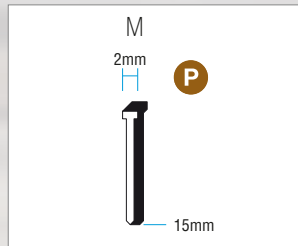
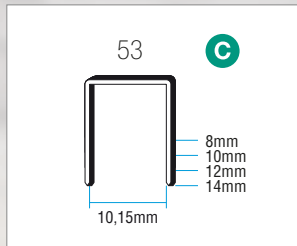

FOREST® AP® M53 CHIODINI M

Il est conseillé d'utiliser des agrafes originales Maestri
Page 110, 111, 114

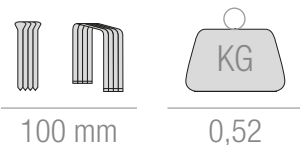

Compacte, maniable, robuste. Très puissante. Capacité maximale de fixation avec un minimum

d'efforts. Assemblage châssis et cadres en bois. Travaux de décorations et fixation de tapisserie,

revêtement de canapés et de meubles. Fixation de tous les types de papier et d'étoffe.

4 en 1.

Quatre types différents d'agrafes et de clous métalliques sont utilisés, sans réglage nécessaire.

Corps en nylon
30 % fibres de verre.



Bloc poignée.



Disponibles en :



CODE	ARTICLE					PACK
0113095	ROMATAK 10 4.0 Mod. 110	Forest-AP	53/	13/	M10	10
0113096	ROMATAK 10 4.0 Mod. 110/13	Forest-AP/13	50F/	53F/	M10	10



Disponible en 2 modèles.

Mod. 110

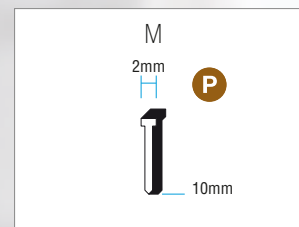
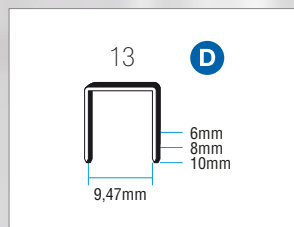
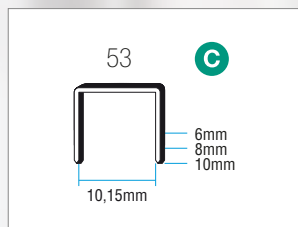
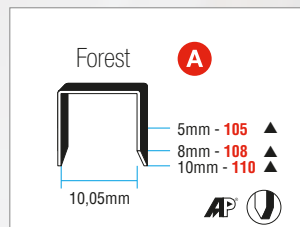

▲ Disponibles également en version AP

Mod. 110/13

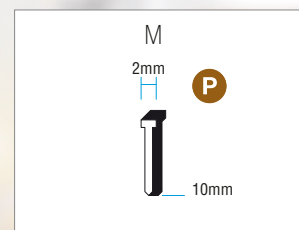
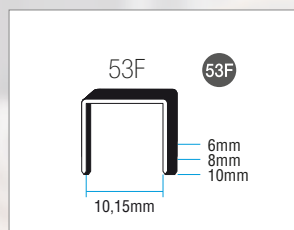
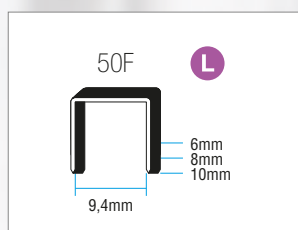
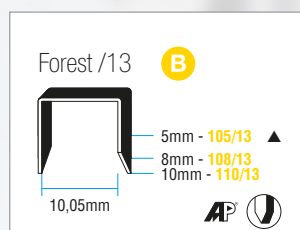

▲ Disponibles également en version AP

FOREST® | **AP®** | **M53** | **M50F** | **M13** | **CHIODINI M**

Il est conseillé d'utiliser des agrafes originales Maestri
Page 110, 111, 112, 114



98 mm



0,248

Compacte, maniable, robuste. Très puissante. Capacité maximale de fixation avec un minimum

d'efforts. Assemblage châssis et cadres en bois. Travaux de décorations et fixation de tapisserie,

revêtement de canapés et de meubles. Fixation de tous les types de papier et d'étoffe.

4 en 1.

Quatre types différents d'agrafes et de clous métalliques sont utilisés, sans réglage nécessaire.

Régulateur de puissance.



Bloc poignée.



Disponibles en :



CODE	ARTICLE					PACK
0114011	ROMATAK 14 4.0 Mod. 114	AP-Forest	53/	13/	M15	10



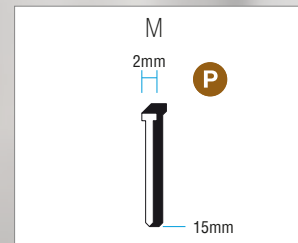
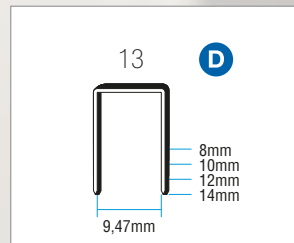
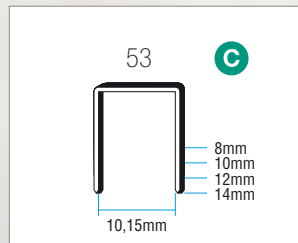
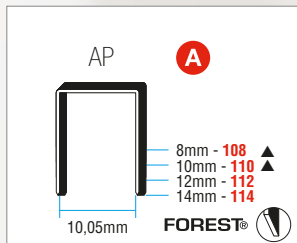

▲ Disponibles également en version FOREST

FOREST® | **AP®** | **M53** | **M13** | **CHIODINI M**

Il est conseillé d'utiliser des agrafes originales Maestri
Page 110, 111, 114

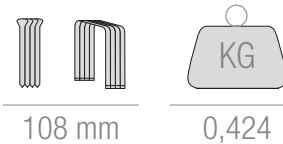





FIXEURS SANS FIL À PILES

Fixeur sans fil léger et compact. Conçu avec une batterie rechargeable de technologie lithium, intégrée

dans le corps, qui garantit une longue durée de vie du produit. Coque en plastique réalisée en technopolymère

haute résistance. Bouton chariot pratique pour un chargement rapide et facile sous le comptoir. Idéal



3.7V
Li-ION BATTERY
TECHNOLOGY

Manche en caoutchouc antiglisse et régulateur de puissance.



Gâchette de sécurité.



Éclairage de travail à LED.



Caractéristiques :

Niveau sonore: LwA 80,1 dBA
LpA 69,1 dBA

Niveau de vibration: 1,018 m/s²

Disponibles en :



comprend :

- ▶ 5.000 agrafes 108 Forest
- ▶ 1 Chargeur de batterie
- ▶ 1 Câble de recharge
- ▶ 1 Lunettes de protection

Conforme aux directives :

- ▶ ROHS
- ▶ 2006/42/CE



CODE	ARTICLE			PACK
0130001	ROCAMATICA Mod. 114	AP-Forest	M15	1



pour le bricolage et tous les travaux de fixation : décoration, assemblage de cadres et de châssis,

tapiserie, revêtement de meubles et de canapés, installation d'isolants, aménagement de stands de

foire, pour les intérieurs de caravanes, de camping-cars et de bateaux.

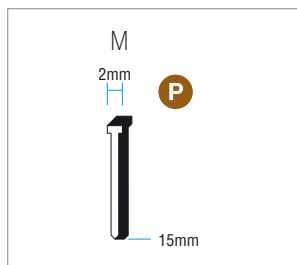
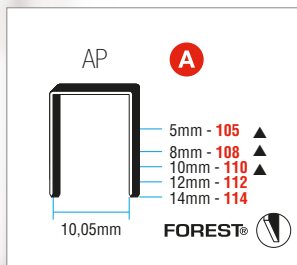

▲ Disponibles également en version FOREST



FOREST® **AP®** **CHIODINI M**

Il est conseillé d'utiliser des agrafes originales Maestri
Page 110, 111, 114



110 mm



BATTERIE
AU LITHIUM
3,7V 2000mAh



1,05

ECOTAK	32
ELECTRO	34
LKT	36
LKT 30	38
ME	40
ME 30	42





Rapide, légère, robuste, électronique d'avant-garde, système de sécurité breveté.

Manche adaptable à des utilisations différentes. Pour l'assemblage de châssis et cadres.

Travaux de décoration. Pour fixer la tapisserie, les revêtements de canapés et de meubles.

Hi-Tech ELECTRONIC

Corps en technopolymère.



Caractéristiques :

Niveau sonore : LpA 73,9 dBA
LwA 85 dBA

Niveau de vibration : 5,17 m/s²

Disponibles en :



Conforme aux directives :

- ▶ ROHS
- ▶ 2006/42/CE



CODE	ARTICLE				PACK
0140301	ECOTAK Mod. 114 B	AP-Forest	M15	W15	1
0140001	ECOTAK Mod. 53.14 B	53/	M15	W15	1

MADE in ITALY



Installations d'isollements. caravanes, nautique.
 Aménagement de stands et
 ameublements magasins.
 Intérieurs roulottes,

Disponible en 2 modèles.

Mod. 114B

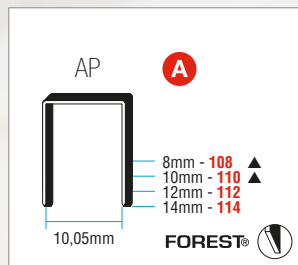

▲ Disponibles également en version FOREST

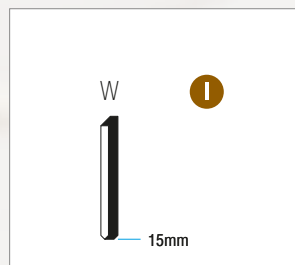
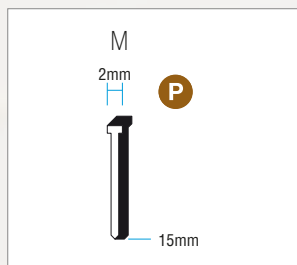

Mod. 53.14B

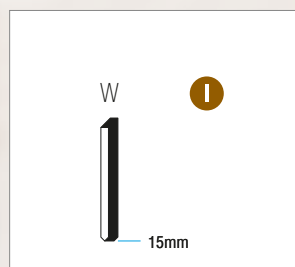
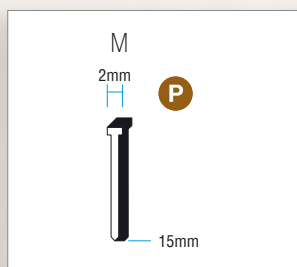
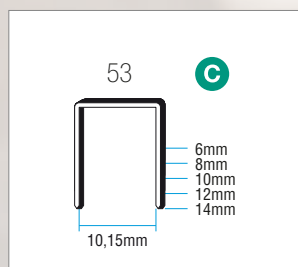

Câble électrique 2,5 m / 98" fourni avec une fiche électrique au choix :



FOREST® **AP®** **M53** **CHIODINI W-M**

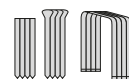

110 mm



AC220/240V
50-60 Hz

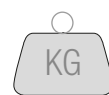

0,83

Il est conseillé d'utiliser des agrafes originales Maestri
 Page 110, 111, 114

Rapide, léger, robuste.
Coque en technopolymère
haute résistance. Équipé
d'un interrupteur marche/

arrêt et d'un bouton de
réglage de la puissance.
Chargement sous le banc
de travail. Idéal pour toutes

les applications de fixation
telles que les décorations,
les garnitures de stand,
les assemblages de

Hi-Tech ELECTRONIC

Palpeur de sécurité.



Manche en caoutchouc
antiglisse.



Poignée de réglage de la
puissance.



Caractéristiques:

Niveau sonore: LwA 95,8 dBA
LpA 84,8 dBA

Niveau de vibration: 2,929 m/s²

Disponibles en :



Conforme aux directives :

- ▶ ROHS
- ▶ 2006/42/CE



CODE	ARTICLE			PACK
0140404	ELECTRO 53.14	53/	M15	1



cadres, les fixations et les rembourrages. Intérieur des caravanes, camping-cars, bateaux.

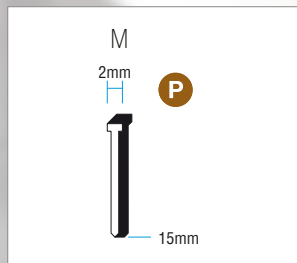
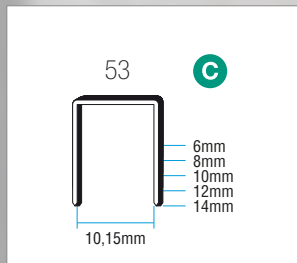

M53 CHIODINI M

Il est conseillé d'utiliser des agrafes originales Maestri
Page 111, 114



110 mm



AC220/240V
50 Hz



0,650

Légère, rapide, puissante.
Assemblage de châssis
et cadres. Travaux de
décoration. Tapisserie,

revêtement de canapés et
de meubles. Installations
d'isolations. Aménagements
de stands et ameublement

magasins. Intérieurs
roulottes, caravanes,
nautique. Chargement par
l'arrière avec pousseur

Extreme PROFESSIONAL

Gâchette de sécurité et
partie frontale amovible.



Manche en caoutchouc
antiglisse.



Corps en nylon 30 % fibres
de verre à haute résistance.



Caractéristiques :

Niveau sonore : LwA 91,5 dBA
LpA 80,7 dBA

Niveau de vibration : 4,96 m/s²

Disponibles en :



Conforme aux directives :

- ▶ ROHS
- ▶ 2006/42/CE



CODE	ARTICLE			PACK
0141232	LKT Mod. 120	AP-Forest	AP19	1
0141234	LKT Mod. 53	53/	AP19	1
0141236	LKT Mod. 80 Brad	80/	AP19	1
0141238	LKT Mod. 13	13/		1
0141242	LKT Mod. 50F	50F/		1
0141240	LKT Mod. 4/606 COMBI	606/	AP 15-19-25	1

MADE in ITALY



d'agrafe incorporé. Sécurité aucune empreinte d'appui.
 contre le tir accidentel.
 Étudié pour opérer sur des
 produits finis. Ne laisse

Disponible en 6 modèles.

Mod. 120

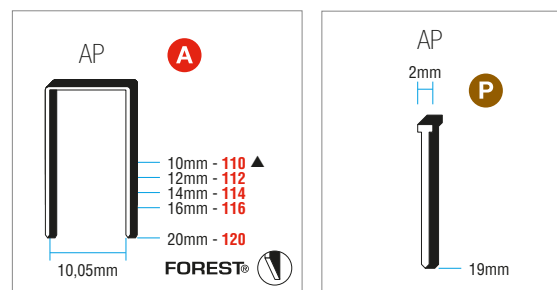

▲ Disponibles également en version FOREST

Mod. 53

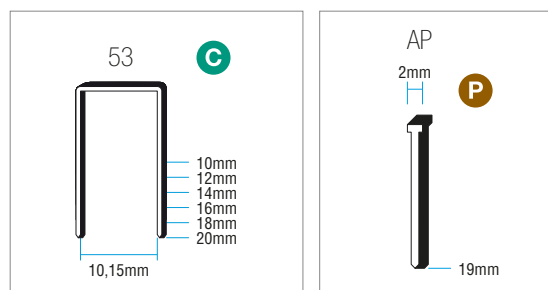

Mod. 80 Brad

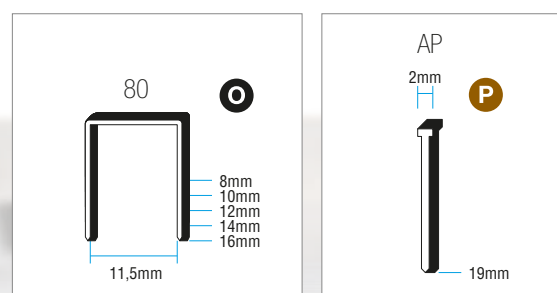

Mod. 13

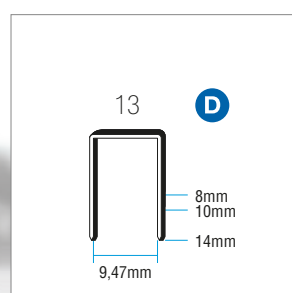

Mod. 4/606 COMBI

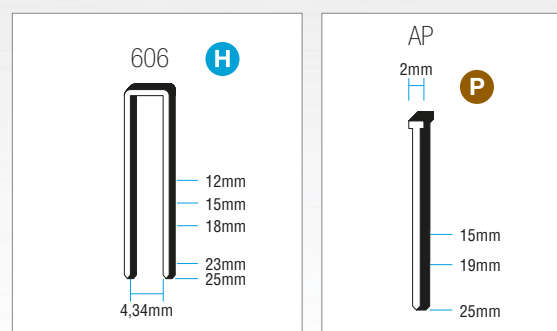

Mod. 50F

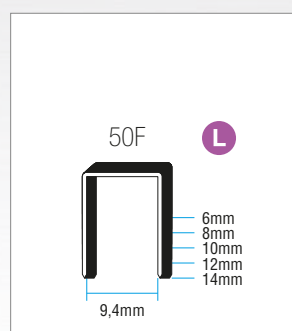

Câble électrique 3,5 m / 138" fourni avec une fiche électrique au choix :



FOREST® AP® M53 80 M13 M50F 606

Il est conseillé d'utiliser des agrafes originales Maestri
 Page 110, 111, 112, 113, 114

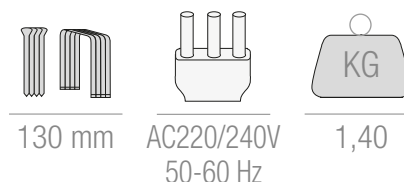

130 mm

AC220/240V
 50-60 Hz

1,40

Légère, rapide, puissante.
Étudié spécifiquement pour
opérer sur des produits
finis sans laisser aucune

empreinte d'appui. Spécial
pour les monteurs de
cadres, de profils de portes
et de fenêtres, de lames en

bois, etc.
Pour les bois tendres et
durs.

Extreme PROFESSIONAL

Gâchette de sécurité et
partie frontale amovible.



Manche en caoutchouc
antiglisser.



Corps en nylon 30% fibres
de verre à haute résistance.



Caractéristiques :

Niveau sonore: LpA 82,9 dBA
LwA 94 dBA

Niveau de vibration: 4,92 m/s²

Disponibles en :



Conforme aux directives :

- ▶ ROHS
- ▶ 2006/42/CE



CODE	ARTICLE	PACK
0145110	LKT 30	AP 15-19-25-30 1

MADE in ITALY



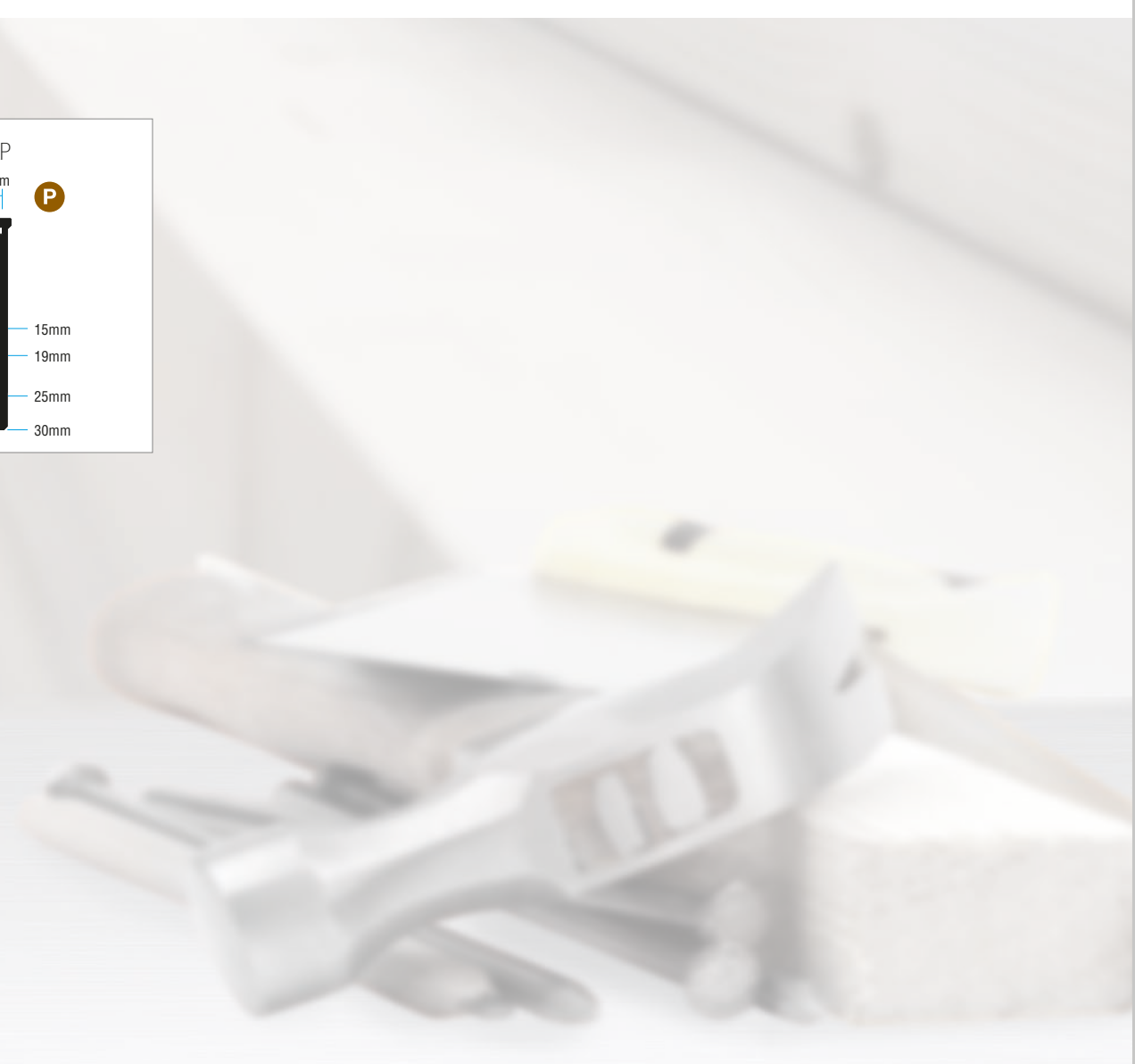
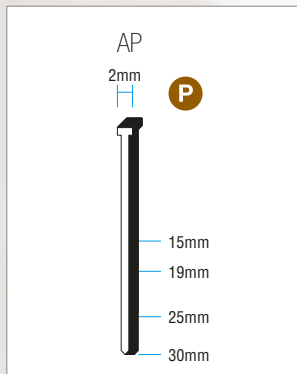

Câble électrique 3,5 m / 138" fourni avec une fiche électrique au choix :



Il est conseillé d'utiliser des agrafes originales Maestri
Page 114



130 mm



AC220/240V
50-60 Hz

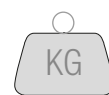

1,40

Équipement professionnel idéal pour l'assemblage de châssis, de cadres et de tapisserie murale.

Travaux de décoration et de réparations de meubles. Fixation de cadres sur les meubles et les

serrures, de couvre-fils et de lames en bois. Aménagement de stands, ameublements magasins.

Extreme PROFESSIONAL

Gâchette de sécurité et partie frontale amovible.



Corps en nylon 30 % fibres de verre à haute résistance.



Caractéristiques :

Niveau sonore : LwA 91,5 dBA
LpA 80,7 dBA

Niveau de vibration : 4,96 m/s²

Disponibles en :



Conforme aux directives :

- ▶ ROHS
- ▶ 2006/42/CE



CODE	ARTICLE			PACK
0211113	ME80	80/		1
0211150	ME80 BRAD	80/	AP19	1
0211130	ME4000	4000/		1
0212110	ME 606	606/	AP 15-19-25	1
0211114	ME80 - 110V	80/		1
0213305	ME3G - 110V	C800 (C) 3G - 71		1
0211140	ME54 - 110V	54/		1
0141011	ME50F - 110V	50F/		1
0211136	ME50 - 110V	50/		1

MADE in ITALY



Disponible en 8 modèles.

Mod. 80

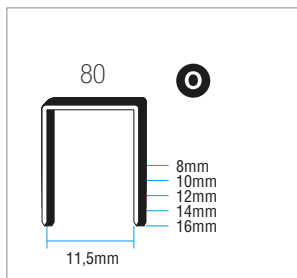

Mod. 50F

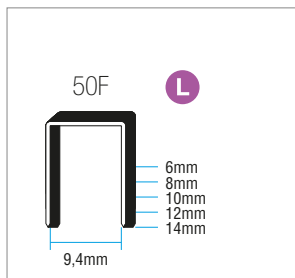

Mod. 4000

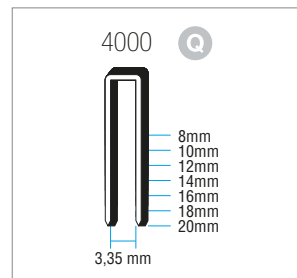

Mod. 80 Brad

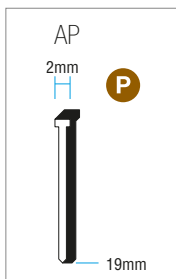
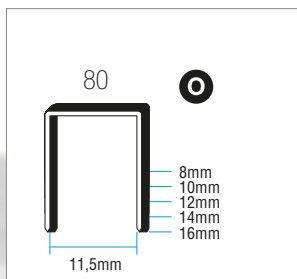

Mod. 3G

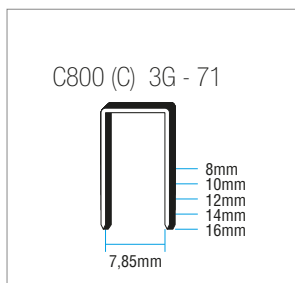

Mod. 54

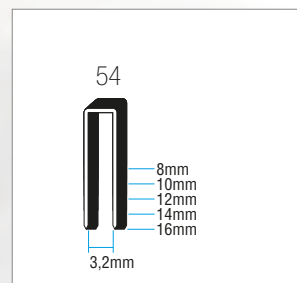

Mod. 606

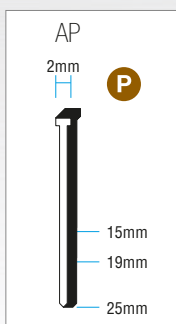
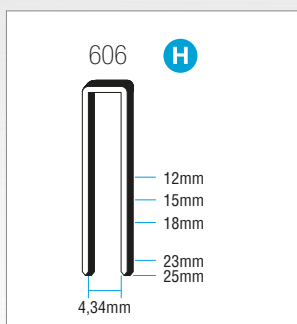

Mod. 50

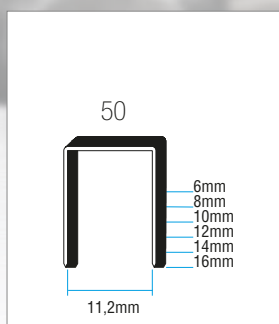

Mod. 33

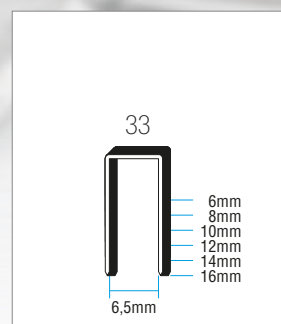

Câble électrique 3,5 m / 138" fourni avec une fiche électrique au choix :



AP 80 M50F 606 4000 C800

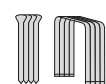

130 mm



AC110/120V
AC220/240V
50-60 Hz



1,40

Il est conseillé d'utiliser des agrafes originales Maestri
Page 111, 112, 113, 114

Étudiée pour opérer sur des produits finis sans laisser aucune empreinte d'appui. Spéciale pour les monteurs

de cadres, de profils de portes et de fenêtres, de lames de bois, etc. et pour tous les poseurs en

tout genre : elle travaille indifféremment sur des bois tendres ou durs, en sous-niveau.

Extreme PROFESSIONAL

Gâchette de sécurité et partie frontale amovible.



Corps en nylon 30% fibres de verre à haute résistance.



Caractéristiques :

Niveau sonore : LpA 82,9 dBA
LwA 94 dBA

Niveau de vibration : 4,92 m/s²

Disponibles en :



Conforme aux directives :

- ▶ ROHS
- ▶ 2006/42/CE



CODE	ARTICLE	PACK
0215121	ME30	AP 15-19-25-30 1

MADE in ITALY



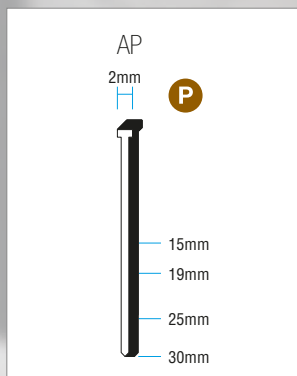

Câble électrique 3,5 m / 138" fourni avec une fiche électrique au choix :



Il est conseillé d'utiliser des agrafes originales Maestri
Page 114



130 mm



AC110/120V
AC220/240V
50-60 Hz



KG

1,40

RO-MA 8016	46
RO-MA 8016BL	47
RO-MA 6414	48
RO-MA 8414	49
RO-MA 9240	50
RO-MA 9025	51
RO-MA 90 COMBI	52
RO-MA 30TG	54
RO-MA 50TG	55
RO-MA 50 CONCRETE	56
RO-MA 55 MULTIBRAD	57
RO-MA 30/64	58
RO-MA 35/64	59
RO-MA 30/08	60
RO-MA 45/08	61
PN/2	62





OUTILS DE FIXATION PNEUMATIQUES POUR AGRAFES LÉGÈRES

*Puissants, légers,
compacts. Parfaits pour
la tapisserie murale.
Revêtement*

*fauteuils et canapés.
Travaux de décoration.
Installation d'isolations
thermiques et acoustiques.*

*Intérieurs roulottes,
caravane, nautique.
Chargement par le dessous
du banc.*

Manche en caoutchouc.



Caractéristiques :

Consommation en air
à 60 cycles/min : 51 l/min

Niveau sonore : LwA 96,4 dBA

Niveau de vibration : 1,9 m/s²

Disponibles en :



Conforme
aux directives :

► 2006/42/CE



CODE	ARTICLE		PACK
0153143	RO-MA 8016 RED LINE	80/	1

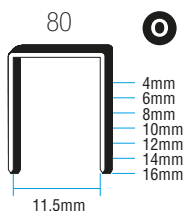

80

Il est conseillé d'utiliser des agrafes originales Maestri
Page 112



130 mm

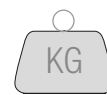

1



4/8

RO-MA 8016 BL

CODE	ARTICLE		PACK
0231522	RO-MA 8016 BL	80/	1

Manche en caoutchouc.



Gâchette de sécurité.



Caractéristiques :

Consommation en air
à 60 cycles/min : 31,6 l/min
à 6,2bar (10psi)

Niveau sonore : LwA 90 dBA

Niveau de vibration : 0,7 m/s²

Disponibles en :



Conforme
aux directives :

► 2006/42/CE



◀ La partie frontale longue et fine permet d'y accéder facilement sans empêcher la visibilité sur les surfaces de travail difficiles à atteindre.

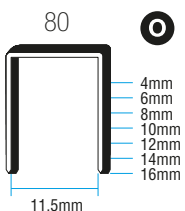

80

Il est conseillé d'utiliser des agrafes originales Maestri
Page 112



130 mm

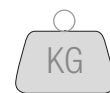

1



6/7

OUTILS DE FIXATION PNEUMATIQUES POUR AGRAFES LÉGÈRES

*Puissants, légers,
compacts. Parfaits pour
la tapisserie murale.
Revêtement*

*fauteuils et canapés.
Travaux de décoration.
Installation d'isolations
thermiques et acoustiques.*

*Intérieurs roulottes,
caravane, nautique.
Chargement par le dessous
du banc.*

Manche en caoutchouc.



Caractéristiques :

Consommation en air
à 60 cycles/min : 85l/min
à 6,2 bar (10psi)

Niveau sonore : LpA 88 dBA

Niveau de vibration : 2,5 m/s²

Disponibles en :



Conforme
aux directives :

► 2006/42/CE



CODE	ARTICLE	PACK	
0153145	RO-MA 6414	64/	1

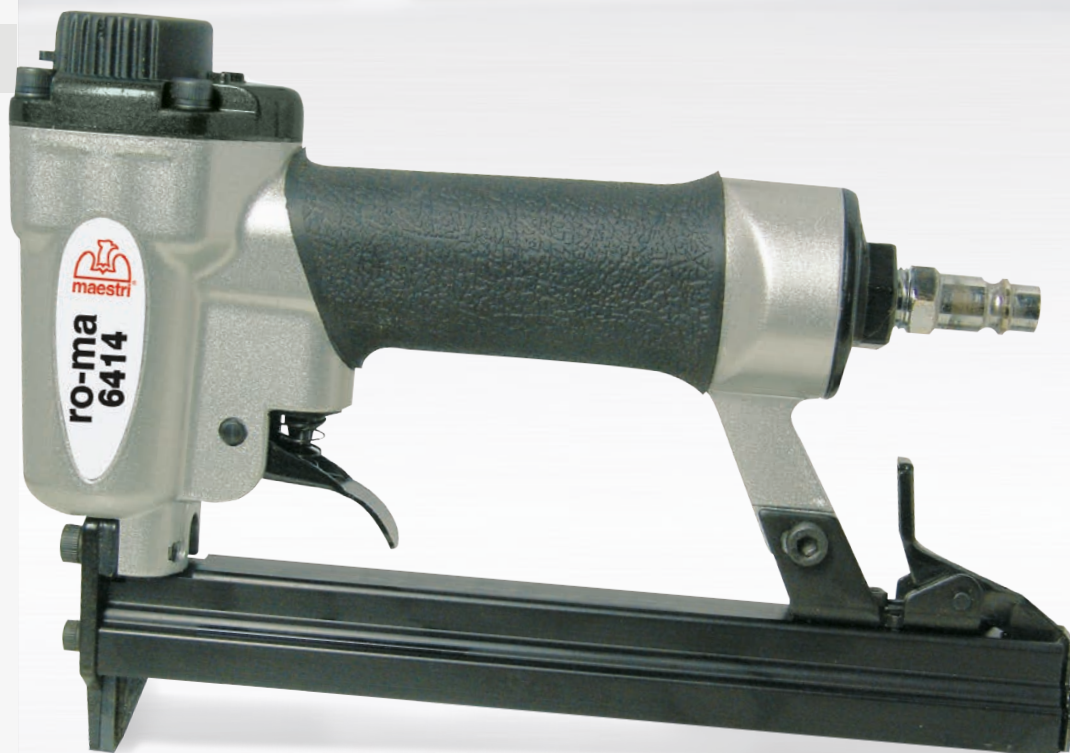

64

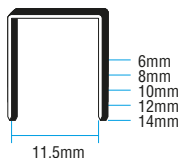

64

Il est conseillé d'utiliser des agrafes originales Maestri
Page 112



150 mm



KG

0,90



ATM

4/7

RO-MA 8414

CODE	ARTICLE	PACK	
0153147	RO-MA 8414	84/	1

Manche en caoutchouc.



Caractéristiques :

Consommation en air
à 60 cycles/min : 85 l/min
à 6,2 bar (10psi)

Niveau sonore : LwA 88 dBA

Niveau de vibration : 2,5 m/s²

Disponibles en :



Conforme
aux directives :

► 2006/42/CE

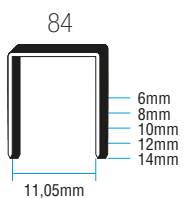
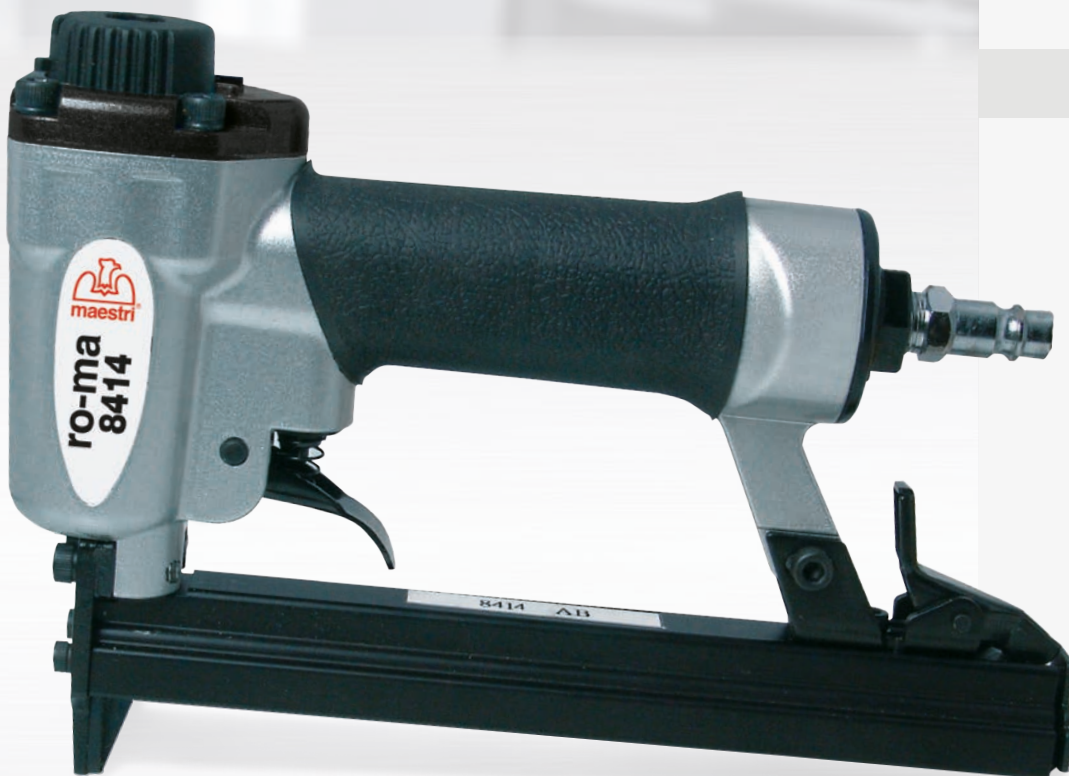

84

Il est conseillé d'utiliser des agrafes originales Maestri
Page 112



130 mm



0,90



4/7

OUTILS DE FIXATION PNEUMATIQUES POUR AGRAFES MOYENNES

*Puissant, léger, compact.
Pour les laboratoires
artisans, de menuiserie
et de charpenterie.*

*Assemblage de châssis et
cadres. Chargement par le
dessous du banc.
Déflecteur d'air directionnel.*

Manche en caoutchouc.



Caractéristiques :

Consommation en air
à 60 cycles/min : 56,6 l/min
à 6,2 bar (10psi)

Niveau sonore : LpA 89,5 dBA

Niveau de vibration : < 2,5 m/s²

Disponibles en :



Conforme
aux directives :

► 2006/42/CE



CODE	ARTICLE	PACK	
0153115	RO-MA 9240	92/	1



92/

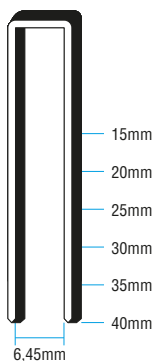

92

Il est conseillé d'utiliser des agrafes originales Maestri
Page 113



150 mm

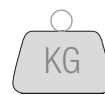

1,45



ATM

4,5/7

Puissant, léger, compact.
Idéale pour la tapisserie
murale. Revêtement
fauteuils et canapés.

Travaux de décoration.
Installation d'isolations
thermiques et acoustiques.
Intérieurs roulottes,

caravane, nautique.
Chargement par le dessous
du banc.

RO-MA 9025

CODE	ARTICLE		PACK
0153155	RO-MA 9025	90/	1



Manche en caoutchouc.



Caractéristiques :

Consommation en air
à 60 cycles/min : 85 l/min
à 6,2 bar

Niveau sonore : LpA 90 dBA

Niveau de vibration : 2,7 m/s²

Disponibles en :



Conforme
aux directives :

► 2006/42/CE

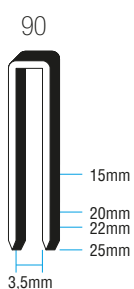

90

Il est conseillé d'utiliser des agrafes originales Maestri
Page 113



140 mm

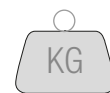

1



ATM

4/7

Puissant, léger, compact. Aménagements de stands et ameublements magasins. profilés sur bois pour serrures et cadres. Lames en bois internes et externes. Charge latérale (clous) et depuis le dessus (agrafes métalliques). Déflecteur d'air directionnel.

RO-MA 90 COMBI

Manche en caoutchouc.



Caractéristiques :

Consommation en air à 60 cycles/min: 67 l/min

Niveau sonore : LwA 97,1 dBA

Niveau de vibration : 3,8 m/s²

Disponibles en :



Conforme aux directives :

► 2006/42/CE



CODE	ARTICLE			PACK
0153206	RO-MA 90 COMBI RED LINE	90/	AX-TG	1



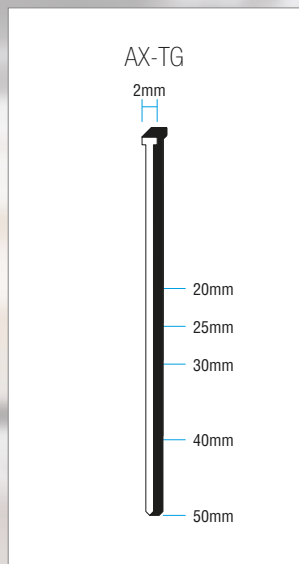
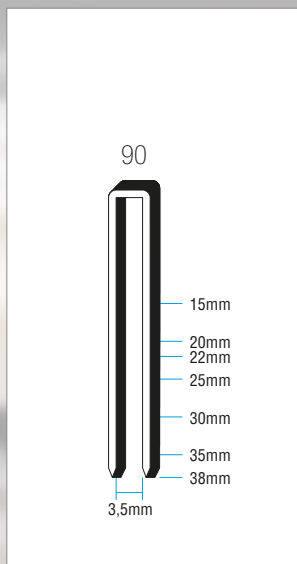

90 AX-TG

Il est conseillé d'utiliser des agrafes originales Maestri
Page 113, 116

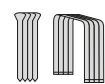

125 mm

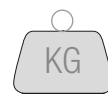

1,50



4/8

CLOUEUSES PNEUMATIQUES DE FINITION

Puissant, léger, compact.
Idéale pour les lames
en bois internes et
externes. Serrures, cadres.

Revêtements sur des
préfabriqués. Intérieurs
roulottes, caravanes,
nautique. Fixation couvre-

files muraux.
Charge latérale.

Manche en caoutchouc.



Caractéristiques :

Consommation en air
à 60 cycles/min : 47 l/min

Niveau sonore : LwA 102,1 dBA

Niveau de vibration : 3,6 m/s²

Disponibles en :



Conforme
aux directives :

► 2006/42/CE



CODE	ARTICLE	PACK	
0157302	RO-MA 30TG RED LINE	AX-TG	1



AX-TG

2mm



15mm

20mm

25mm

30mm

AX-TG

Il est conseillé d'utiliser des clous originaux Maestri
Page 116



125 mm



1,10



ATM

4/8

Idéale pour la fixation de profils sur bois, serrures et cadres. Fixation sur cadres sur meubles, couvre-fils muraux, lames en bois internes et externes. Revêtements sur des préfabriqués. Aménagements magasins, intérieurs roulottes, caravane, nautique. Charge latérale.

RO-MA 50TG

CODE	ARTICLE	AX-TG	PACK
0157342	RO-MA 50TG RED LINE		1

Manche en caoutchouc.



Caractéristiques :

Consommation en air à 60 cycles/min : 85 l/min

Niveau sonore : LwA 101 dBA

Niveau de vibration : 3,7 m/s²

Disponibles en :



Conforme aux directives :

► 2006/42/CE



AX-TG

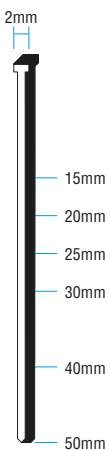

AX-TG

Il est conseillé d'utiliser des clous originaux Maestri
Page 116



125 mm

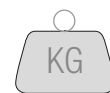

1,50



4/8

RO-MA 50 CONCRETE

CLOUEUSES PNEUMATIQUES DE FINITION

Cloueuses qui utilise deux typologies de clous. Type concret en acier trempé pour la fixation des plinthes et de

profils sur ciment et type GG en acier à haute résistance pour des applications de plinthe, production de chaises, couvre-

files, coffres mortuaires, meubles rustiques en style et internes de roulottes et caravane. Charge des clous latérale.

Manche en caoutchouc.



Caractéristiques :

Consommation en air à 60 cycles/min : 80 l/min

Niveau sonore : LpA 93,76 dBA
LwA 98,96 dBA

Niveau de vibration : 2,97 m/s²

Disponibles en :



Conforme aux directives :

► 2006/42/CE



CODE	ARTICLE			PACK
0231230	RO-MA 50 CONCRETE	Ø 1.83	GG	1

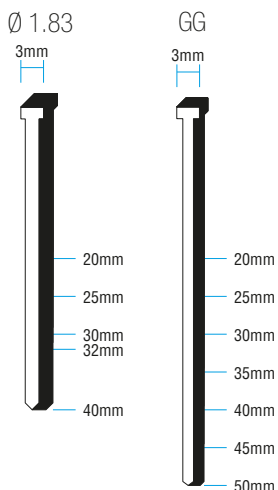

Ø 1.83 GG

Il est conseillé d'utiliser des clous originaux Maestri
Page 114, 115



127 mm



1,50



ATM

4,8/7,6

RO-MA 55 MULTIBRAD

Cloues qui utilise trois typologies de clous. Idéale pour la fixation de profils sur bois pour serrures et cadres.

Fixation de cadres sur les meubles et couvre-fils muraux. Lames en bois internes et externes. Revêtements sur des

préfabriqués. Ameublements magasins et aménagements de stands, intérieurs roulottes, caravane, nautique.

CODE	ARTICLE				PACK
0231255	RO-MA 55 MULTIBRAD	AX-TG	AY-LS2	AZ-LS	1



Manche en caoutchouc.



Caractéristiques :

Consommation en air à 60 cycles/min : 80 l/min

Niveau sonore : LpA 91,4 dBA
LwA 96,9 dBA

Niveau de vibration : 3,54 m/s²

Disponibles en :



Conforme aux directives :

► 2006/42/CE

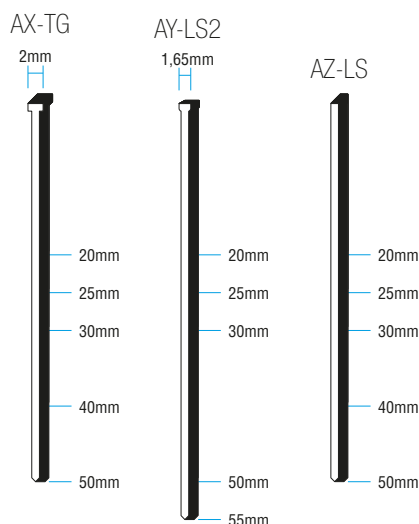

AX-TG | AY-LS2 | AZ-LS

Il est conseillé d'utiliser des clous originaux Maestri
Page 115, 116



130 mm

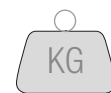

1,50



4,8/7,6

CLOUEUSES PNEUMATIQUES DE FINITION

Cloueuses pneumatiques qui utilisent des microbroches et des microbandes 064. Idéales pour la fixation : cadres sur les

meubles, couvre-fils muraux. Lames en bois internes et externes. Revêtements sur des préfabriqués. Fixation profilés

sur bois pour serrures et cadres. Aménagements magasins, intérieurs roulottes, caravane, nautique. Charge latérale.

Manche en caoutchouc.



Caractéristiques :

Consommation en air
à 60 cycles/min : 56,6 l/min
à 6,2 bar (10psi)

Niveau sonore : LpA 85 dBA

Niveau de vibration : 0,79 m/s²

Disponibles en :



Conforme
aux directives :

► 2006/42/CE



CODE	ARTICLE			PACK
0231239	RO-MA 30/64	M064CT	M064ST	1

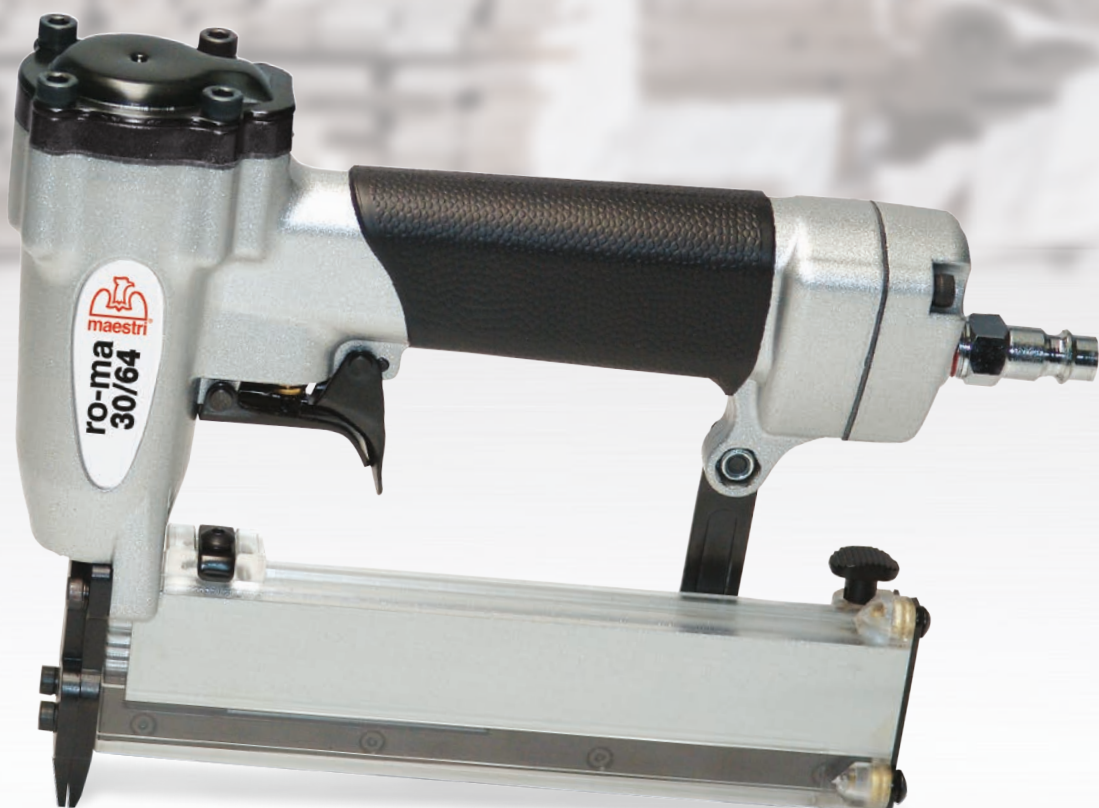

M064CT

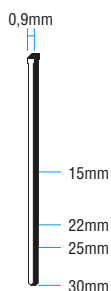

M064ST

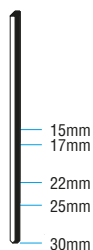

M064CT M064ST

Il est conseillé d'utiliser des clous originaux Maestri
Page 116



82 mm

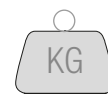

0,94



ATM

4/6

RO-MA 35/64

CODE	ARTICLE			PACK
0231241	RO-MA 35/64	M064CT	M064ST	1

Manche en caoutchouc.



Caractéristiques :

Consommation en air
à 60 cycles/min : 28,3 l/min
à 6,2 bar (10psi)
Niveau sonore : LpA 72 dBA
LwA 82,9 dBA
Niveau de vibration : 0,65 m/s²

Disponibles en :



Conforme
aux directives :

► 2006/42/CE



M064CT

0,9mm

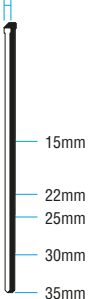

M064ST

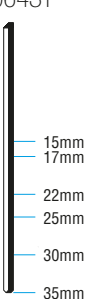

M064CT | M064ST

Il est conseillé d'utiliser des clous originaux Maestri
Page 116



82 mm

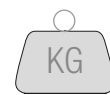

0,94



4/7

CLOUEUSES PNEUMATIQUES DE FINITION

Puissants, légers, compacts.
Idéales pour la fixation de
profils sur bois pour serrures
et cadres, cadres sur meubles,

couvres-fils muraux. Lames
en bois internes et externes.
Revêtements sur des
préfabriqués.

Aménagements magasins,
intérieurs roulottes, caravane,
nautique.
Charge latérale.

Manche en caoutchouc.



Caractéristiques :

Consommation en air
à 60 cycles/min : 43,3 l/min
à 6,2 bar (10psi)

Niveau sonore : LpA 88 dBA

Niveau de vibration : 3,2 m/s²

Disponibles en :



Conforme aux directives :

► 2006/42/CE



CODE	ARTICLE	PACK	
0231246	RO-MA 30/08	AP08	1



AP08

1,3mm



15mm
20mm
25mm
30mm

AP[®] 08

Il est conseillé d'utiliser des clous originaux Maestri
Page 115



170 mm



KG

1



ATM

4/7

RO-MA 45/08

CODE	ARTICLE	PACK	
0231237	RO-MA 45/08	AP08	1

Manche en caoutchouc.

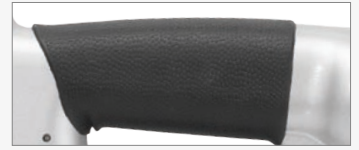

Caractéristiques :

Consommation en air
à 60 cycles/min : 20,5 l/min
à 6,2 bar (10psi)

Niveau sonore: LpA 87,54 dBA
LwA 93,25 dBA

Niveau de vibration : 1,85 m/s²

Disponibles en :



Conforme
aux directives :

► 2006/42/CE



AP08

1,3mm

H



AP[®] 08

Il est conseillé d'utiliser des clous originaux Maestri
Page 115



142 mm



1,10



4,1/6,9

Appareil pneumatique pour un affichage rapide et précis de clous tapissiers sur ruban, simple à charger

et pratique à utiliser. Fusion en alliage spécial en aluminium. Système pneumatique

d'avancement des clous très pratique utilisé chez les fabricants de meubles, pour les meubles et les

Chargeur en nylon 30 % fibres de verre.



Caractéristiques :

Consommation en air
à 60 cycles/min : 18 l/min
à 6,2 bar (10psi)

Niveau sonore : LpA 80,2 dBA
LwA 92,6 dBA

Niveau de vibration : 2,9 m/s²

Disponibles en :



Conforme aux directives :

► 2006/42/CE



CODE	ARTICLE				PACK
0290108	B6 PN/2	6/GL	6/AN	7S/AN	1
0290120	B10 PN/2	10/GL	10/AN		1
0290125	B11 PN/2	11/GL			1

MADE in ITALY

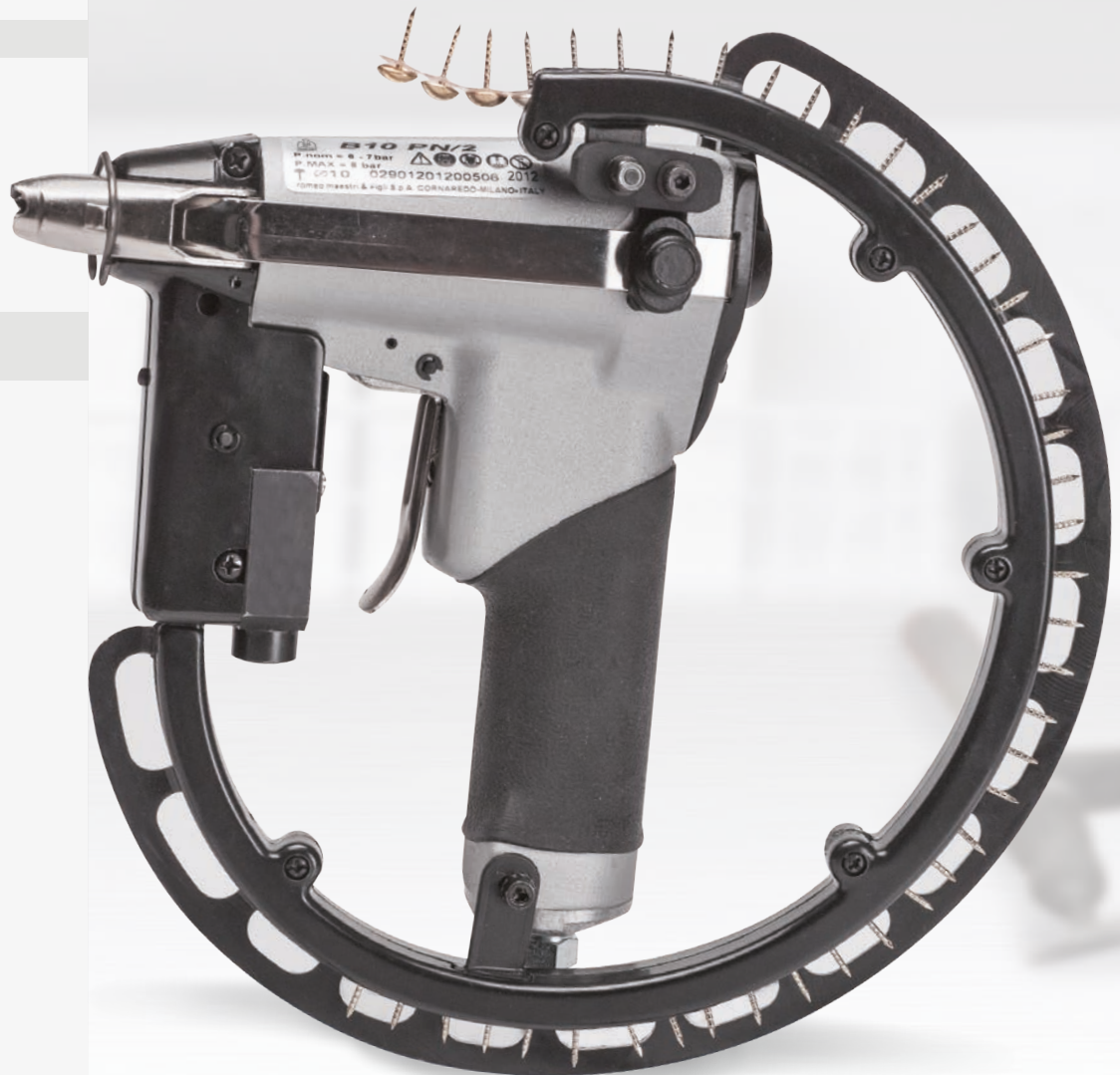

6/GL-AN | 7S/AN | 10/GL-AN | 11/GL

fauteuil stylés, chez les
cordonniers, les sabotiers,
pour de travaux de
décoration (comme le

clouage de coffres et de
malles, etc.).

Disponible en 3 modèles.

Mod. B6 PN/2

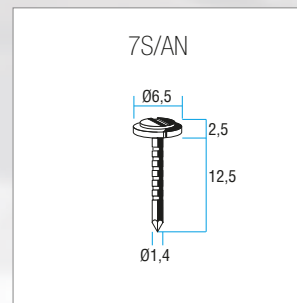
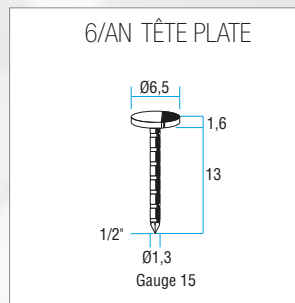
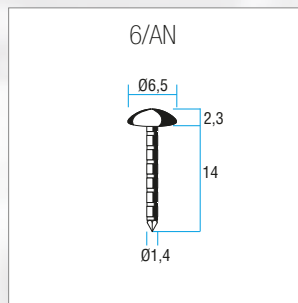
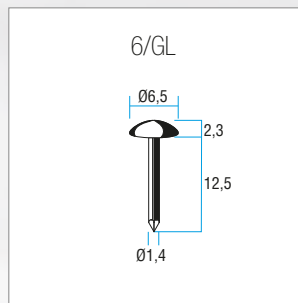

Également disponibles
avec l'empreinte SCR

Mod. B10 PN/2

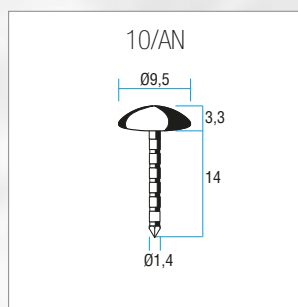
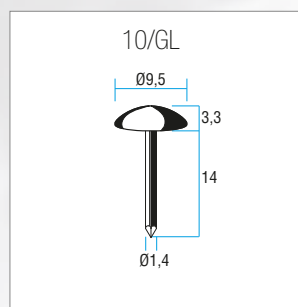

Mod. B11 PN/2

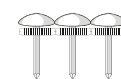
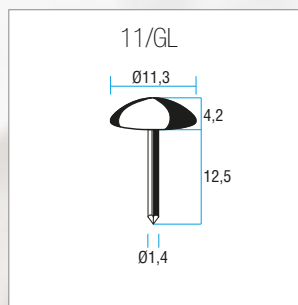

45/75



1



6/8

F12	66
FP12	67
F18	68
FP18	69
F15 FLEX	70
FP15 FLEX	71





CLOUEUSES POUR CADRES

MANUEL

*Pour tous les types
d'application de cadres et
d'étalages.
Fixation permanente.*

Régulateur de puissance.



Stabilisateur.



Caractéristiques :

Niveau sonore : LpA 80,4 dBA
LwA 88,8 dBA

Niveau de vibration : 1,1 m/s²

Disponibles en :



CODE	ARTICLE	PACK
0123001	F12	Brads F12 E 4

MADE in ITALY



BRADS F

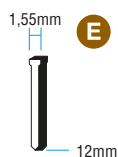

BRADS F12

Il est conseillé d'utiliser des clous originaux Maestri
Page 118



68 mm



KG

0,65

PNEUMATIQUE

Pour une utilisation intensive.



FP12

CODE	ARTICLE	PACK
0123302	FP12	Brads F12 E 1

 MADE in ITALY



2.000 BRADS F12 ►
INCLUS

Régulateur de puissance.

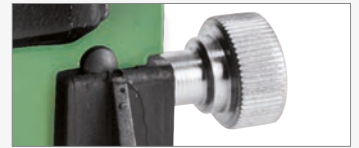

Stabilisateur.



Collecteur extensible pour air comprimé.



Caractéristiques :

Consommation en air à 60 cycles/min : 14 l/min

Disponibles en :



Conforme aux directives :

► 2006/42/CE



BRADS F

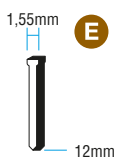

BRADS F12

Il est conseillé d'utiliser des clous originaux Maestri
Page 118



68 mm



0,85



4/6

CLOUEUSES POUR CADRES MANUEL

Pour tous les types
d'application de cadres.
Fixation permanente.

Régulateur de puissance.

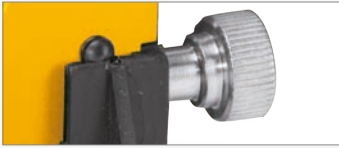

Stabilisateur.



Caractéristiques :

Niveau sonore : LpA 80,4 dBA
LwA 88,8 dBA

Niveau de vibration : 1,1 m/s²

Disponibles en :



CODE	ARTICLE	PACK
0123010	F18	Brads F18 E 4

MADE in ITALY



BRADS F

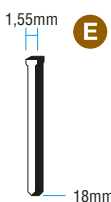

BRADS F18

Il est conseillé d'utiliser des clous originaux Maestri
Page 118



68 mm



0,65

CODE	ARTICLE	PACK
0123311	FP18	Brads F18 E 1

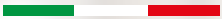
 MADE in ITALY



2.000 BRADS F18 ►
INCLUS

Régulateur de puissance.

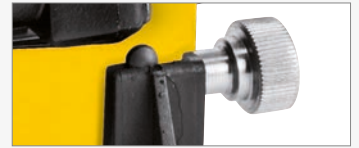

Stabilisateur.



Collecteur extensible pour air comprimé.



Caractéristiques :

Consommation en air à 60 cycles/min : 14 l/min

Disponibles en :



Conforme aux directives :

► 2006/42/CE
CE UK CA

BRADS F

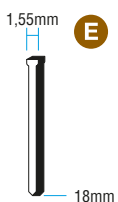

BRADS F18

Il est conseillé d'utiliser des clous originaux Maestri
Page 118



68 mm

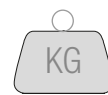

0,85



4/6

CLOUEUSES POUR CADRES MANUEL

*Pour les lamelles flexibles
repliables plusieurs fois
sans dommage pour les
photos et les peintures.*

Régulateur de puissance.

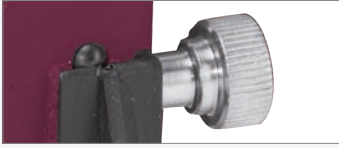

Stabilisateur.



Caractéristiques :

Niveau sonore : LpA 80,4 dBA
LwA 88,8 dBA

Niveau de vibration : 1,1 m/s²

Disponibles en :



CODE	ARTICLE	PACK
0123133	F15 FLEX	Romaflex 15 4

MADE in ITALY



ROMAFLEX 15

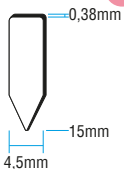

ROMAFLEX 15

Il est conseillé d'utiliser des lamelles originales Maestri
Page 118

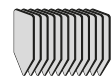

68 mm



0,65

CODE	ARTICLE	PACK
0123313	FP15 FLEX	Romaflex 15 1

MADE in ITALY



2.080 LAMELLES ▶
FLEXITABS INCLUDES

Régulateur de puissance.



Stabilisateur.



Collecteur extensible pour air comprimé.



Caractéristiques :

Consommation en air à 60 cycles/min : 14 l/min

Disponibles en :



Conforme aux directives :

▶ 2006/42/CE



ROMAFLEX 15

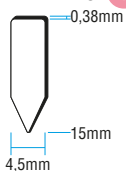

ROMAFLEX 15

Il est conseillé d'utiliser des lamelles originales Maestri
Page 118

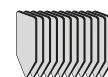

68 mm

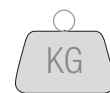

0,85



4/6

ROAMA MANUAL	74
ROAMA PNEUMATIC	75
ELPABOX BH	76
ELPABOX BA	77
RI-19/A	78
RO-MA 73	79
GF135 MECCANICA	80
GF135 PNEUMATICA	81



AGRAFEUSES POUR CARTONS

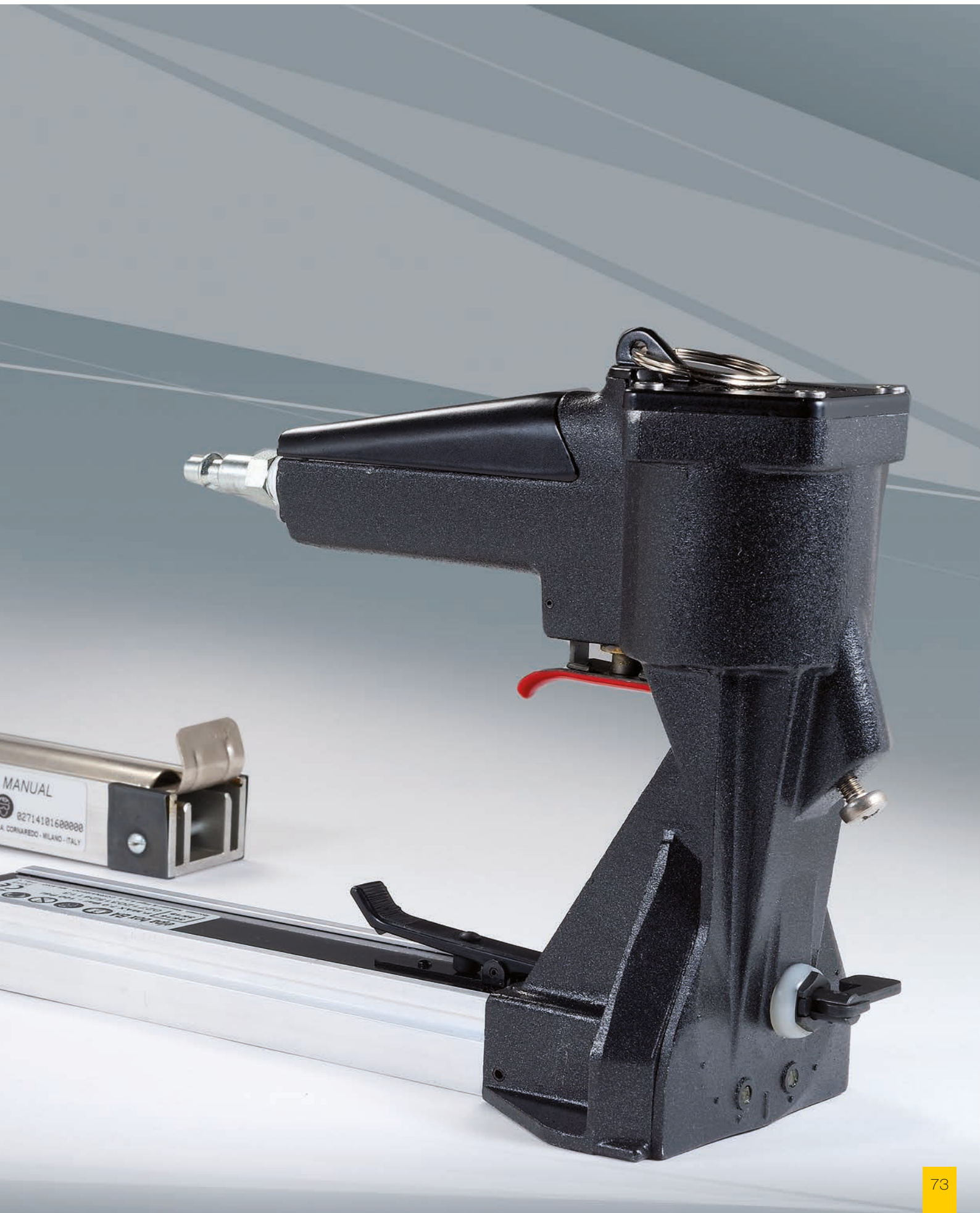

ROAMA MANUAL

AGRAFEUSES MANUELLES

Agrafeuse manuelle pour la fermeture de boîtes en carton ondulé. Étudié pour garantir avec un effort

minimum des prestations élevées en phase de fermeture des cartons. Dans la zone antérieure du corps

se trouve une poignée qui rend l'outil plus maniable même en cas de travaux intenses.

Corps de la machine moulé en alliage d'aluminium très résistant.



Manche très pratique.



Disponibles en :

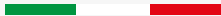

 MADE in ITALY

CODE	ARTICLE	PACK	
0271401	ROAMA 35/15	35/	1
0271405	ROAMA 35/19	35/	1
0271410	ROAMA 35/22	35/	1

Disponible en 3 modèles.

Mod. 35/15

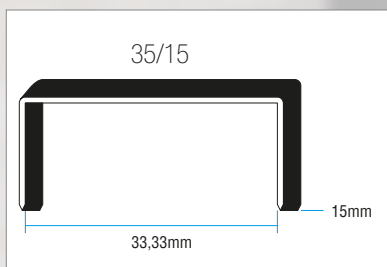

Mod. 35/19

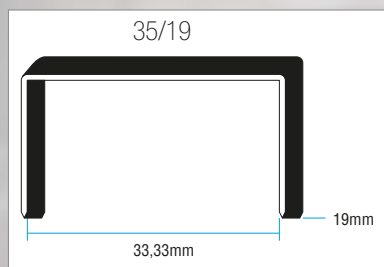

Mod. 35/22

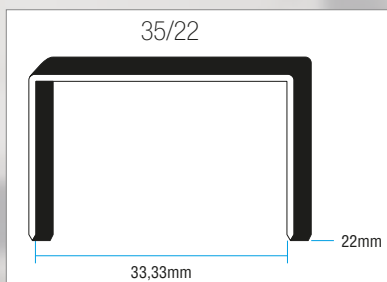

35

Il est conseillé d'utiliser des agrafes originales Maestri
Page 119



210 mm



KG

2,16

AGRAFEUSES PNEUMATIQUES



*Agrafeuse pneumatique
pour la fermeture de boîtes
en carton ondulé,
étudiée pour garantir des*

*prestations élevées
en phase de fermeture
des cartons.*

ROAMA PNEUMATIC

CODE	ARTICLE	35/	PACK
0271501	ROAMA 35/15	35/	1
0271505	ROAMA 35/19	35/	1
0271510	ROAMA 35/22	35/	1

Disponible en 3 modèles.

Mod. 35/15

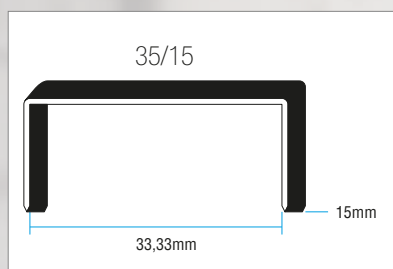

Mod. 35/19

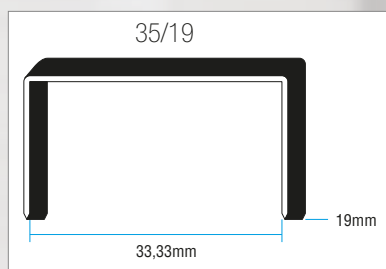

Mod. 35/22

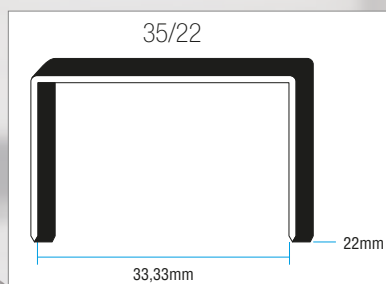

Corps de la machine moulé en alliage d'aluminium très résistant.



Crochet pratique.



Caractéristiques :

Consommation en air
à 60 cycles/min : 84 l/min

Niveau sonore : LpA 80,9 dBA
LwA 94 dBA

Niveau de vibration : 2,81 m/s²

Disponibles en :



Conforme aux directives :

► 2006/42/CE



MADE in ITALY



35

Il est conseillé d'utiliser des agrafes originales Maestri
Page 119



210 mm



2,60



6

AGRAFEUSES MANUELLES

Agrafeuse légère et maniable. Indiquée pour la fermeture des couvercles, des fonds de boîtes et de carton ondulé. Corps en

alliage spécial d'aluminium. Le manche antérieur garantit une plus grande stabilité et rapidité de couture. Équipé d'un réglage

de la profondeur d'agrafage et de forme du point. Deux hauteurs d'agrafes métalliques dans la même machine.

Régulateur de profondeur.



Manche très pratique.



Disponibles en :



CODE	ARTICLE	35/	PACK
0271103	ELPABOX BH-35		1

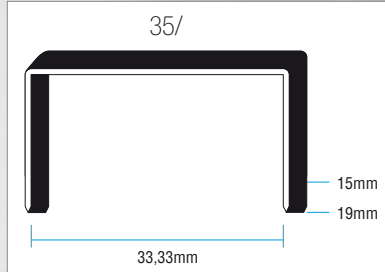

MADE in ITALY



35/15

35/19

35

Il est conseillé d'utiliser des agrafes originales Maestri
Page 119



200 mm



1,30

AGRAFEUSES PNEUMATIQUES



ELPABOX BA

Agrafeuse pneumatique compacte et légère, étudiée pour garantir des prestations élevées en phase

de fermeture des cartons. Équipée d'une grande surface d'appui qui évite les déplacements gênants

en phase d'agrafage. Réglage de la profondeur de fermeture de fermeture et conformation du point.

CODE	ARTICLE	35/	PACK
0271203	ELPABOX BA-35		1

 MADE in ITALY

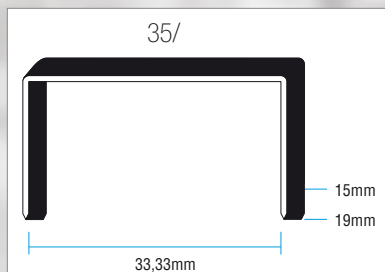

Régulateur de profondeur.



Corps de la machine moulé en alliage d'aluminium très résistant.



Caractéristiques :

Consommation en air à 30 cycles/min : 33 l/min
 Niveau sonore : LpA 78,5 dBA
 LwA 91,5 dBA
 Niveau de vibration : 2,41 m/s²

Disponibles en :



Conforme aux directives :

► 2006/42/CE



35/15

35/19

35

Il est conseillé d'utiliser des agrafes originales Maestri
 Page 119



200 mm



1,60



ATM

5/7

RI-19/A

Agrafeuse compacte et légère équipée d'une large surface d'appui qui évite les déplacements

gênants en phase d'agrafage. Adaptée pour la fermeture en série de boîtes en carton

ondulé. Réglage de la profondeur de fermeture et conformation du point.

Corps de la machine moulé en alliage d'aluminium très résistant.

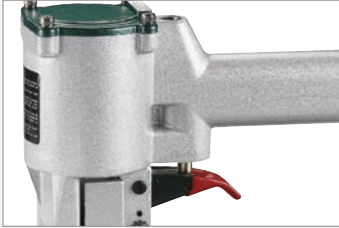

Caractéristiques :

Consommation en air à 60 cycles/min : 67 l/min

Niveau sonore : LpA 89 dBA
LwA 95 dBA

Niveau de vibration : 3,8 m/s²

Conforme aux directives :

► 2006/42/CE



CODE	ARTICLE		PACK
0271230	RI-19/A	M15/A - M19/A	1

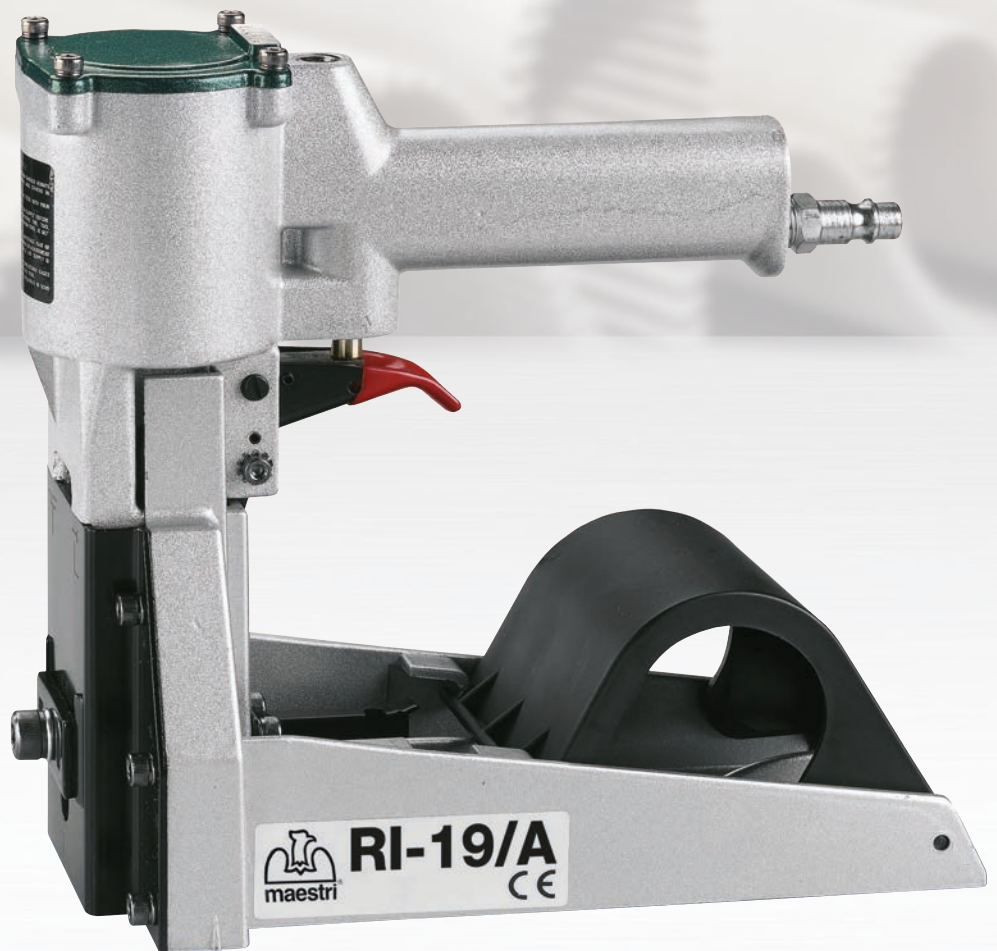

M15/A - M19/A

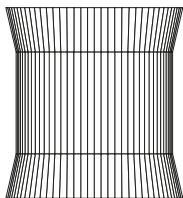

M15/A M19/A



1000



2,40



5/7

Il est conseillé d'utiliser des agrafes originales Maestri
Page 120

RO-MA 73

Agrafeuses équipées particulièrement adaptée à l'agrafage d'épaisseurs moyennes-grandes, (sachets,

petits cartons, sachets rembourrés, boîtes en carton ondulé, etc.). Très robuste, avec arrêt de sécurité

pour la main. Chargement traditionnel depuis l'arrière. Capacité de fermeture : environ 6 mm.

CODE	ARTICLE	73/	PACK
0040120	RO-MA 73	73/	5
0099205	RO-MA 73 KIT (73/8 - 73/10 - 73/12) - 15.000	73/	1

Arrêt de sécurité.



Base à baïonnette pour la fermeture des morceaux de boîtes en carton.



Base arrondie pour la fermeture des sachets en cellophane et en polyéthylène.



Disponibles en :

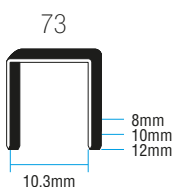

73

Il est conseillé d'utiliser des agrafes originales Maestri
Page 119



93 mm

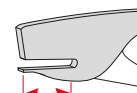

68 mm



0,46

GF135 MECCANICA

Agrafeuses conçues pour la fermeture de boîtes en carton ondulé.

Pédale mécanique.

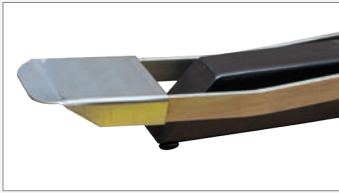

Dispositif de sécurité.



CODE	ARTICLE	PACK	
0271705	GF135 MECCANICA	35/	1

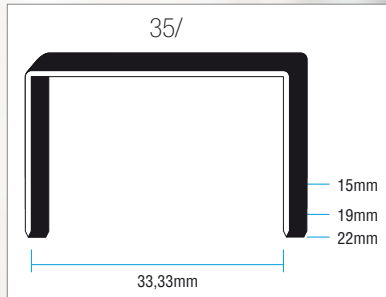

MADE in ITALY



35/15

35/19

35/22

35

Il est conseillé d'utiliser des agrafes originales Maestri
Page 119



380 mm



KG

35

Pour une utilisation intensive.

GF135 PNEUMATICA

CODE	ARTICLE	35/	PACK
0271725	GF135 PNEUMATICA		1

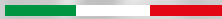
 MADE in ITALY

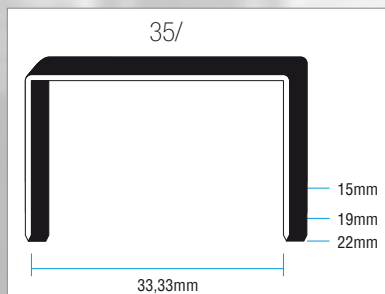

Pédale à commande pneumatique.



Dispositif de sécurité.



Caractéristiques :

Consommation en air
à 60 cycles/min : 170 l/min
Niveau sonore : LpA <80 dBA
Niveau de vibration : < 2,5 m/s²

Conforme aux directives :

► 2006/42/CE



35

Il est conseillé d'utiliser des agrafes originales Maestri
Page 119



380 mm

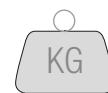

35



5/7

MULTENS	84
B051	86
320 - M13-32	87
BAND-IT C001	88
FA/PLAST - MPL	90
TB 1216	92
TB 1620	93
M4000 - PR/P	94
EASY PACK	95



CERCLAGE
SCELLEUSE



TENDEURS DE FEUILLARD MANUELS FEUILLARD EN MÉTAL

Utilisé pour cercler des cols de différent type, dimension et matériel (plastique, bois, etc.)

avec cerclage métallique et scellés relatifs en acier. Il effectue une opération de cerclage et de coupe-feuillard.

Robuste, maniable, facile à utiliser.

Poinçon réglable pour les mesures 13-16 mm/18-20 mm.



Disponibles en :

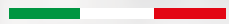

CODE	ARTICLE	PACK
0173310	MULTENS FB4	1
0173312	MULTENS FB320	1

 MADE in ITALY



Mod. FB4 poinçon réglable

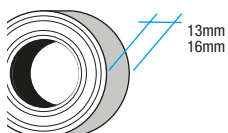

Page 121

Mod. FB320 poinçon réglable

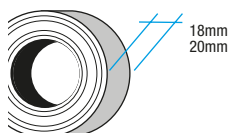

Page 121



3,90

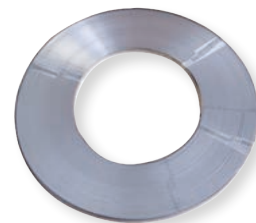

**ŞCELLÉS ACIER NEUTRES ET
AVEC LÉGENDE (exécutions pour 50.000 pcs)**

CERCLAGE MÉTALLIQUE AVEC BORDS ARRONDIS

ø interne 300 mm - ø externe 550 mm

épaisseur 0,3 mm

épaisseur 0,5 - 0,6 - 1 mm

313

316

320

13

16

18

20

**MULTENS
FB4**

•

•

•

•

**MULTENS
FB320**

•

•

•

TENDEURS DE FEUILLARD MANUELS FEUILLARD EN MÉTAL

*Tendeur de feuillard
universel pour feuillard en
acier.*

*Idéal pour les cerclages
verticaux et horizontaux.*

Système de fermeture
encastrable et découpe feuillard.

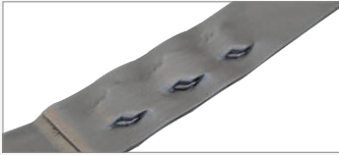

CODE	ARTICLE	PACK
0292120	B051	1

SANS SCELLÉ



Mod. B051

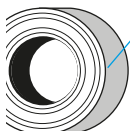

13mm
16mm
18mm
19mm
20mm
épaisseur
0,60mm

Page 121



4,25

PORTE-FEUILLARD FEUILLARD EN MÉTAL

Porte-feuillard pour feuillard
en métal. Bobine Ø externe
de 500 à 600 mm.



320 - M13-32

Équipées de roues pour
faciliter les déplacements.

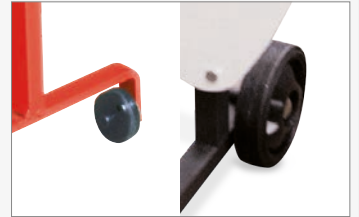

CODE	ARTICLE	PACK
0191121	320	1
0191133	M13-32	1

 MADE in ITALY

Mod. 320

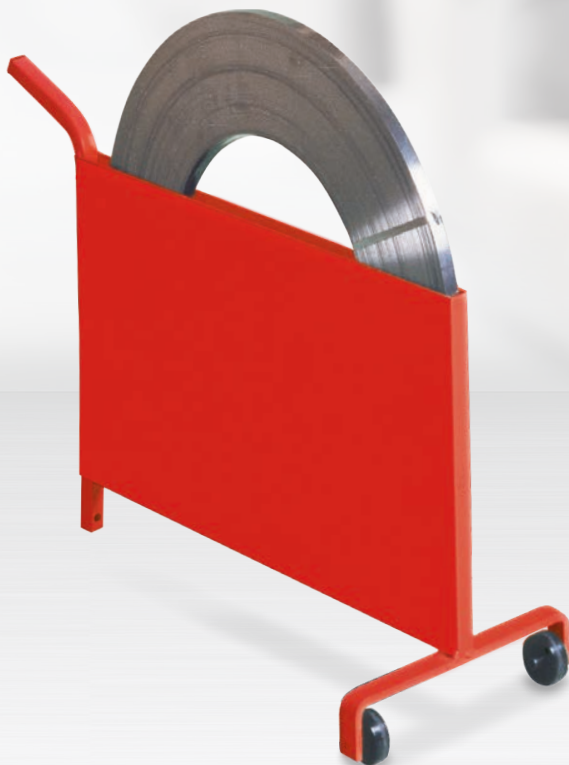

Mod. M13-32



Mod. 320

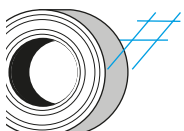

10mm
20mm

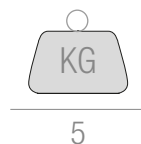

5

Page 121

Mod. M13-32

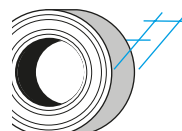

13mm
32mm



9,40

Page 121

*Outil en acier pour tension
bandes inox.*

BAND-IT C001

Corps machine robuste.



Disponibles en :



CODE	ARTICLE	PACK
0173601	C001 BAND-IT	1





Ruban Band-It

CODE	ARTICLE	MATÉRIEL	MT	PACK	Charge Rupture Kg/mm ²
1180001	C202 6,4x0,51 mm - 1/4"	INOX	30	1	225
1180003	C203 9,5x0,64 mm - 3/8"	INOX	30	1	400
1180005	C204 12,7x0,76 mm - 1/2"	INOX	30	1	680
1180007	C205 15,9x0,76 mm - 5/8"	INOX	30	1	890
1180009	C206 19,1x0,76 mm - 3/4"	INOX	30	1	1090



Agrafes Band-It

CODE	ARTICLE	MATÉRIEL	UNITÉS	PACK
1181001	C252 6,4 mm - 1/4"	INOX	100	1
1181003	C253 9,5 mm - 3/8"	INOX	100	1
1181005	C254 12,7 mm - 1/2"	INOX	100	1
1181007	C255 15,9 mm - 5/8"	INOX	100	1
1181009	C256 19,1 mm - 3/4"	INOX	100	1

TENDEURS DE FEUILLARD MANUELS FEUILLARD EN PLASTIQUE

Tendeurs manuels à traction directe pour feuillards en polypropylène. Levier

d'actionnement en tôle imprimée équipée de manches commodes antiglisse, base d'appui

en aluminium moulé couleur rouge, robuste et très ample. Adaptées à la fermeture

Version avec étrier idéal pour cerclages verticaux.

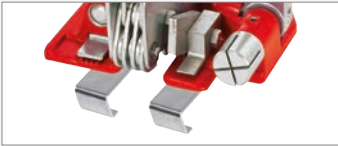

Disponibles en :

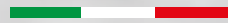

CODE	ARTICLE	PACK
0173111	FA/PLAST 13-16	1
0173113	MPL 13	1
0173114	MPL 16	1
0173106	MPL 13 C/ ÉTRIER	1
0173109	MPL 16 C/ ÉTRIER	1

 MADE in ITALY



Mod. FA/PLAST 13-16

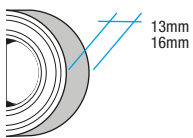

Page 123

Mod. MPL13

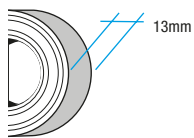

Page 123

Mod. MPL16

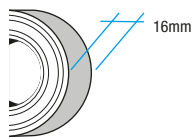

Page 123



2,60

de boîtes en carton
ondulé et d'emballages de
différent type et dimension,
garantissent avec des

efforts minimums sur
le levier une fermeture
hermétique du scellé de
type ouvert.

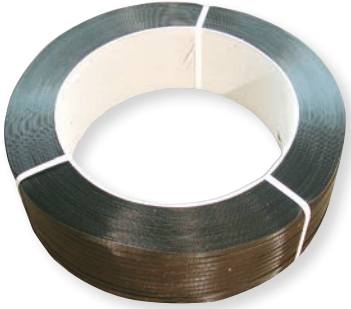
				
				<p>SCELLÉS EN ACIER POINTÉ ET AVEC LÉGENDE (exécution pour 50.000 pcs)</p>
<p>épaisseur 0,4 mm (LA) - 0,5 mm (PA)</p>		<p>épaisseur 0,5 - 0,6 - 0,8 mm</p>		
	13	16	12	15
FA/PLAST 13-16	•	•	•	•
MPL 13	•		•	
MPL 16		•		•

TENDEUR DE FEUILLARD EN BATTERIE FEUILLARD EN PLASTIQUE

Tendeur de feuilard en batterie parmi les plus légers de sa catégorie, utiliser un feuilard en polypropylène

(PP) et polyester (PET) de 12-15 mm sans utiliser le scellé. Utilisable d'une seule main.

Tension maximale 250 KG (2500N) tension standard.

Manche très pratique.



Bouton de relâchement batterie.



Bouton de tension **A**
Levier de soudure **B**



Disponibles en :



Conforme aux directives :

- ▶ ROHS
- ▶ La batterie au lithium respecte les normes UN 38.3 en fonction des normes de sécurité
- ▶ 2006/42/CE



CODE	ARTICLE	PACK
0292146	TB 1216	1

SANS SCELLÉ



COMPREND LE CHARGEUR DE BATTERIE ET LA BATTERIE AU LITHIUM

Mod. TB 1216

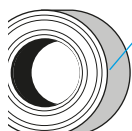

12mm
16mm

épaisseur
0,65-1,00mm

Page 123



BATTERIE AU LITHIUM
18V 400mAh

3,50
BATTERIE
INCLUDE

TB 1620

Tendeur de feuillard en batterie parmi les plus légers de sa catégorie, utiliser un feuillard en polypropylène (PP)

et polyester (PET) de 15-19 mm sans utiliser le scellé. Utilisable d'une seule main.

Tension maximale 4000 KG (4000N) tension élevée.

CODE	ARTICLE	PACK
0292147	TB 1620	1

SANS SCELLÉ



COMPREND LE CHARGEUR DE BATTERIE ET LA BATTERIE AU LITHIUM

Manche très pratique.



Bouton de relâchement batterie.



Bouton de tension **A**
Levier de soudure **B**



Disponibles en :



Conforme aux directives :

- ▶ ROHS
- ▶ La batterie au lithium respecte les normes UN 38.3 en fonction des normes de sécurité
- ▶ 2006/42/CE

CE UK CA

Mod. TB 1620

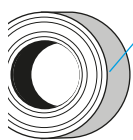

15mm
19mm

épaisseur
0,70-1,27mm

Page 123



BATTERIE AU LITHIUM
18V 400mAh



3,50
BATTERIE
INCLUDE

PORTE-FEUILLARD

FEUILLARD EN PLASTIQUE

Porte-feuillard pour des bobines de feuillard en polypropylène.
Chargement frontal.

M4000: grandes bobines
Ø interne 395/400 mm

PR/P: petites bobines
Ø interne 60/62 mm

M4000 - PR/P

M4000

Pratique compartiment porte-outil.



PR/P

Crochet de soutien.

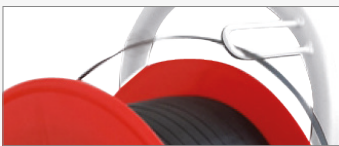

CODE	ARTICLE	PACK
0191103	M4000	1
0191101	PR/P	1

MADE in ITALY



Mod. M4000



Mod. PR/P

Mod. M4000

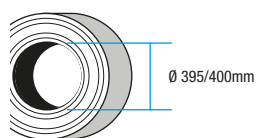

Page 123

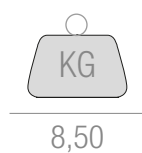

Mod. PR/P

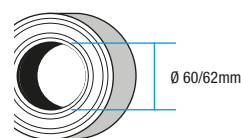

Page 123

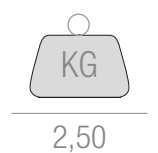

KIT D'EMBALLAGE



Facile à utiliser, idéal pour des cartons, des caisses, des tuyaux, des documents et des archives, des livres, etc.

EASY PACK

CODE	ARTICLE	PACK
0199994	KIT EASY PACK	1

600 m de feuilard PP.



200 scellés en plastique.



1 coupeur.



Disponibles en :

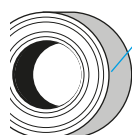

12mm

Page 123

épaisseur
0,45mm



KG

2,80

MINIGRIP 7H	98
GRIP 11H	99
GRIP 15HL	100
GRIP 18HP	101
GRIP 20XP	102
M 195	103
M 220	104
M 3350	105
M 812	106
M812 MG	107
M12/M7/H12/L12	108





MINIGRIP 7H

HOBBY

Buse anti-goutte avec protection en silicone.



Puissance 10 W.

Trépied d'appui.



Disponibles en :



Conforme aux directives :

- ▶ ROHS
- ▶ 2006/42/CE



COLLEUSES

Colleuse électrique pour adhésifs thermofusibles de ligne neuve, légère

et maniable pour le « bricolage », particulièrement adaptée pour les petites réparations, Ø 7 mm.

fixation de composants en céramique, verre et bois. Pour colles standards

CODE	ARTICLE	PACK
0195122	MINIGRIP 7H	12



Couleur colle disponible :

- Transparent

M7

Il est conseillé d'utiliser des colles originales Maestri
Page 109

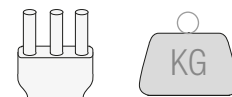

AC220/240V
50-60 Hz

0,17

Colleuse électrique pour
adhésifs thermofusibles
de ligne neuve, légère et
maniable pour le
bricolage, adaptée pour les
montages et les réparations
sur bois, plastique, carton,
caoutchouc et cuir, pose et
réparation de carrelage et
de porcelaine.
Pour colles standards
Ø 12mm.

GRIP 11H

HOBBY

Buse anti-goutte avec
protection en silicone.

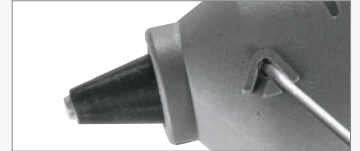

Puissance 30W.

Sortie maximale de
colle/heure : 360g/h.

Trépied d'appui.



Disponibles en :



Conforme
aux directives :

- ▶ ROHS
- ▶ 2006/42/CE

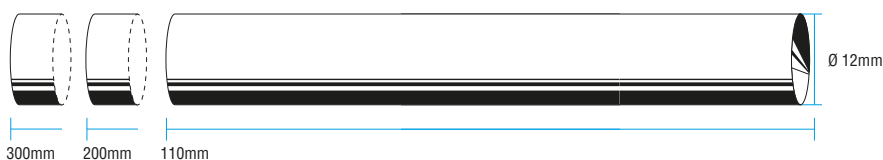

Couleurs colles disponibles :

- Transparent
- Blanc
- Miel
- Rouge
- Noir
- Gris

M12 | H12

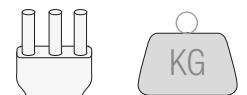

Il est conseillé d'utiliser
des colles originales Maestri
Page 109

AC220/240V
50-60 Hz

0,25

GRIP 15HL

COLLEUSES

Colleuses électriques pour adhésifs thermofusibles de ligne neuve, légères et maniables pour le

"bricolage", adaptées pour les montages et les réparations sur bois, plastique, carton,

caoutchouc et cuir, pose et réparation de carrelage et de porcelaine. Pour colles standards Ø 12mm.

HOBBY

Buse isolée anti-goutte, dévissable, interchangeable.



Puissance 40W.

Sortie maximale de colle/heure : 530g/h.

Trépied d'appui.

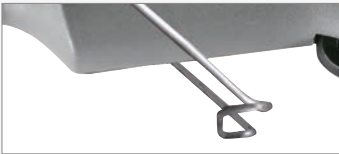

Disponibles en :



Conforme aux directives :

- ▶ ROHS
- ▶ 2006/42/CE



CODE	ARTICLE	PACK
0195136	GRIP 15HL	10

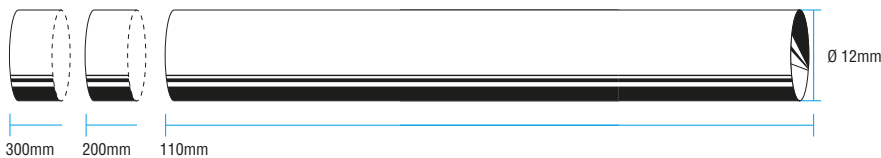

Couleurs colles disponibles :

- Transparent
- Blanc
- Miel
- Rouge
- Noir
- Gris

M12 | H12



Il est conseillé d'utiliser des colles originales Maestri
Page 109

AC220/240V
50-60 Hz

0,30

GRIP 18HP

HOBBY

Buse isolée anti-goutte, dévissable, interchangeable.



Puissance 60W.

Sortie maximale de colle/heure : 550g/h.

Trépied d'appui.

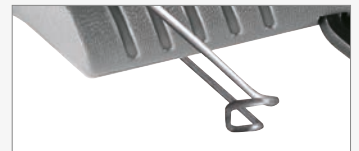

Disponibles en :



Conforme aux directives :

► ROHS

► 2006/42/CE



CODE	ARTICLE	PACK
0195137	GRIP 18HP	6

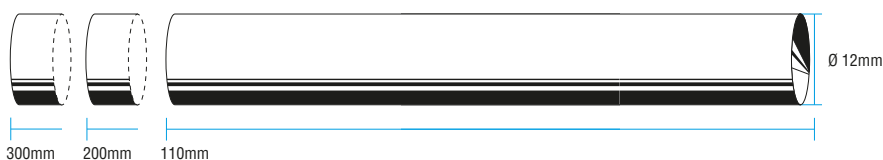

Couleurs colles disponibles :

- Transparent
- Blanc
- Miel
- Rouge
- Noir
- Gris

M12 | H12

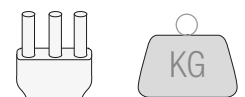

Il est conseillé d'utiliser des colles originales Maestri
Page 109

AC220/240V
50-60 Hz

0,31

COLLEUSES

Colleuse électrique pour adhésifs thermofusibles de ligne neuve, légère et maniable pour le « bricolage », particulièrement

adaptée pour les montages et les réparations sur bois, plastique, carton, caoutchouc et cuir, pose et réparation de carrelage et porcelaine. Équipée de

thermostat de sécurité qui prévoit l'arrêt de la colleuse si elle est laissée plus de 15 minutes arrêtée et de LED de mise sous tension. Pour colles standards Ø 12 mm.

HOBBY

Buse anti-goutte, dévissable, interchangeable.



Puissance 80W.

Sortie maximale de colle/heure : 1 kg/h.

Trépied d'appui.



Disponibles en :



comprend :

- ▶ 1 buse en brosse
- ▶ 1 buse à fil fin
- ▶ 6 sticks colle ø 12/100 transparent
- ▶ 6 sticks colle ø 12/100 miel

Classe d'isolation :

- ▶ CLASS 1

Conforme aux directives :

- ▶ ROHS
- ▶ 2006/42/CE



CODE	ARTICLE	PACK
0195138	GRIP 20XP	5

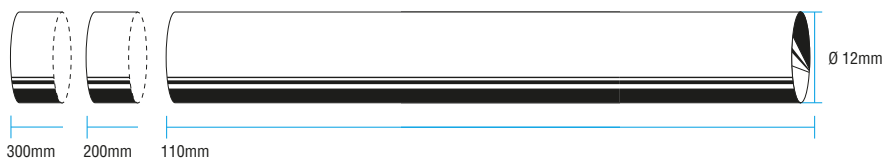

Couleurs colles disponibles :

- Transparent
- Blanc
- Miel
- Rouge
- Noir
- Gris

M12 | H12

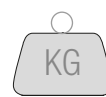

Il est conseillé d'utiliser des colles originales Maestri
Page 109

AC220/240V
50-60 Hz

0,50

Colleuse électrique pour adhésifs thermofusibles de ligne neuve. Légère et maniable pour une utilisation

professionnelle. Adaptée pour des montages et des réparations sur bois, plastique, carton, caoutchouc et cuir,

pose et réparation de carrelage et de porcelaine. Pour colles standards Ø 12 mm.

M 195

CODE	ARTICLE	PACK
0195220	M 195 RED LINE	1

PROFESSIONAL

Buse anti-goutte avec protection en silicone.



Puissance 120W.

Sortie maximale de colle/heure : 1,1 kg/h.

Trépied d'appui.



Interrupteur on/off.



Disponibles en :



comprend :

- ▶ 1 buse de rechange

Conforme aux directives :

- ▶ ROHS
- ▶ 2006/42/CE

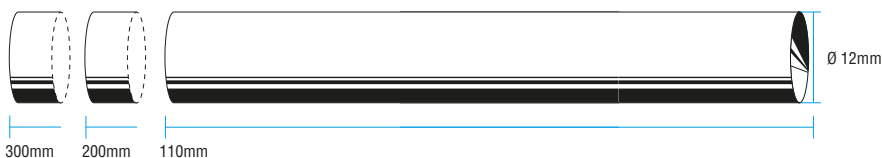

Couleurs colles disponibles :

- Transparent
- Blanc
- Miel
- Rouge
- Noir
- Gris

M12 H12

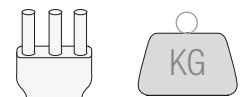

Il est conseillé d'utiliser des colles originales Maestri
Page 109

AC220/240V
50-60 Hz

0,47

M 220

COLLEUSES

Colleuses électriques pour adhésifs thermofusibles de ligne neuve. Légères et maniables pour une utilisation professionnelle. Adaptées pour des montages et des réparations sur bois, plastique, carton, caoutchouc et cuir, pose et réparation de carrelage et de porcelaine. Pour colles standards Ø 12 mm.

PROFESSIONAL

Buse anti-goutte, dévissable, interchangeable.



Puissance 220W.

Sortie maximale de colle/heure : 1,2 kg/h.

Trépied d'appui.



Thermostat réglable pour le contrôle de la température de fonctionnement.



Disponibles en :



comprend :

- ▶ 1 buse de rechange
- ▶ 1 tournevis

Classe d'isolation :

- ▶ CLASS 1

Conforme aux directives :

- ▶ ROHS
- ▶ 2006/42/CE

CODE	ARTICLE	PACK
0195221	M 220 RED LINE	1

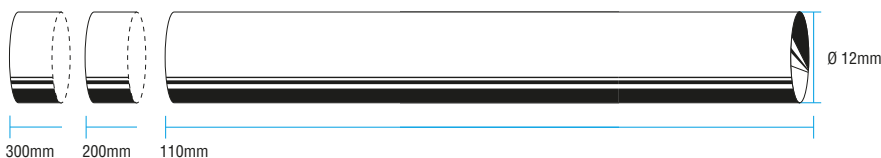

Couleurs colles disponibles :

- Transparent
- Blanc
- Miel
- Rouge
- Noir
- Gris

M12 | H12



Il est conseillé d'utiliser des colles originales Maestri
Page 109

AC220/240V
50-60 Hz

0,60

M 3350

Extreme PROFESSIONAL

Buse anti-goutte, dévissable, interchangeable.



Puissance 300 W.

Sortie maximale de colle/heure : 1,5 kg/h.

Thermostat réglable pour le contrôle de la température de fonctionnement.



Trépied d'appui.



Disponibles en :



comprend :

- ▶ 1 buse de recharge

Classe d'isolation :

- ▶ CLASS 1

Conforme aux directives :

- ▶ ROHS
- ▶ 2006/42/CE

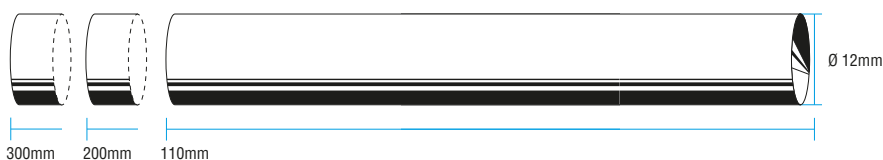

Couleurs colles disponibles :

- Transparent
- Blanc
- Miel
- Rouge
- Noir
- Gris

M12 H12

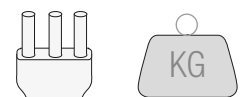

Il est conseillé d'utiliser des colles originales Maestri
Page 109

AC220/240V
50-60 Hz

0,70

COLLEUSE

Colleuse électrique pour adhésifs thermofusibles puissants, pour de grandes productions et des travaux

intenses. Adaptée à une utilisation professionnelle pour des montages et des réparations sur bois, plastique,

carton, caoutchouc et cuir, pose et réparation de carrelage et de porcelaine. Pour colles standards Ø 12 mm.

Extreme PROFESSIONAL

Buse anti-goutte, dévissable, interchangeable.



Puissance 400W.

Sortie maximale de colle/heure : 1,8 kg/h.

Thermostat réglable pour le contrôle de la température de fonctionnement.



Interrupteur on/off.



Disponibles en :



comprend :

- ▶ 1 buse de recharge
- ▶ 1 tournevis

Classe d'isolation :

- ▶ CLASS 1

Conforme aux directives :

- ▶ ROHS
- ▶ 2006/42/CE

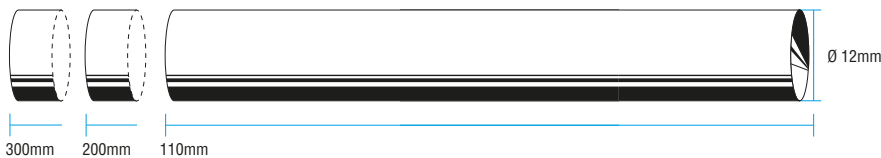

Couleurs colles disponibles :

- Transparent
- Blanc
- Miel
- Rouge
- Noir
- Gris

M12 | H12



Il est conseillé d'utiliser des colles originales Maestri
Page 109

AC220/240V
50-60 Hz

1,05

COLLEUSE AVANCE ÉLECTRONIQUE



Colleuse avec dispositif électronique innovant d'alimentation en colle pour les travaux les plus intensifs où une grande capacité d'extrusion

est nécessaire pour éviter la fatigue des mains. Convient à un usage professionnel pour le montage et les réparations sur le bois, le

plastique, le carton, le papier, le tissu, le caoutchouc, le cuir, la pose et la réparation de carreaux et de porcelaine. Pour les colles standard Ø 12 mm.

M812 MG

CODE	ARTICLE	PACK
0291114	M812 MG	1

Extreme PROFESSIONAL

Buse anti-goutte, dévissable, interchangeable.



Puissance 450W.

Sortie maximale de colle/heure : 2,5 kg/h.

Indicateur de température : lumière verte de prêt à l'emploi.



Interrupteur on/off.



Disponibles en :



comprend :

- ▶ 1 buse de recharge

Classe d'isolation :

- ▶ CLASS 1

Conforme aux directives :

- ▶ ROHS
- ▶ 2006/42/CE

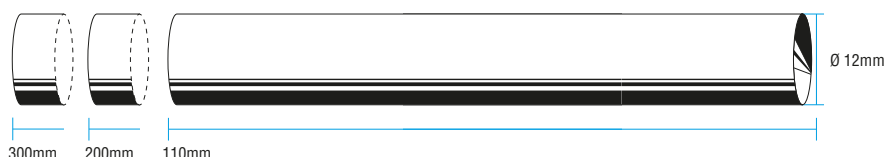

Couleurs colles disponibles :

- Transparent
- Blanc
- Miel
- Rouge
- Noir
- Gris

M12 H12

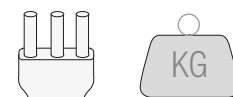

Il est conseillé d'utiliser des colles originales Maestri
Page 109

AC220/240V
50-60 Hz

1,40



M7/M12/H12 L12

Prodotto europeo
conforme au règlement.

► REACH (CE) n°1907/2006

STICK DE COLLE THERMOFUSIBLE

Pour assembler, coller et
réparer sur bois, plastique,
carton, papier, tissu, métal
pré-réchauffé, caoutchouc,

cuir.
Pose et réparation de
carrelages et de porcelaine.
Bijouterie, bricolage.

MADE in ITALY



Maestri, depuis toujours
sensible à la santé
environnementale, a choisi
d'utiliser l'énergie dérivante
de sources renouvelables
pour la production de cet
article.

Green energy
Maestri da sempre
sensible alla salute
ambientale, ha scelto
di utilizzare energia
derivante da fonti
rinnovabili per la
produzione di questo
articolo.
MADE IN ITALY

**COLLA TERMOFUSIBILE
HOT MELT GLUE STICKS**

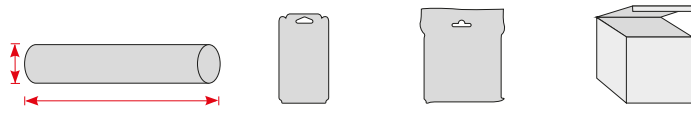

CODE	ARTICLE	PACK	STICK	BLISTER	SACHET	BOÎTE
1195207	M 12/200 TRANSPARENT	10	Ø 12 mm / 200 mm		● 1 kg	
1195210	M 12/200 MIEL	10	Ø 12 mm / 200 mm		● 1 kg	
1195212	M 12/200 MIEL ADAPTE AUX CARTONS BRILLANTS	10	Ø 12 mm / 200 mm		● 1 kg	
1195213	M 12/200 BLANCHE	5	Ø 12 mm / 200 mm			○ 5 kg
1195209	M 12/200 TRANSPARENT	5	Ø 12 mm / 200 mm			● 5 kg
1195215	M 12/200 MIEL	5	Ø 12 mm / 200 mm			● 5 kg
1196710	M 12/200 TRANSPARENT	10	Ø 12 mm / 200 mm	● 280 g		
1196711	M 12/200 BLANCHE	10	Ø 12 mm / 200 mm	○ 280 g		
1196712	M 12/200 MIEL	10	Ø 12 mm / 200 mm	● 280 g		
1195230	H 12/200 TRANSPARENT	5	Ø 12 mm / 200 mm			● 5 kg
1195234	H 12/200 TRANSPARENT	10	Ø 12 mm / 200 mm		● 1 kg	
1195250	H 12/300 TRANSPARENT	10	Ø 12 mm / 300 mm			● 10 kg
1195252	H 12/300 BLANCHE	10	Ø 12 mm / 300 mm			○ 10 kg
1196720	M 12/110 TRANSPARENT	12	Ø 12 mm / 110 mm	● 100 g		
1196721	M 12/110 ROUGE	12	Ø 12 mm / 110 mm	● 100 g		
1196722	M 12/110 NOIRE	12	Ø 12 mm / 110 mm	● 100 g		
1196723	M 12/110 GRISE	12	Ø 12 mm / 110 mm	● 100 g		
1196740	M 7/100 TRANSPARENT	24	Ø 7 mm / 100 mm	● 70 g		
1196750	M 7/100 TRANSPARENT	36	Ø 7 mm / 100 mm		● 200 g	
1295111	MIEL 213/43	10	Ø 43 mm / 43 mm			● 10 Kg
1195102	L 12/200 TRANSPARENT BASSE TEMPÉRATURE	5	Ø 12 mm / 200 mm		● 1 Kg	

FASTENING

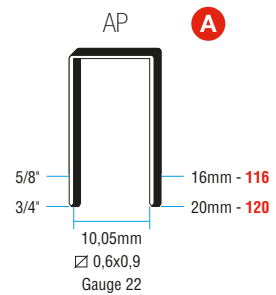
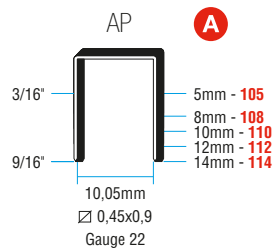
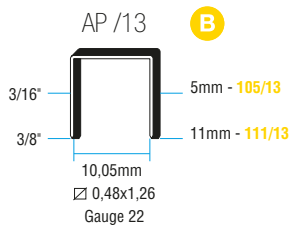

CODE	ARTICLE	PACK
1101503	105/13 AP - 5.000	240.000
>1110220	RO-MA 111/13 AP - 672	15

> blister

CODE	ARTICLE	PACK
1101301	105 AP - 5.000	300.000
1101303	108 AP - 5.000	240.000
1101207	112 AP - 5.000	150.000
1101209	114 AP - 5.000	120.000
>1110125	RO-MA 110 AP - 960	15
>1110126	RO-MA 112 AP - 840	15
>1110128	RO-MA 114 AP - 720	15

> blister

CODE	ARTICLE	PACK
1110130	RO-MA 116 AP - 600	15
1110132	RO-MA 120 AP - 480	15

> blister

PAGE

5 7 19 23

PAGE

5 7 9 11 13 18 19 21
23 25 29 33 37

PAGE

11 13 37

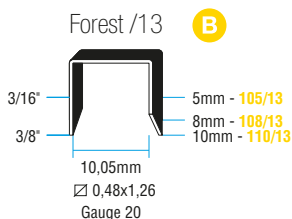

CODE	ARTICLE	PACK
1101401	105/13 FOREST - 5.000	240.000
1101403	108/13 FOREST - 5.000	180.000
1101405	110/13 FOREST - 5.000	120.000
1101402	105/13 FOREST BLACK EDITION - 5.000	50.000
1101404	108/13 FOREST BLACK EDITION - 5.000	50.000
1101406	110/13 FOREST BLACK EDITION - 5.000	50.000
>1110201	RO-MA 105/13 FOREST - 1.092	15
>1110203	RO-MA 108/13 FOREST - 840	15
>1110205	RO-MA 110/13 FOREST - 672	15

> blister

PAGE				
5	7	19	23	

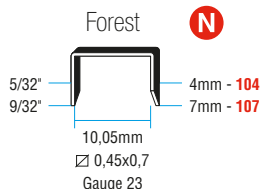

CODE	ARTICLE	PACK
1101001	104 FOREST - 5.000	480.000
1101007	107 FOREST - 5.000	360.000

PAGE				
5				

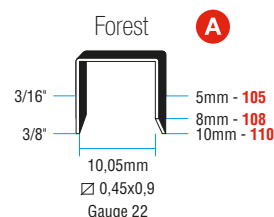

CODE	ARTICLE	PACK
1101201	105 FOREST - 5.000	300.000
1101203	108 FOREST - 5.000	240.000
1101205	110 FOREST - 5.000	210.000
1101202	105 FOREST BLACK EDITION - 5.000	50.000
1101204	108 FOREST BLACK EDITION - 5.000	50.000
1101206	110 FOREST BLACK EDITION - 5.000	50.000
>1110120	RO-MA 105 FOREST - 1.764	15
>1110122	RO-MA 108 FOREST - 1.764	15
>1110124	RO-MA 110 FOREST - 1.008	15

> blister

PAGE						
5	7	9	11	13	18	19
23	25	29	33	37		

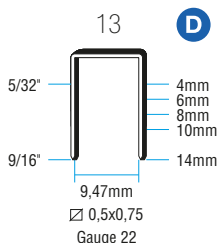

CODE	ARTICLE	PACK
1101701	M 13/4 ZINGUÉS - 5.000	80.000
1101703	M 13/6 ZINGUÉS - 5.000	70.000
1101705	M 13/8 ZINGUÉS - 5.000	110.000
1101707	M 13/10 ZINGUÉS - 5.000	80.000
1101711	M 13/14 ZINGUÉS - 5.000	60.000
>1110501	RO-MA 13/4 ZINGUÉS - 3.360	15
>1110503	RO-MA 13/6 ZINGUÉS - 2.240	15
>1110505	RO-MA 13/8 ZINGUÉS - 2.240	15
>1110507	RO-MA 13/10 ZINGUÉS - 1.120	15
>1110509	RO-MA 13/14 ZINGUÉS - 1.120	15

> blister

PAGE					
7	9	11	15	23	25
				25	37

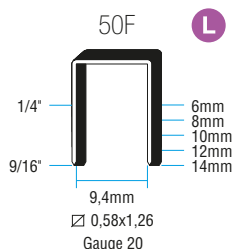

CODE	ARTICLE	PACK
1101801	M 50F/6 ZINGUÉS - 10.000	180.000
1101802	M 50F/8 ZINGUÉS - 5.000	160.000
1101803	M 50F/10 ZINGUÉS - 5.000	130.000
1101804	M 50F/12 ZINGUÉS - 5.000	110.000
1101805	M 50F/14 ZINGUÉS - 5.000	100.000
>1110601	RO-MA 50F/6 ZINGUÉS - 1.176	15
>1110603	RO-MA 50F/8 ZINGUÉS - 840	15
>1110605	RO-MA 50F/10 ZINGUÉS - 672	15
>1110607	RO-MA 50F/12 ZINGUÉS - 588	15
>1110609	RO-MA 50F/14 ZINGUÉS - 504	15

> blister

PAGE					
7	11	15	23	37	41

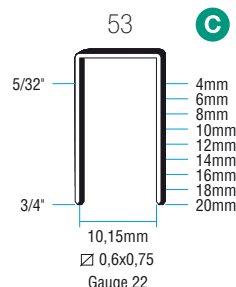

CODE	ARTICLE	PACK
1101603	M 53/6 ZINGUÉS - 5.000	280.000
1101605	M 53/8 ZINGUÉS - 5.000	270.000
1101607	M 53/10 ZINGUÉS - 5.000	240.000
1101609	M 53/12 ZINGUÉS - 5.000	210.000
1101611	M 53/14 ZINGUÉS - 5.000	180.000
1101613	M 53/16 ZINGUÉS - 4.000	144.000
1101615	M 53/18 ZINGUÉS - 3.000	126.000
1101616	M 53/20 ZINGUÉS - 3.000	126.000
>1110320	RO-MA 53/4 ZINGUÉS - 2.940	15
>1110322	RO-MA 53/6 ZINGUÉS - 1.960	15
>1110324	RO-MA 53/8 ZINGUÉS - 1.960	15
>1110326	RO-MA 53/10 ZINGUÉS - 1.120	15
>1110328	RO-MA 53/12 ZINGUÉS - 980	15
>1110330	RO-MA 53/14 ZINGUÉS - 840	15
>1110332	RO-MA 53/16 ZINGUÉS - 700	15
>1110334	RO-MA 53/18 ZINGUÉS - 560	15
>1110336	RO-MA 53/20 ZINGUÉS - 560	15

> blister

PAGE						
5	7	9	11	13	16	17
23	25	33	35	37		

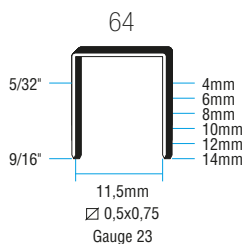

CODE	ARTICLE	PACK
1201001	64/4 COLORIS BRONZE - 20.000	360.000
1201003	64/6 COLORIS BRONZE - 10.000	360.000
1201005	64/8 COLORIS BRONZE - 10.000	270.000
1201007	64/10 COLORIS BRONZE - 10.000	270.000
1201009	64/12 COLORIS BRONZE - 10.000	180.000
1201011	64/14 COLORIS BRONZE - 10.000	180.000

PAGE		
48		

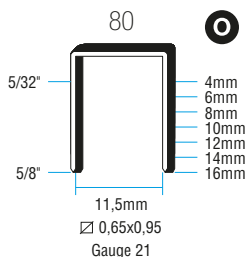

CODE	ARTICLE	PACK
1201103	80/4 COLORIS BRONZE - 10.000	300.000
1201105	80/6 COLORIS BRONZE - 10.000	240.000
1201107	80/8 COLORIS BRONZE - 10.000	180.000
1201109	80/10 COLORIS BRONZE - 10.000	180.000
1201111	80/12 COLORIS BRONZE - 10.000	120.000
1201113	80/14 COLORIS BRONZE - 10.000	120.000
1201117	80/16 COLORIS BRONZE - 10.000	120.000
1201160	80/6 RED EDITION COLORIS BRONZE - 5.000	50.000
1201161	80/8 RED EDITION COLORIS BRONZE - 5.000	50.000
1201162	80/10 RED EDITION COLORIS BRONZE - 5.000	50.000
1201163	80/12 RED EDITION COLORIS BRONZE - 5.000	50.000
1201164	80/14 RED EDITION COLORIS BRONZE - 5.000	50.000
1201165	80/16 RED EDITION COLORIS BRONZE - 5.000	50.000
1201401	80/4 GALVANISÉES - 10.000	200.000
1201403	80/6 GALVANISÉES - 10.000	200.000
1201405	80/8 GALVANISÉES - 10.000	200.000
1201407	80/10 GALVANISÉES - 10.000	100.000
1201409	80/12 GALVANISÉES - 10.000	100.000
1201411	80/14 GALVANISÉES - 10.000	100.000
1201413	80/16 GALVANISÉES - 10.000	100.000
1201901	80/4 INOX - 20.000	240.000
1201903	80/6 INOX - 10.000	240.000
1201905	80/8 INOX - 10.000	180.000
1201907	80/10 INOX - 10.000	180.000
1201909	80/12 INOX - 10.000	120.000
1201911	80/14 INOX - 10.000	120.000
>1111230	RO-MA 80/8 INOX - 1.128	15
> 1111231	RO-MA 80/10 INOX - 940	15
> 1111232	RO-MA 80/14 INOX - 752	15

PAGE		
11	37	41 46 47

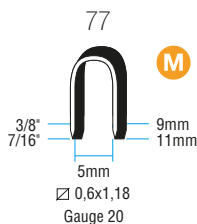

CODE	ARTICLE	PACK
1102001	77/9 ZINGUÉS - 1.000	30.000
1102003	77/11 ZINGUÉS - 1.000	30.000
>1130501	RO-MA 77/9 ZINGUÉS - 1.440	15
>1130503	RO-MA 77/11 ZINGUÉS - 1.152	15

PAGE		
14		

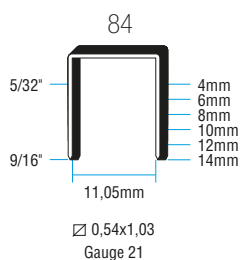

CODE	ARTICLE	PACK
1201201	84/4 COLORIS BRONZE - 10.000	200.000
1201203	84/6 COLORIS BRONZE - 10.000	240.000
1201205	84/8 COLORIS BRONZE - 10.000	180.000
1201207	84/10 COLORIS BRONZE - 10.000	180.000
1201209	84/12 COLORIS BRONZE - 10.000	120.000
1201211	84/14 COLORIS BRONZE - 10.000	120.000

PAGE		
49		

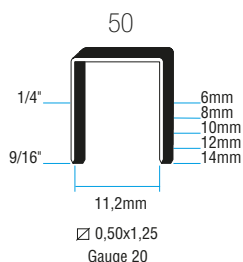

PAGE		
11	41	

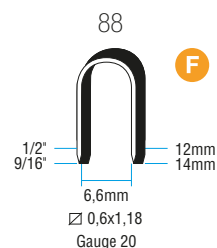

CODE	ARTICLE	PACK
1102005	88/12 ZINGUÉS - 1.000	30.000
1102007	88/14 ZINGUÉS - 1.000	30.000
> 1130505	RO-MA 88/12 ZINGUÉS - 1.152	15
> 1130507	RO-MA 88/14 ZINGUÉS - 864	15

PAGE		
14		

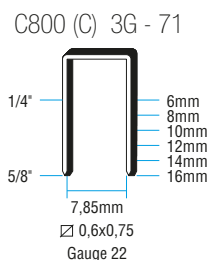

CODE	ARTICLE	PACK
1261104	C 806 ZINGUÉS - 25.000	280.000
1261108	C 808 ZINGUÉS - 28.000	224.000
1261113	C 810 ZINGUÉS - 25.000	200.000
1261116	C 812 ZINGUÉS - 35.000	140.000
1261119	C 814 ZINGUÉS - 32.000	128.000
1261124	C 816 ZINGUÉS - 27.000	108.000

PAGE		
11	41	

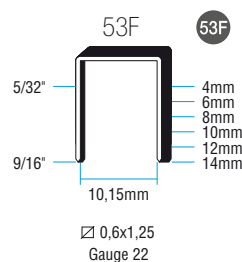

PAGE		
7	23	

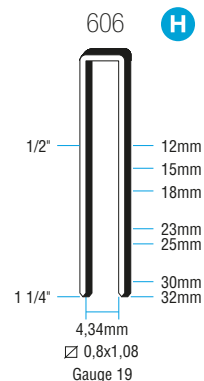
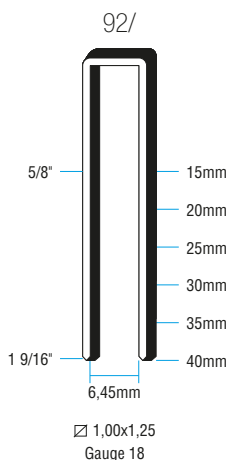
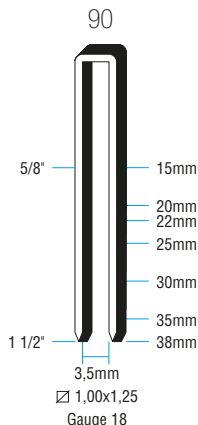

CODE	ARTICLE	PACK
1202001	90/15 COLORIS BRONZE - 5.000	80.000
1202002	90/20 COLORIS BRONZE - 5.000	60.000
1202003	90/22 COLORIS BRONZE - 5.000	50.000
1202005	90/25 COLORIS BRONZE - 5.000	50.000
1202007	90/30 COLORIS BRONZE - 5.000	40.000
1202011	90/35 COLORIS BRONZE - 5.000	40.000
1202013	90/38 COLORIS BRONZE - 5.000	30.000

CODE	ARTICLE	PACK
1202100	92/15 COLORIS BRONZE - 7.000	70.000
1202101	92/20 COLORIS BRONZE - 5.000	60.000
1202103	92/25 COLORIS BRONZE - 4.000	48.000
1202105	92/30 COLORIS BRONZE - 4.000	40.000
1202107	92/35 COLORIS BRONZE - 3.000	30.000
1202109	92/40 COLORIS BRONZE - 3.000	30.000

CODE	ARTICLE	PACK
1202301	M 606/12 ZINGUÉS - 5.000	100.000
1202303	M 606/15 ZINGUÉS - 5.000	100.000
1202307	M 606/23 ZINGUÉS - 5.000	50.000
1202310	M 606/30 ZINGUÉS - 2.200	24.200
1202311	M 606/32 ZINGUÉS - 2.200	24.200
1202317	M 606/18 DP ZINGUÉS - 4.800	57.600
1202319	M 606/23 DP ZINGUÉS - 4.800	57.600
>1110420	RO-MA 606/12 ZINGUÉS - 1.176	15
> 1110422	RO-MA 606/15 ZINGUÉS - 980	15
> 1110424	RO-MA 606/18 ZINGUÉS - 784	15
> 1110426	RO-MA 606/23 ZINGUÉS - 588	15
> 1110428	RO-MA 606/25 ZINGUÉS - 588	15

PAGE	
51	53

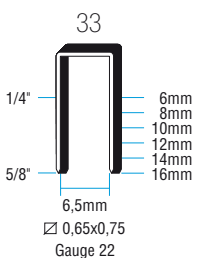

PAGE	
50	

PAGE	
37	41

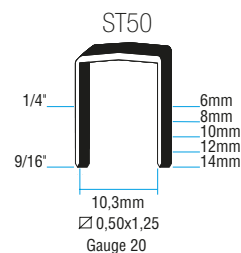
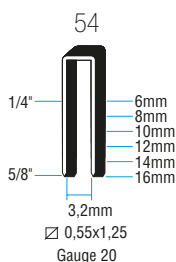
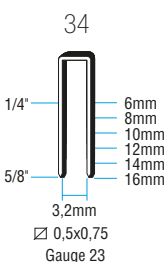

PAGE	
11	

PAGE	
11	41

PAGE	
11	

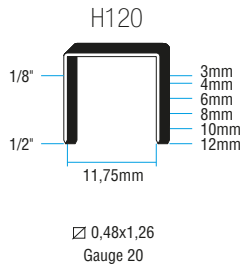

Ø 0,48x1,26
Gauge 20

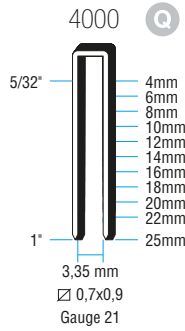

Ø 0,7x0,9
Gauge 21

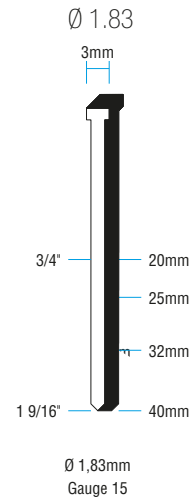

Ø 1.83mm
Gauge 15

CODE	ARTICLE	PACK
1261502	H 123 ZINGUÉS - 10.000	100.000
1261507	H 124 ZINGUÉS - 16.200	97.200
1261515	H 126 ZINGUÉS - 34.000	136.000
1261522	H 128 ZINGUÉS - 30.000	120.000
1261528	H 1210 ZINGUÉS - 8.400	100.800
1261536	H 1212 ZINGUÉS - 14.000	56.000
1261511	H124 INOX - 5.000	260.000
1261518	H126 INOX - 3.000	70.000
1261540	H1212 INOX - 7.000	56.000

PAGE

CODE	ARTICLE	PACK
1201300	4004 COLORIS BRONZE - 20.000	600.000
1201301	4006 COLORIS BRONZE - 20.000	400.000
1201303	4008 COLORIS BRONZE - 20.000	320.000
1201305	4010 COLORIS BRONZE - 10.000	300.000
1201307	4012 COLORIS BRONZE - 10.000	250.000
1201309	4014 COLORIS BRONZE - 10.000	200.000
1201311	4016 COLORIS BRONZE - 10.000	180.000
1201313	4018 COLORIS BRONZE - 10.000	160.000
1201315	4020 COLORIS BRONZE - 10.000	120.000
1201317	4022 COLORIS BRONZE - 10.000	120.000
1201318	4025 COLORIS BRONZE - 10.000	100.000
1201320	4016 DP COLORIS BRONZE - 10.000	100.000
1201322	4020 DP COLORIS BRONZE - 10.000	100.000

PAGE

41

CODE	ARTICLE	PACK
1233149	Ø1.83 - 20 mm 3.000	30.000
1233150	Ø1.83 - 25 mm 3.000	15.000
1233152	Ø1.83 - 32 mm 1.500	15.000
1233153	Ø1.83 - 40 mm 1.500	15.000

PAGE

56

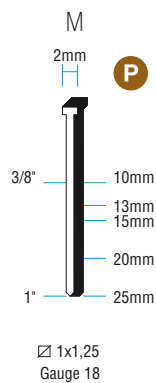

Ø 1x1,25
Gauge 18

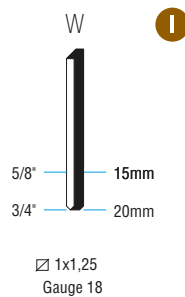

Ø 1x1,25
Gauge 18

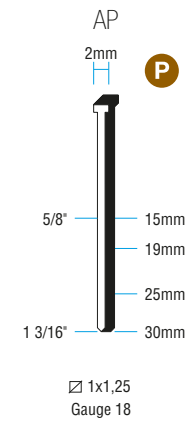

Ø 1x1,25
Gauge 18

CODE	ARTICLE	PACK
>1130800	RO-MA M10 ZINGUÉS - 3.500	15
>1130801	RO-MA M13 ZINGUÉS - 2.500	15
>1130803	RO-MA M15 ZINGUÉS - 1.700	15
>1130805	RO-MA M20 ZINGUÉS - 1.500	15
>1130807	RO-MA M25 ZINGUÉS - 1.200	15

> blister

PAGE

7 9 11 13 17 21 23 25
29 33 35

CODE	ARTICLE	PACK
>1130820	RO-MA W15 ZINGUÉS - 2.000	15
>1130822	RO-MA W20 ZINGUÉS - 2.000	15

> blister

PAGE

11 13 33

CODE	ARTICLE	PACK
1231131	AP15 - 15 mm - 5.000	150.000
1231133	AP19 - 19 mm - 5.000	100.000
1231135	AP25 - 25 mm - 5.000	100.000
1231137	AP30 - 30 mm - 5.000	50.000

PAGE

37 39 41 43

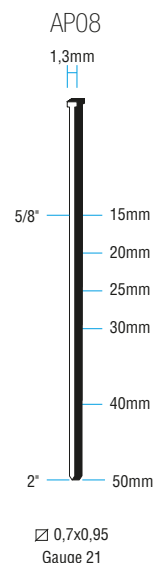
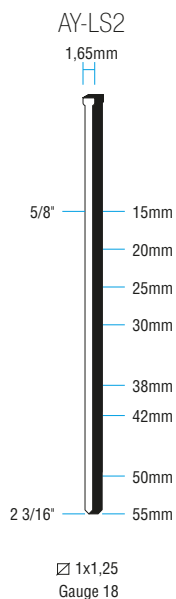
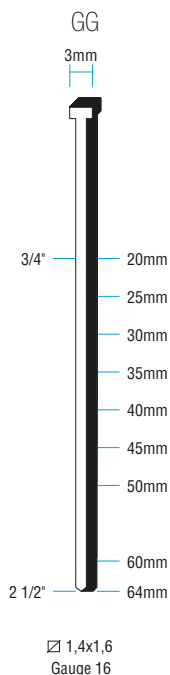

CODE	ARTICLE	PACK
1233100	GG20 - 20 mm - 4.000	80.000
1233101	GG25 - 25 mm - 4.000	64.000
1233103	GG30 - 30 mm - 4.000	48.000
1233105	GG35 - 35 mm - 4.000	48.000
1233107	GG40 - 40 mm - 4.000	32.000
1233109	GG45 - 45 mm - 4.000	32.000
1233111	GG50 - 50 mm - 4.000	32.000
1233120	GG60 - 60 mm - 4.000	32.000
1233121	GG64 - 64 mm - 4.000	32.000

CODE	ARTICLE	PACK
1273301	AY-LS2 15 mm GALVANISÉES - 8.000	128.000
1273303	AY-LS2 20 mm GALVANISÉES - 7.000	112.000
1273305	AY-LS2 25 mm GALVANISÉES - 5.000	80.000
1273307	AY-LS2 30 mm GALVANISÉES - 4.000	64.000
1273309	AY-LS2 38 mm GALVANISÉES - 4.000	64.000
1273311	AY-LS2 42 mm GALVANISÉES - 3.000	48.000
1273313	AY-LS2 50 mm GALVANISÉES - 2.500	40.000
1273315	AY-LS2 55 mm GALVANISÉES - 2.000	32.000

CODE	ARTICLE	PACK
1231301	AP08 - 15 mm - 6.100	61.000
1231303	AP08 - 20 mm - 6.100	61.000
1231305	AP08 - 25 mm - 6.100	61.000
1231307	AP08 - 30 mm - 6.100	61.000
1231309	AP08 - 40 mm - 4.000	40.000
1231310	AP08 - 50 mm - 4.000	40.000

FASTENING

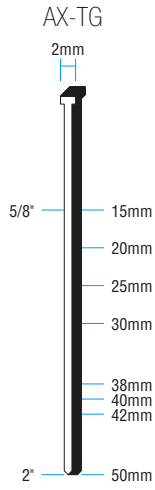

□ 1x1,25
Gauge 18

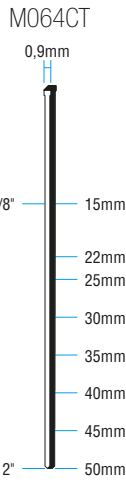

∅ 0,64mm
Gauge 23

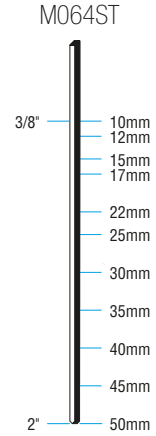

∅ 0,64mm
Gauge 23

CODE	ARTICLE	PACK
1164001	AX-TG 15 mm - 5.000	150.000
1164003	AX-TG 20 mm - 5.000	100.000
1164005	AX-TG 25 mm - 5.000	100.000
1164007	AX-TG 30 mm - 5.000	50.000
1164009	AX-TG 38 mm - 5.000	50.000
1164011	AX-TG 40 mm - 5.000	50.000
1164012	AX-TG 42 mm - 6.000	36.000
1164014	AX-TG 50 mm - 5.000	50.000

PAGE

53 54 55 57

CODE	ARTICLE	PACK
1234120	M064CT 15 mm - 20.000	480.000
1234122	M064CT 22 mm - 20.000	320.000
1234124	M064CT 25 mm - 20.000	320.000
1234126	M064CT 30 mm - 10.000	240.000
1234127	M064CT 35 mm - 10.000	180.000
1234128	M064CT 40 mm - 10.000	180.000
1234129	M064CT 45 mm - 10.000	180.000
1234130	M064CT 50 mm - 10.000	120.000

PAGE

58 59

CODE	ARTICLE	PACK
1234101	M064ST 10 mm - 30.000	240.000
1234103	M064ST 12 mm - 20.000	360.000
1234105	M064ST 15 mm - 20.000	360.000
1234107	M064ST 17 mm - 20.000	360.000
1234109	M064ST 22 mm - 10.000	180.000
1234111	M064ST 25 mm - 10.000	180.000
1234113	M064ST 30 mm - 10.000	180.000
1234114	M064ST 35 mm - 10.000	240.000
1234115	M064ST 40 mm - 10.000	180.000
1234116	M064ST 45 mm - 10.000	180.000
1234117	M064ST 50 mm - 10.000	120.000

PAGE

58 59

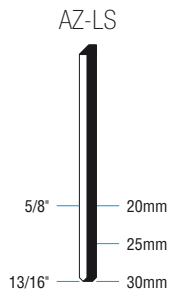

□ 1x1,25
Gauge 18

CODE	ARTICLE	PACK
1271117	AZ-LS 20 mm GALVANISÉES - 8.000	128.000
1271121	AZ-LS 25 mm GALVANISÉES - 7.000	112.000
1271123	AZ-LS 30 mm GALVANISÉES - 6.000	96.000

PAGE

57

6/AN

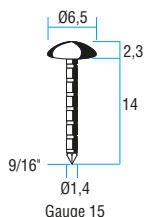

CODE	ARTICLE	PACK
1292102	6/AN LAITONNÉ - 4.000	36.000
1292103	6/AN NICKELÉ - 4.000	36.000
1292107	6/AN LAITON NOYER - 4.000	36.000
1292108	6/AN LAITONNÉS NOIX DÉSAMORCÉS - 4.000	36.000
1292110	6/AN SANS NICKEL - 4.000	36.000
1292111	6/AN SANS NICKEL LAITON ROUGE - 4.000	36.000
1292112	6/AN LAITON BRUNI - 4.000	36.000
1292129	6/AN LAITON ROUGE - 4.000	36.000
1292115	6/AN LAITON ROUGE NOIR - 4.000	36.000
1292120	6/AN FUMÉ - 4.000	36.000
1292104	6/AN LAITON ANCIEN - 4.000	36.000
1292106	6/AN BRAS NICKELÉ 10 mm - 4.000	36.000
1292109	6/AN VIEIL OR BRILLANT - 4.000	36.000
1292114	6/AN BRAS SANS NICKEL 10 mm - 4.000	36.000
1292116	6/AN BRAS LAITONNÉ NOYER 10 mm - 4.000	36.000
1292126	6/AN NICKEL ANCIEN - 4.000	36.000

PAGE

63

6/GL

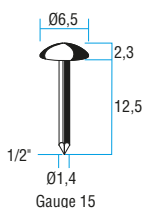

CODE	ARTICLE	PACK
1292012	6/GL LAITON DÉSAMORCÉ - 4.000	36.000
1292013	6/AN LAITONNÉS NOIX DÉSAMORCÉS - 4.000	36.000
1292001	6/GL FUMÉ - 4.000	36.000
1292002	6/GL LAITONNÉ - 4.000	36.000
1292003	6/GL NICKELÉS - 4.000	36.000
1292009	6/GL LAITON NOYER - 4.000	36.000
1292010	6/GL SANS NICKEL - 4.000	36.000
1292025	6/GL LAITON ROUGE - 4.000	36.000
1292011	6/GL SANS NICKEL LAITON ROUGE - 4.000	36.000
1292015	6/GL LAITON BRUNI - 4.000	36.000
1292004	6/GL VIEIL OR - 4.000	36.000
1292027	6/GL SANS LAITON - 4.000	36.000

PAGE

63

6/AN TÊTE PLATE

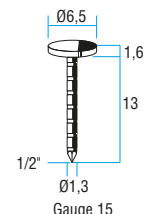

CODE	ARTICLE	PACK
1292140	6/AN LAITONNÉ TÊTE PLATE - 4.000	36.000
1292142	6/AN TÊTE PLATE VIEILLIE EN LAITON 10 mm - 4.000	36.000
1292143	6/AN NICKELÉ TÊTE PLATE - 4.000	36.000

PAGE

63

7S/AN

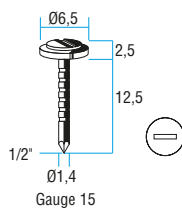

CODE	ARTICLE	PACK
1292151	7S/AN LAITONNÉ TÊTE À VIS - 4.000	36.000
1292153	7S/AN NICKELÉ TÊTE À VIS - 4.000	36.000
1292157	7S/AN SANS NICKEL TÊTE À VIS - 4.000	36.000
1292158	7S/AN SANS LAITON TÊTE À VIS - 4.000	36.000

PAGE

63

7S/AN - SCR

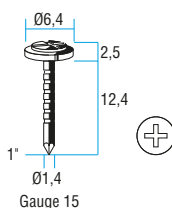

CODE	ARTICLE	PACK
1292154	7S/AN LAITONNÉ TÊTE À VIS SCR - 4.000	36.000

PAGE

63

FASTENING

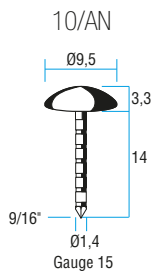

CODE	ARTICLE	PACK
1292501	10/AN LAITONNÉ - 2.000	18.000
1292502	10/AN NICKELÉ - 2.000	18.000
1292510	10/AN LAITON ROUGE - 2.000	18.000
1292506	10/AN FUMÉ - 2.000	18.000
1292508	10/AN LAITON ANCIEN - 2.000	18.000
1292509	10/AN DORÉ VEILLI BRILLANT - 2.000	18.000
1292549	10/AN LAITON NOIX - 2.000	18.000
1292580	10/AN SANS NICKEL - 2.000	18.000

PAGE

63

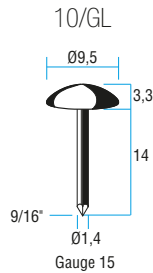

CODE	ARTICLE	PACK
1292401	10/GL LAITONNÉ - 2.000	18.000
1292402	10/GL NICKELÉ - 2.000	18.000
1292405	10/GL DORÉ ANCIEN - 2.000	18.000
1292410	10/GL VIEIL OR MARTELÉ - 2.000	18.000
1292412	10/GL FUMÉ - 2.000	18.000
1292403	10/GL NOIRE - 2.000	18.000
1292404	10/GL BRUEN - 2.000	18.000

PAGE

63

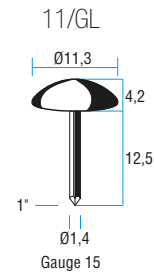

CODE	ARTICLE	PACK
1292603	11/GL DORÉ VEILLI BRILLANT - 1.333	12.000
1292817	11/GL DORÉ ANCIEN - 1.333	12.000
1292818	11/GL LAITONNÉS DÉSAMORCÉS - 1.333	12.000
1292819	11/GL LAITON ANCIEN - 1.333	12.000
1292815	11,5/GL FUMÉ - 1.333	12.000
1292810	11,5/GL NATURAL - 1.333	12.000
1292811	11,5/GL OXFORD - 1.333	12.000
1292812	11,5/GL FRENCH NATURAL - 1.333	12.000
1292813	11,5/GL NICKEL - 1.333	12.000
1292814	11,5/GL LAITONNÉ - 1.333	12.000
1292816	11,5/GL NOIRE - 1.333	12.000

PAGE

63

FRAMING

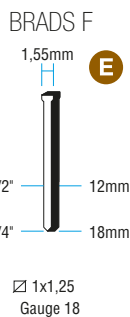

CODE	ARTICLE	PACK
1160205	F18 ZINGUÉ - 5.000/20.000	100.000
> 1130840	RO-MA F12 ZINGUÉS - 2.000	15
> 1130830	RO-MA F18 ZINGUÉS - 2.000	15

PAGE

66 67 68 69

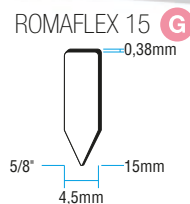

CODE	ARTICLE	PACK
1299056	ROMAFLEX 15 - 5.000	80.000
> 1130901	ROMAFLEX 15 - 2.080	15

PAGE

70 71

PACKAGING

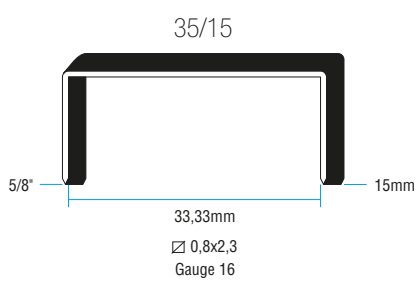

CODE	ARTICLE	PACK
1107001	35/15 CUIVRÉS - 2.500	25.000

PAGE					
74	75	76	77	80	81

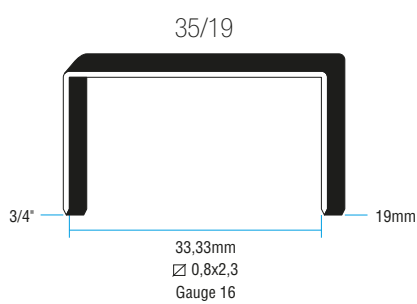

CODE	ARTICLE	PACK
1107005	35/19 CUIVRÉS - 2.000	20.000
1107007	35/19 CUIVRÉS NEUTRES - 2.000	20.000

PAGE					
74	75	76	77	80	81

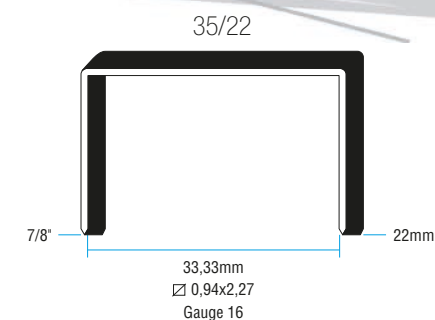

CODE	ARTICLE	PACK
1211205	35/22 CUIVRÉS - 1.500	15.000

PAGE			
74	75	80	81

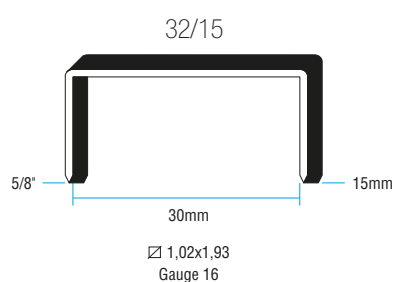

CODE	ARTICLE	PACK
1211103	32/15 CUIVRÉS - 2.000	20.000

PAGE					
------	--	--	--	--	--

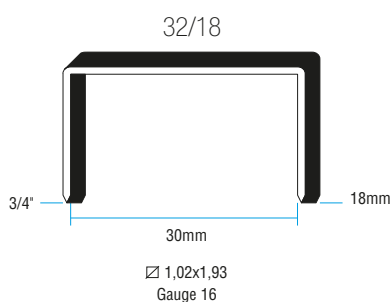

CODE	ARTICLE	PACK
1211105	32/18 CUIVRÉS - 2.000	20.000

PAGE					
------	--	--	--	--	--

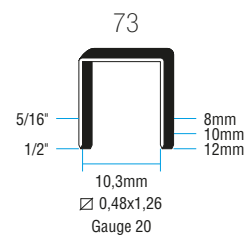

CODE	ARTICLE	PACK
1101810	73/8 ZINGUÉS - 5.000	80.000
1101811	73/10 ZINGUÉS - 5.000	70.000
1101812	73/12 ZINGUÉS - 5.000	60.000

PAGE					
79					

PACKAGING

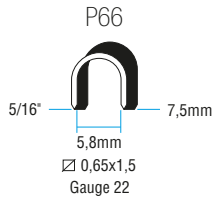

CODE	ARTICLE	PACK
1213005	P66 ZINGUÉS - 5.000	100.000

PAGE

613 M (moyen)

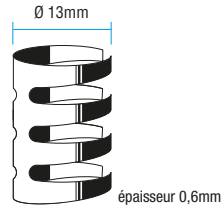

CODE	ARTICLE	PACK
> 1291109	613 M - 10.000 pcs	100.000

> exécution avec légende effectué pour 500.000 pièces demander devis

PAGE

613 P (lourd)

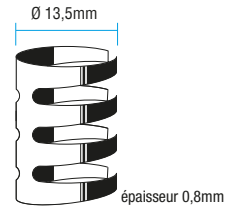

CODE	ARTICLE	PACK
> 1291110	613 P - 10.000 pcs	100.000

> exécution avec légende effectué pour 500.000 pièces demander devis

PAGE

617 L (léger)

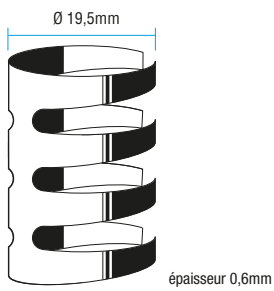

CODE	ARTICLE	PACK
> 1291131	617 L - 12.000 pcs	48.000

> exécution avec légende effectué pour 500.000 pièces demander devis

PAGE

617 P (lourd)

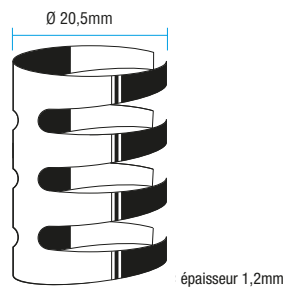

CODE	ARTICLE	PACK
> 1291139	617 P - 12.000 pcs	48.000

> exécution avec légende effectué pour 500.000 pièces demander devis

PAGE

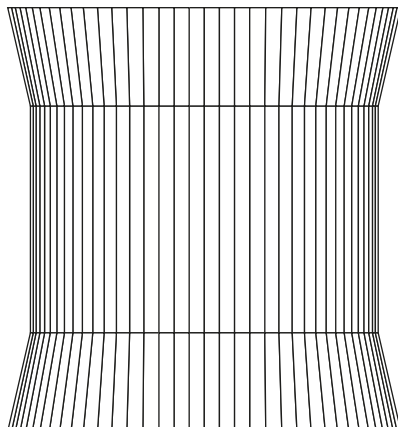

M15/A - M19/A

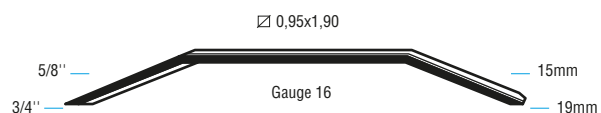

CODE	ARTICLE	PACK
1299978	M15/A CUIVRÉS - 1.000	24.000
1299977	M19/A CUIVRÉS - 1.000	24.000

PAGE

78

MATÉRIAUX CONSOMMABLES

SCELLÉS POUR FEUILLARDS EN MÉTAL



PACKAGING

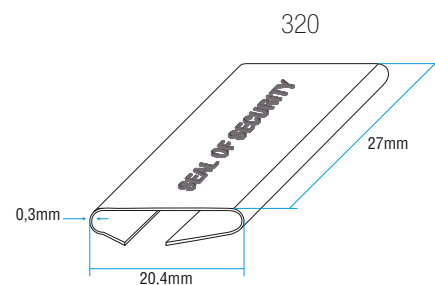
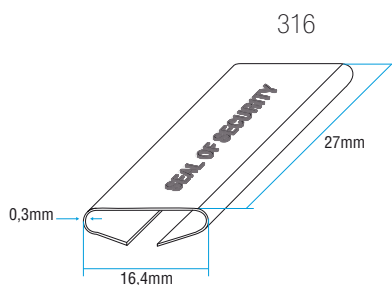
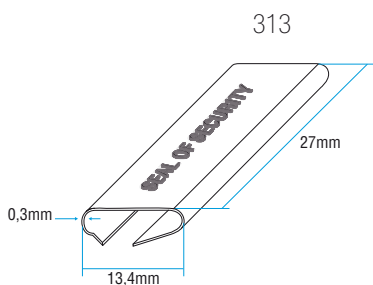

CODE	ARTICLE	PACK
1190120	313 ACIER - NEUTRES	3.000
> 1190121	313 ACIER AVEC LÉGENDE	2.000

> exécution avec légende effectué pour 50.000 pièces

PAGE		
85		

CODE	ARTICLE	PACK
1190132	316 ACIER - NEUTRES	3.000
> 1190133	316 ACIER AVEC LÉGENDE	3.000

> exécution avec légende effectué pour 50.000 pièces

PAGE		
85		

CODE	ARTICLE	PACK
1190152	320 ACIER - NEUTRES	3.000
> 1190153	320 ACIER AVEC LÉGENDE	2.000

> exécution avec légende effectué pour 50.000 pièces

PAGE		
85		

FEUILLARD EN MÉTAL

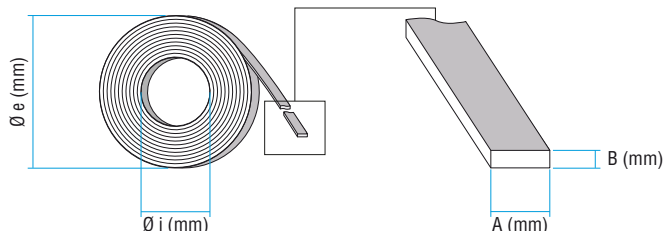

CODE	ARTICLE			i	Ø e	PACK (kg)
	A	B	FINITION			
1192115	13 x 0.50		BRILLANTE	300 mm - 550 mm		30
1192125	16 x 0.50		BRILLANTE	300 mm - 550 mm		35
1192135	18 x 0.60		BRILLANTE	300 mm - 550 mm		40
1192145	20 x 0.60		BRILLANTE	300 mm - 550 mm		25
1290415	25 x 1.00		BRILLANTE	300 mm - 550 mm		30
1290423	30 x 1.00		BRILLANTE	300 mm - 550 mm		40
1290431	32 x 1.00		BRILLANTE	300 mm - 550 mm		40
1192127	16 x 0.50		BLEUTÉE - HAUTE RÉSIDENCE	300 mm - 550 mm		60
1192137	19 x 0.60		BLEUTÉE - HAUTE RÉSIDENCE	300 mm - 550 mm		75
1192136	19 x 0.60		ZINGUÉE	300 mm - 550 mm		30
1192148	20 x 0.60		ZINGUÉE	300 mm - 550 mm		25
1192139	19 x 0.60		ZINGUÉE PEINTE	300 mm - 550 mm		35

PAGE						
85	86	87				

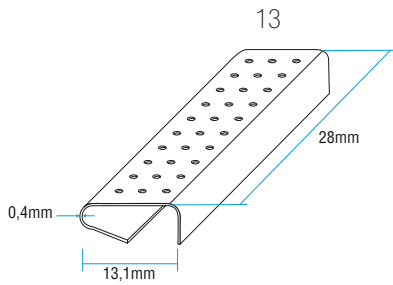

CODE	ARTICLE	PACK
> 1190006	13 LA BOULONNÉS	2.500
<i>> exécution avec légende effectué pour 50.000 pièces demander devis</i>		
PAGE		
91		

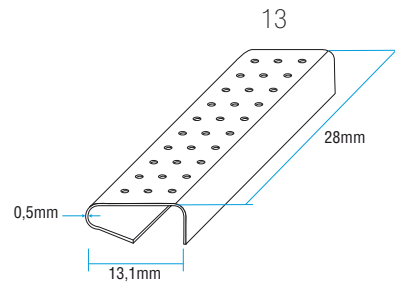

CODE	ARTICLE	PACK
> 1190010	13 PA BOULONNÉS	2.500
<i>> exécution avec légende effectué pour 50.000 pièces demander devis</i>		
PAGE		
91		

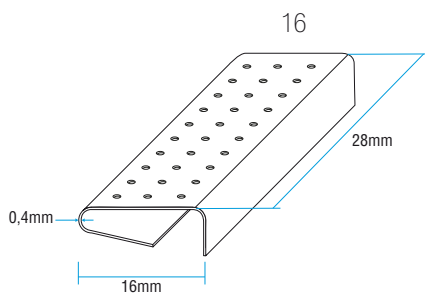

CODE	ARTICLE	PACK
> 1190021	16 LA BOULONNÉS	2.000
<i>> exécution avec légende effectué pour 50.000 pièces demander devis</i>		
PAGE		
91		

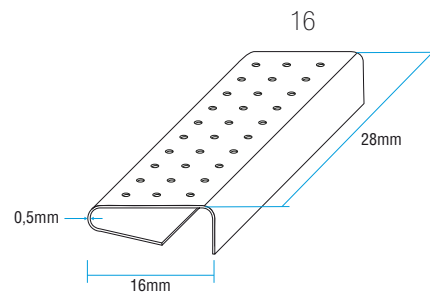

CODE	ARTICLE	PACK
> 1190023	16 PA BOULONNÉS	2.000
<i>> exécution avec légende effectué pour 50.000 pièces demander devis</i>		
PAGE		
91		

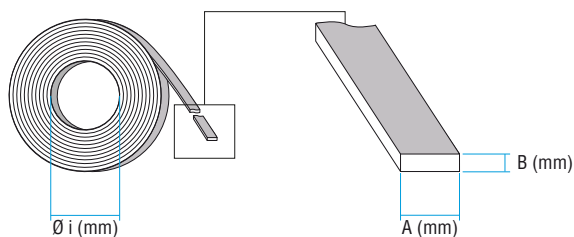

CODE	ARTICLE				Ø i	PACK (m)
	A	B	COULEUR			
1191105	12	0.50	NOIRE	PP	60 mm	4.000
1191107	12	0.60	NOIRE	PP	60 mm	4.000
1191108	12	0.80	NOIRE	PP	60 mm	3.800
1191121	15	0.50	NOIRE	PP	60 mm	3.600
1191125	15	0.60	NOIRE	PP	60 mm	3.600
1191128	15	0.80	NOIRE	PP	60 mm	3.200
1191151	12	0.50	NOIRE	PP	400 mm	3.000
1191153	12	0.60	NOIRE	PP	400 mm	2.500
1191155	12	0.80	NOIRE	PP	400 mm	2.000
1191173	15	0.50	NOIRE	PP	400 mm	2.000
1191175	15	0.60	NOIRE	PP	400 mm	2.000
1191177	15	0.80	NOIRE	PP	400 mm	1.500
1191179	15	0.80	BLANCHE	PP	400 mm	1.500

PAGE

91

92

93

94

95

FEUILLARD EN PLASTIQUE THERMOUSOUDABLE

CODE	ARTICLE				Ø i	PACK (m)
	A	B	COULEUR			
1290306	6	0.50	BLANCHE	PP	200 mm	4.800
1290304	9	0.50	BLANCHE	PP	200 mm	4.000
1290305	9	0.60	BLANCHE	PP	200 mm	3.500
1290308	12	0.50	BLANCHE	PP	200 mm	3.000
1290307	12	0.58	BLANCHE	PP	200 mm	3.000
1290312	12	0.60	BLANCHE	PP	200 mm	2.500
1290311	12	0.60	NOIRE	PP	200 mm	3.000
1290317	12	0.80	NOIRE	PP	200 mm	2.000
1290313	12	0.60	BLANCHE	PP	280 mm	2.500
1290315	12	0.60	BLANCHE	PP	400 mm	2.500
1290320	12	0.80	BLANCHE	PP	400 mm	2.000
1290319	12	0.80	NOIRE	PP	400 mm	2.000
1290323	15	0.60	NOIRE	PP	400 mm	2.000
1290325	15	0.80	NOIRE	PP	400 mm	1.500
1290329	12	0.60	VERT	PET	400 mm	2.500
1290330	15	0.60	VERT	PET	400 mm	2.000
1290326	15	0.80	VERT	PET	400 mm	1.500
1290328	19	0.90	VERT	PET	400 mm	1.000

PAGE

91

92

93

94

95

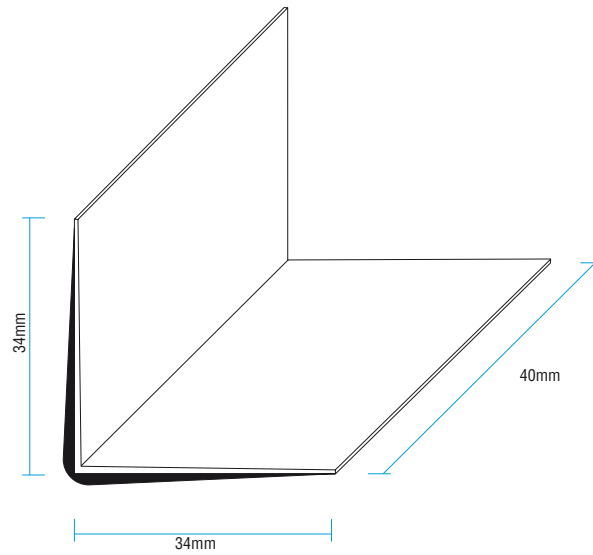

CODE	ARTICLE	PACK
1290130	4X4 ANGULAIRES MOYENNES	4.000

PAGE

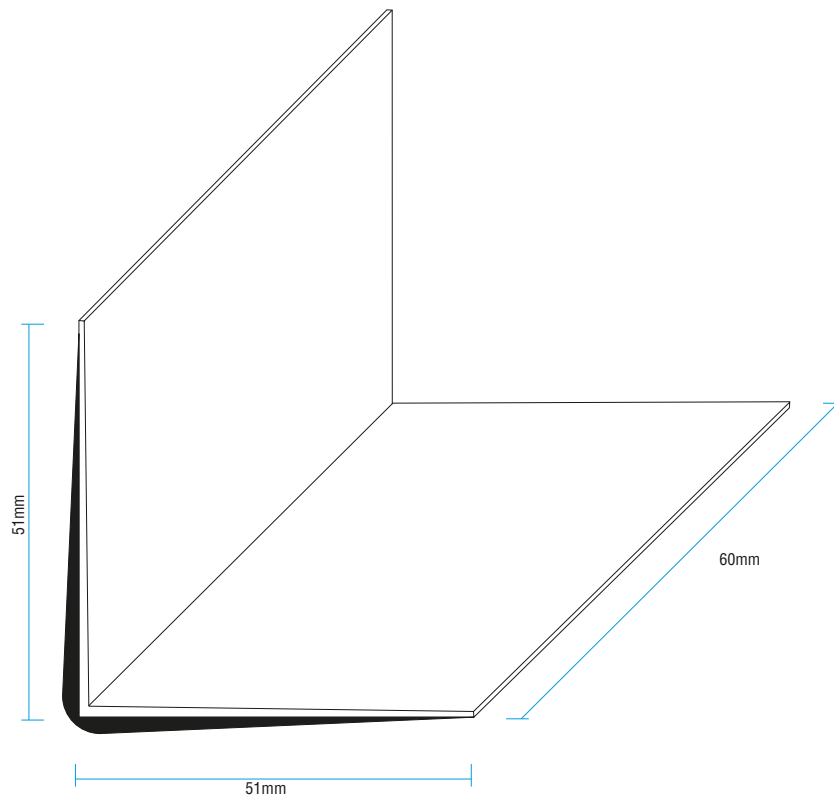

CODE	ARTICLE	PACK
1290132	6X6 ANGULAIRES GRANDES	1.000

PAGE



depuis 1919

dans les systèmes de fixation



romeo maestri & figli s.p.a.

sistemi di cucitura a punto metallico - système d'agrafage métallique

via Milano, 5 - 20007 Cornaredo (MI) - Italy

tel +39 02.93619.1

www.romeomaestri.com - sales@romeomaestri.it

