

# GENERAL CATALOGUE

-  **Fastening Line**
-  **Framing Line**
-  **Packaging Line**



*a history of Tradition  
and Excellence*

**Fastening Line**



**METAL MANUAL TACKERS**

ROCAMA 10	4
ROCAMA JR 4.0	6
ROCAMA 14 4.0	8
ROCAMA 16	10
ROCAMA 20	12
M77 - M88	14

**HEAVY DUTY HAMMER TACKERS**

MART 13 - MART 50	15
-------------------	----

**PLASTIC MANUAL TACKERS**

ROMA 10	16
ROMA 14	17
TECNICA 8	18
TECNICA 10	19
TECNICA 14	20
ROMATAK 10 4.0	22
ROMATAK 14 4.0	24



**BATTERY-POWERED CORDLESS TACKERS**

ROCAMATICA	28
------------	----



**ELECTRIC TACKERS**

ECOTAK	32
ELECTRO	34
LKT	36
ME	40

**ELECTRIC BRAD NAILERS**

LKT 30	38
ME 30	42



**PNEUMATIC TACKERS**

RO-MA 8016	46
RO-MA 8016BL	47
RO-MA 6414	48
RO-MA 8414	49
RO-MA 9240	50
RO-MA 9025	51
RO-MA 90 COMBI	52

**PNEUMATIC FINISH NAILERS**

RO-MA 30TG	54
RO-MA 50TG	55
RO-MA 50 CONCRETE	56
RO-MA 55 MULTIBRAD	57
RO-MA 30/64	58
RO-MA 35/64	59
RO-MA 30/08	60
RO-MA 45/08	61

**PNEUMATIC STUD NAILERS**

PN/2	62
------	----

**Framing Line**

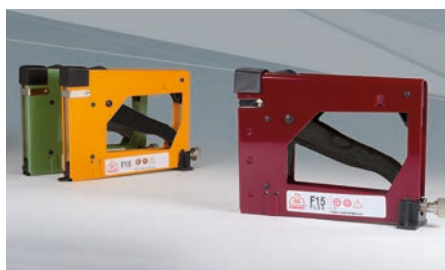

**MANUAL FRAME NAILERS/FLEXITABS**

F12	66
F18	68
F15 FLEX	70

**PNEUMATIC FRAME NAILERS/FLEXITABS**

FP12	67
FP18	69
FP15 FLEX	71

**Packaging Line**



**MANUAL CARTON CLOSING MACHINES**

ROAMA MANUAL	74
ELPABOX BH	76
GF135 MECCANICA	80

**PNEUMATIC CARTON CLOSING MACHINES**

ROAMA PNEUMATIC	75
ELPABOX BA	77
RI-19/A	78
GF135 PNEUMATICA	81

**STAPLING PLIER FOR MEDIUM THICKNESS**

RO-MA 73	79
----------	----



**MANUAL STRAPPING TOOLS**

MULTENS	84
B051	86
BAND-IT C001	88
FA/PLAST - MPL	90

**BATTERY POWERED STRAPPING TOOLS**

TB 1216	92
TB 1620	93

**DISPENSER FOR STEEL AND PLASTIC STRAPS**

320 - M13-32	87
M4000 - PR/P	94

**PACKAGING KIT FOR STRAPPING**

EASY PACK	95
-----------	----



**GLUE GUNS**

MINIGRIP 7H	98
GRIP 11H	99
GRIP 15HL	100
GRIP 18HP	101
GRIP 20XP	102
M 195	103
M 220	104
M 3350	105
M 812	106
M812 MG	107
M12 / M7 / H12 / L12	108

**Consumables**

FASTENING	110
FRAMING	118
PACKAGING	119

ROCAMA 10	4
ROCAMA JR 4.0	6
ROCAMA 14 4.0	8
ROCAMA 16	10
ROCAMA 20	12
M77 - M88	14
MART 13 - MART 50	15
ROMA 10	16
ROMA 14	17
TECNICA 8	18
TECNICA 10	19
TECNICA 14	20
ROMATAK 10 4.0	22
ROMATAK 14 4.0	24







# ROCAMA 10

## METAL MANUAL TACKERS

Special aluminium alloy body. Bottom loading. Ergonomic grip. Frame and picture construction. For decoration

work. To secure upholstery, sofa and furniture coverings. Ideal for all types of paper and fabric, for stand set-up,

store furnishing, home, trailer and camper interiors.

### Metal Black

Adjustment power device.



Snap-on belt attachment.



Available in:



 MADE in ITALY

CODE	ARTICLE		PACK
0104112	ROCAMA 10 METAL BLACK Mod. 107 S/A	Forest	5
0104110	ROCAMA 10 METAL BLACK Mod. 110 S/A	Forest-AP	5
0104113	ROCAMA 10 METAL BLACK Mod. 53 S/A	53/	5
0104111	ROCAMA 10 METAL BLACK Mod. 110/13 S/A	Forest-AP/13	5
> 0104310	ROCAMA 10 METAL BLACK Mod. 110 C/A	Forest-AP	5
> 0104311	ROCAMA 10 METAL BLACK Mod. 110/13 C/A	Forest-AP/13	5

> version with nozzle



**ROCAMA 10 S/A**  
(without nozzle)



Available in 4 models.

**Mod. 107 S/A**



**Mod.110 S/A**

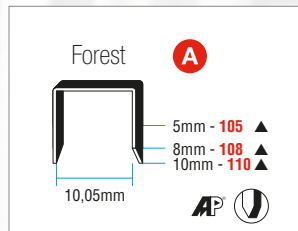

▲ Also available in AP version

**Mod. 53 S/A**

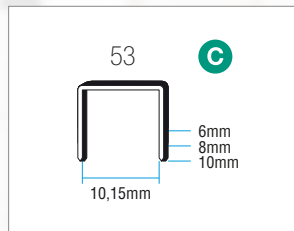

**Mod. 110/13 S/A**

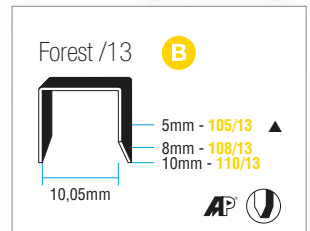

▲ Also available in AP version

**ROCAMA 10 C/A**  
(with nozzle)



Available in 2 models.

**Mod.110 C/A**

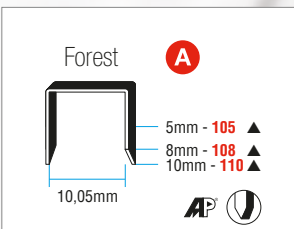

▲ Also available in AP version

**Mod. 110/13 C/A**

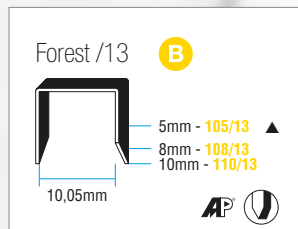

▲ Also available in AP version





## METAL MANUAL TACKERS

Compact, handy, robust.  
Very powerful.  
Maximum driving power  
with minimum effort.

Bottom loading.  
Wooden chassis  
and frame assembly.

Upholstery, sofa  
and furniture coverings.  
Secure all types of  
paper and fabric.

### Metal Black

Non-slip rubber handle.



#### 4 in 1.

Four different types of staples and metal nails are used with no need for adjustment.

Handle lock.



Available in:



CODE	ARTICLE					PACK
0101040	ROCAMA JR 4.0 Mod. 110	Forest-AP	53/	13/	M10	10
0101041	ROCAMA JR 4.0 Mod. 110/13	Forest-AP/13	50F/	53F/	M10	10



Available in 2 models.

### Mod. 110

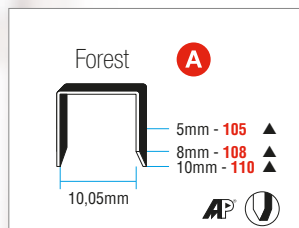

▲ Also available in AP version

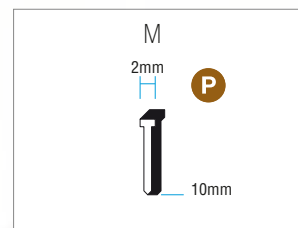
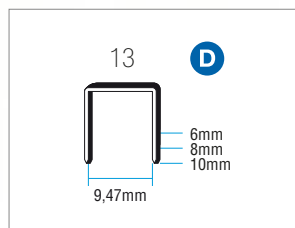
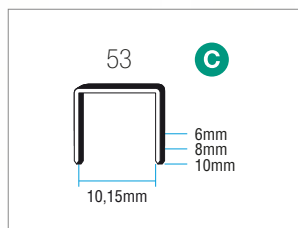

### Mod. 110/13

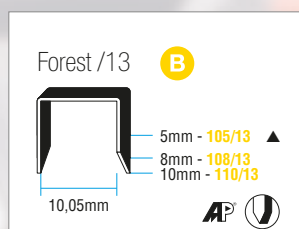

▲ Also available in AP version

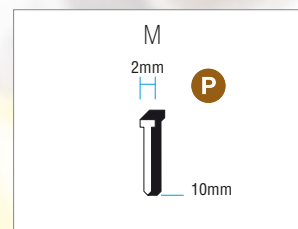
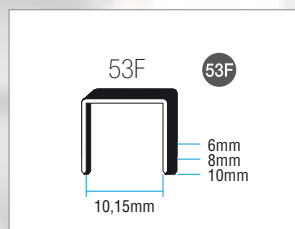
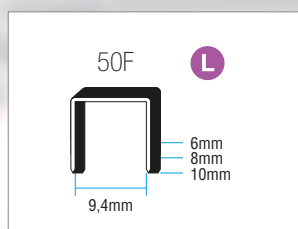

**FOREST®** **AP®** **M53** **M50F** **M13** **CHIODINI M**

Original Maestri staple use recommended  
Page 110, 111, 112, 114

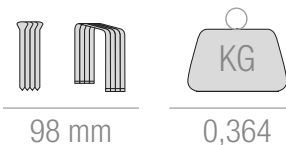

## METAL MANUAL TACKERS

Frame and picture construction, decoration works. To secure upholstery, sofa and furniture

coverings. To secure all types of paper and fabric, wooden plinths and profiles, for stand set-up, store

furnishing, home, trailer and camper interiors.

### Metal Black

Adjustment power device.



Non-slip rubber handle.



4 in 1.

Four different types of staples and metal nails are used with no need for adjustment.

Handle lock.



Available in:



CODE	ARTICLE					PACK
0104530	ROCAMA 14 4.0 Mod. 114	AP-Forest	53/	13/	M15	5



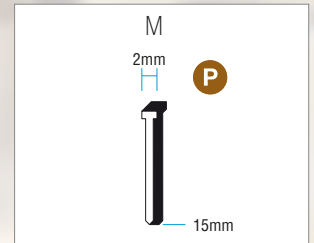
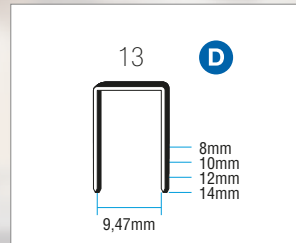
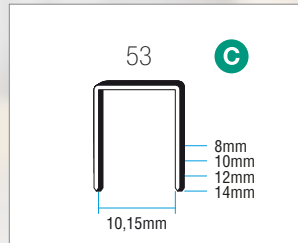
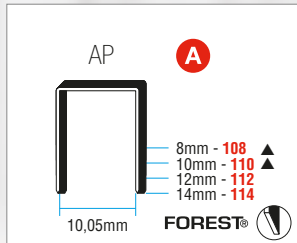

▲ Also available in the FOREST version

**FOREST®** **AP®** **M53** **M13** **CHIODINI M**

Original Maestri staple use recommended  
 Page 110, 111, 114

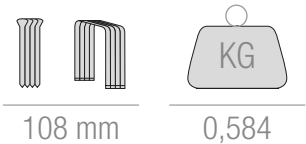

## METAL MANUAL TACKERS

Compact, handy, robust.  
Very powerful.  
Maximum driving power with  
minimum effort.

Decoration works, upholstery, plinths, etc. Secure all types  
of paper and fabric.  
woodworking, insulation,  
tongue and groove ceilings,  
wooden panels, raceways,

### Metal Black

Adjustment power device.



Removable front plate.

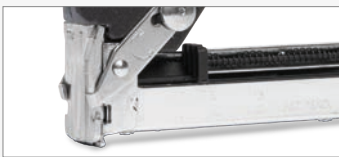

3 in 1.

Three different types of staples and nails are used in the same tacker with no need for adjustment.

Handle lock.



Available in:



CODE	ARTICLE				PACK
0105001	ROCAMA 16 METAL BLACK Mod. 116B	AP-Forest	M13-15	W15	5
0105003	ROCAMA 16 METAL BLACK Mod. 53.16B	53/	M13-15	W15	5
0105005	ROCAMA 16 METAL BLACK Mod. 13.14	13/			5
0105225	ROCAMA 16 METAL BLACK Mod. 80.16	80/			5
> 0105004	ROCAMA 16 METAL BLACK Mod. 50F	50F/			5
> 0105210	ROCAMA 16 METAL BLACK Mod. 71	C800 (C) 3G - 71			5
> 0105232	ROCAMA 16 METAL BLACK Mod. 54	54/			5
> 0105227	ROCAMA 16 METAL BLACK Mod. 34	34/			5
> 0105229	ROCAMA 16 METAL BLACK Mod. 50	50/			5
> 0105214	ROCAMA 16 METAL BLACK OUTWARD CLINCH	ST50/			5
> 0105216	ROCAMA 16 METAL BLACK Mod. ST.50	ST50/			5

> special version on request

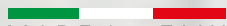
 MADE in ITALY





Available in 11 models.

**Mod. 116B**

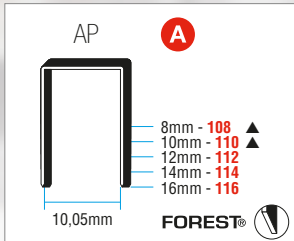

▲ Also available in the FOREST version

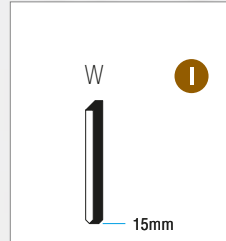
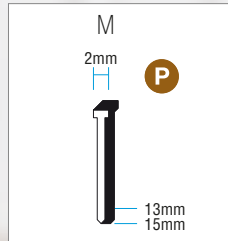

**Mod. 53.16B**

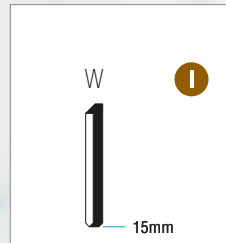
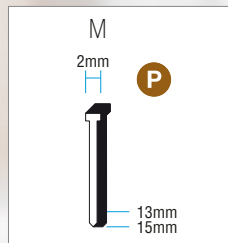
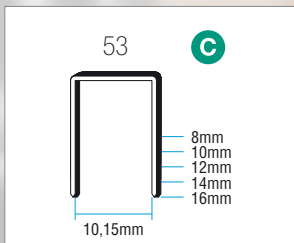

**Mod. 13.14**

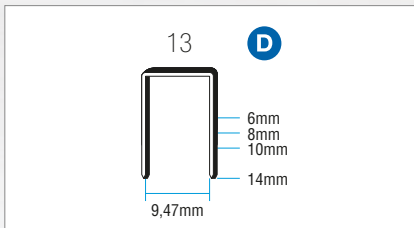

**Mod. 80.16**

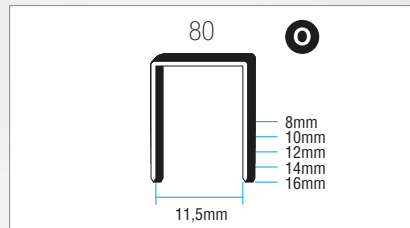

**Mod. 50F**

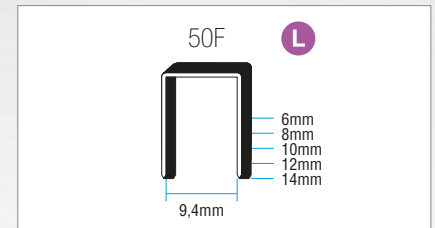

**Mod. 71**

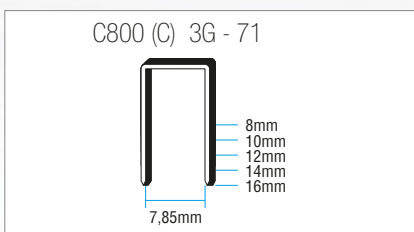

**Mod. 54**

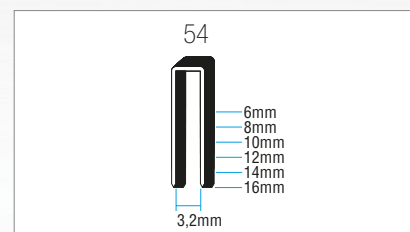

**Mod. 34**

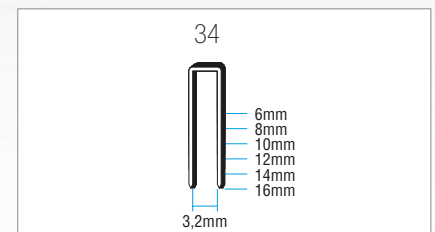

**Mod. 50**

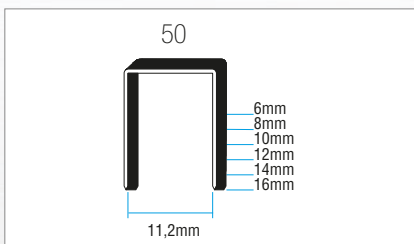

**Mod. ST50**

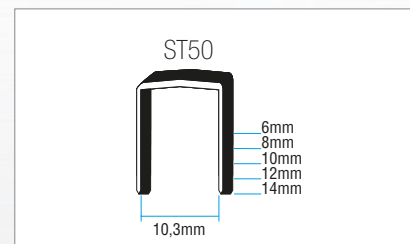

**Mod. OUTWARD CLINCH**

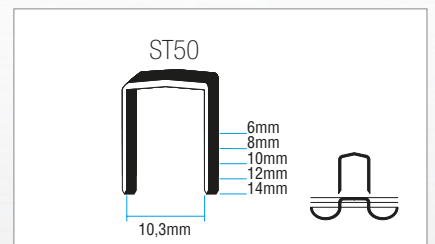

**FOREST® AP M53 M50F M13 80 CHIODINI W-M**

Original Maestri staple use recommended  
Page 110, 111, 112, 113, 114

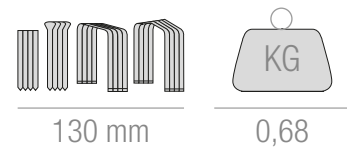

130 mm

0,68

## METAL MANUAL TACKERS

Compact, handy, robust.  
Very powerful.  
Maximum driving power with  
minimum effort.

Decoration works, upholstery, plinths, etc. Secure all types  
of paper and fabric.  
woodworking, insulation,  
tongue and groove ceilings,  
wooden panels, raceways,

### Metal Black

Adjustment power device.



Removable front plate.

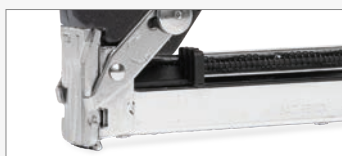

3 in 1.

Three different types of staples and nails are used in the  
same tacker with no need for  
adjustment.

Handle lock.



Available in:

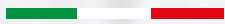

CODE	ARTICLE				PACK
0105503	ROCAMA 20 METAL BLACK Mod. 120B	AP-Forest	M20	W20	5
0105501	ROCAMA 20 METAL BLACK Mod. 53/20B	53/	M20	W20	5

 MADE in ITALY



Available in 2 models.

### Mod. 120B

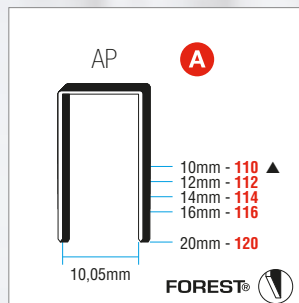

▲ Also available in the FOREST version

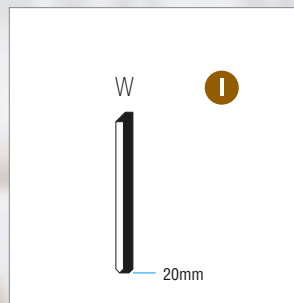
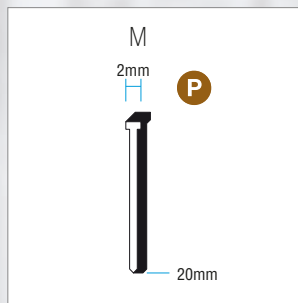

### Mod. 53/20B

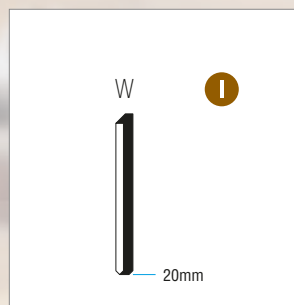
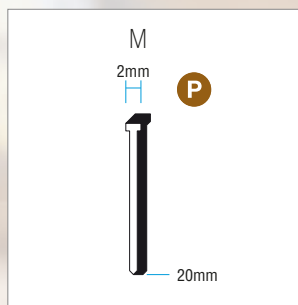
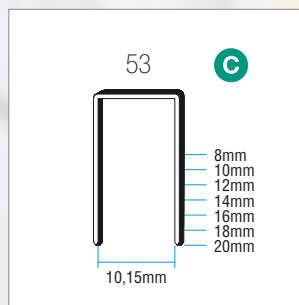

**FOREST®** **AP®** **M53** **CHIODINI W-M**

Original Maestri staple use recommended  
Page 110, 111, 114

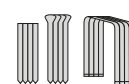

130 mm



0,69

## M77 - M88

Manual chrome-plated steel tacker with insulated plastic coated handle.

Ideal to tack Ø 5 mm (M77) and Ø 6,5 mm (M88) television and telephone cables.

Anatomic rubber grip.



Handle lock.



Available in:



CODE	ARTICLE		PACK
0121301	M 77	77/	4
0121302	M 88	88/	4



Available in 2 models.

Mod. M 77

Mod. M 88

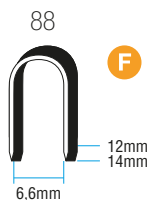
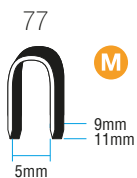

**77/ 88/**

Original Maestri staple use recommended  
Page 112

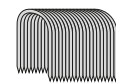

120 mm



KG

0,85



# HEAVY DUTY HAMMER TACKERS



*Hammer tacker  
for staples, designed to be  
used to secure insulation,*

*roofing, tar paper, crate  
labels, fruit mesh  
and crates.*

## MART 13 MART 50

CODE	ARTICLE		PACK
0190162	<b>MART 13</b>	13/	6
0190160	<b>MART 50</b>	50F/	4



**Mod. MART 13**

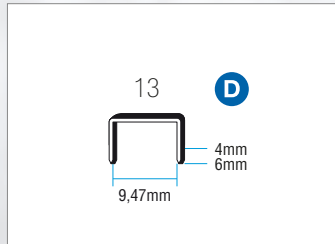

Available in:



**Mod. MART 50**

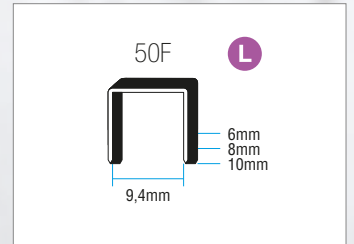

Available in:



**M13**



124 mm



KG

0,40

Original Maestri staple use recommended  
Page 111

**M50F**



210 mm



KG

0,98

Original Maestri staple use recommended  
Page 111

## ROMA 10

For decoration work. To secure upholstery, sofa and furniture coverings. Secure all types of paper and fabric. Upholster chairs and decorate windows. Store furnishing. Bottom loading.

ABS body.



Handle lock.



Available in:



CODE	ARTICLE		PACK
0112025	ROMA 10	53/	8

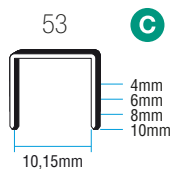

**M53**

Original Maestri staple use recommended  
Page 111

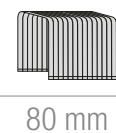

# ROMA 14

For decoration work. To secure upholstery, sofa and furniture coverings. Secure all types of paper and fabric. Upholster chairs and decorate windows.

Comfortable and ergonomic grip. Bottom loading. Stand-by position for the handle. To secure plinths, wooden profiles, panels.

CODE	ARTICLE			PACK
0114023	ROMA 14	53/	M15	8

ABS body.



Adjustment power device.



Available in:

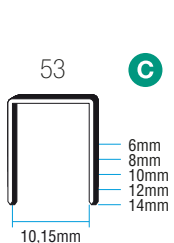

## M53 CHIODINI M

Original Maestri staple use recommended  
Page 111, 114

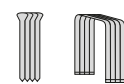

105 mm



0,42



## TECNICA 8

For decoration works and to secure upholstery, sofa and furniture coverings. To secure all types of paper and fabric, cover chairs and decorate windows. Bottom loading.

High impact body in ABS  
20% reinforced fibre glass.



Handle lock.



Available in:



CODE	ARTICLE	PACK
0112010	TECNICA 8 Mod. 108	Forest-AP 10

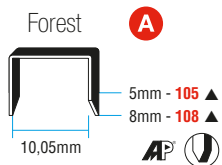

▲ Also available in AP version

**FOREST®** | **AP®**

Original Maestri staple use recommended  
Page 110, 111



80 mm



KG

0,33



CODE	ARTICLE		PACK
0113086	<b>TECNICA 10 Mod. 110</b>	Forest-AP	10
0113087	<b>TECNICA 10 Mod. 110/13</b>	Forest-AP/13	10

High impact body in ABS  
20% reinforced fibre glass.



Handle lock.



Available in:



Available in 2 models.

**Mod. 110**

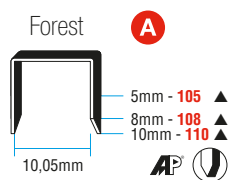

**Mod. 110/13**

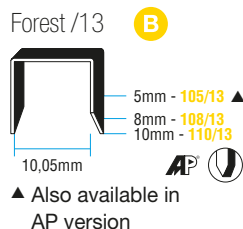

**FOREST® AP®**

Original Maestri staple use recommended  
Page 110, 111



100 mm



0,43

## PLASTIC MANUAL TACKERS

*For decoration work. To secure upholstery  
Secure all types of paper and fabric.*

*Upholster chairs and decorate windows. To secure plinths, wooden profiles, panels.*

*Bottom loading.*

High resistance body in nylon 30% reinforced fibre glass.



Adjustment power device.



Handle lock.



Available in:



CODE	ARTICLE			PACK
0114002	<b>TECNICA 14 Mod. 114</b>	AP-Forest	M15	10
0114003	<b>TECNICA 14 Mod. 53.14</b>	53/	M15	10



Available in 2 models.

**Mod. 114**

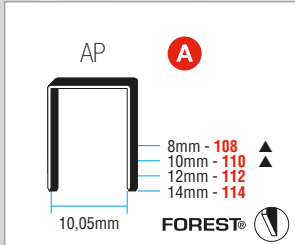

▲ Also available in the FOREST version

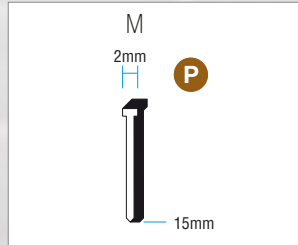

**Mod. 53.14**

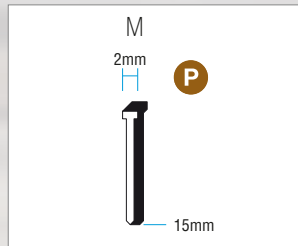
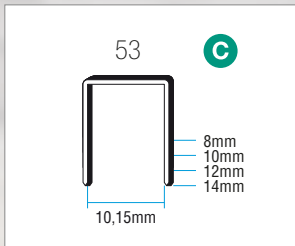

**FOREST® AP® M53 CHIODINI M**

Original Maestri staple use recommended  
Page 110, 111, 114

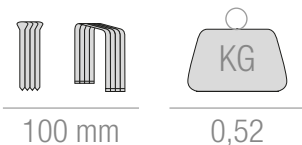



## ROMATAK 10 4.0

Compact, handy, robust.  
Very powerful.  
Maximum driving power  
with minimum effort.

Wooden Frame and picture  
costruction. Decoration  
works, upholstery, sofa and  
furniture coverings.

Secure all types of paper  
and fabric.

### 4 in 1.

Four different types of staples and metal nails are used with no need for adjustment.

High resistance body in nylon  
30% reinforced fibre glass.



### Handle lock.



### Available in:



CODE	ARTICLE					PACK
0113095	ROMATAK 10 4.0 Mod. 110	Forest-AP	53/	13/	M10	10
0113096	ROMATAK 10 4.0 Mod. 110/13	Forest-AP/13	50F/	53F/	M10	10





Available in 2 models.

### Mod. 110

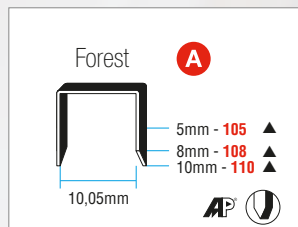

▲ Also available in AP version

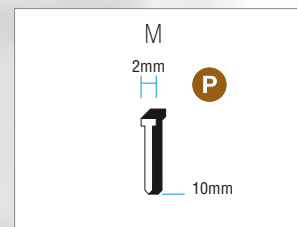
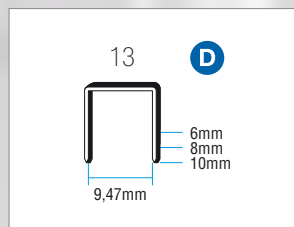
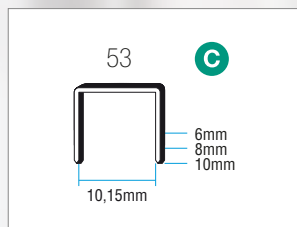

### Mod. 110/13

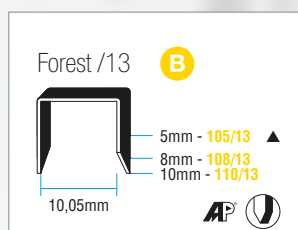

▲ Also available in AP version

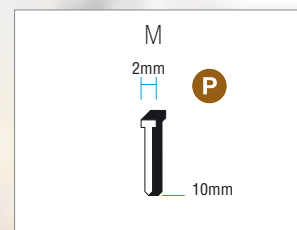
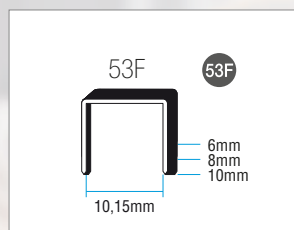
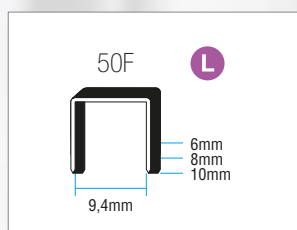

**FOREST®** | **AP®** | **M53** | **M50F** | **M13** | **CHIODINI M**

Original Maestri staple use recommended  
Page 110, 111, 112, 114



98 mm



0,248

## ROMATAK 14 4.0

Compact, handy, robust.  
Very powerful.  
Maximum driving power  
with minimum effort.

Wooden Frame and picture  
costruction. Decoration  
works, upholstery, sofa and  
furniture coverings.

Secure all types of paper  
and fabric.

### 4 in 1.

Four different types of staples and metal nails are used with no need for adjustment.

Adjustment power device.



Handle lock.



Available in:



CODE	ARTICLE					PACK
0114011	ROMATAK 14 4.0 Mod. 114	AP-Forest	53/	13/	M15	10



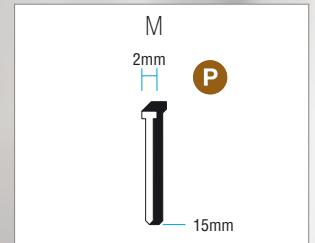
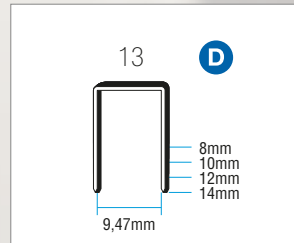
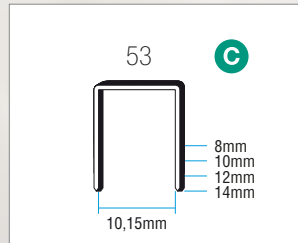
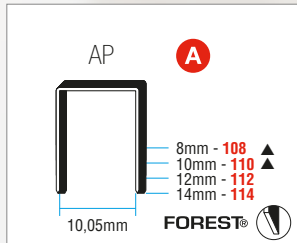

▲ Also available in the FOREST version

FOREST® **AP** M53 M13 CHIODINI M

Original Maestri staple use recommended  
Page 110, 111, 114

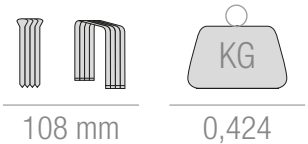





BATTERY-POWERED CORDLESS TACKERS



Lightweight and compact cordless tacker. Designed with a rechargeable battery with lithium technology,

integrated in the body of the tool, which guarantees a long life. Plastic shell built in high-resistant

technopolymer. Convenient carriage button for quick and easy bottom loading. Ideal for DIY and



**3.7V**  
Li-ION BATTERY  
TECHNOLOGY

Non-slip rubber grip and Adjustment power device.



Safety trigger.



LED work light.



Specifications:

Noise: LwA 80,1 dBA  
LpA 69,1 dBA

Vibrations: 1,018 m/s<sup>2</sup>

Available in:



included:

- ▶ 5.000 staples 108 Forest
- ▶ 1 Battery charger
- ▶ 1 Charging cable
- ▶ 1 Protective goggles

Compliant with directives:

- ▶ ROHS
- ▶ 2006/42/CE



CODE	ARTICLE			PACK
0130001	ROCAMATICA Mod. 114	AP-Forest	M15	1



for all fastening work:  
decorations, assembling  
frames, upholstery, covering  
furniture and sofas,

installing insulation, setting  
up exhibition stands, for  
the interiors of caravans,  
campers and boats.

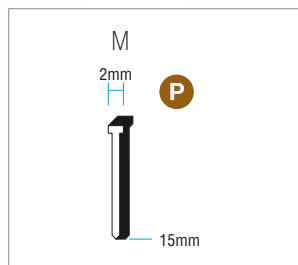
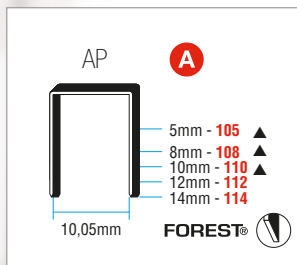

▲ Also available in the FOREST version



**FOREST®** **AP®** **CHIODINI M**

Original Maestri staple use recommended  
Page 110, 111, 114



110 mm



LITHIUM BATTERY  
3,7V 2000mAh



1,05

ECOTAK	32
ELECTRO	34
LKT	36
LKT 30	38
ME	40
ME 30	42







Fast, lightweight, robust, advanced electronics, patented safety system. Adaptable grip for different

uses. Frame and picture construction. Decoration works. To secure upholstery, sofa and furniture

coverings. Insulation installations. Stand set-up and store furnishing. Trailer, camper and boat interiors.

### Hi-Tech ELECTRONIC

Tecno-polymer body.



#### Specifications:

Noise: LpA 73,9 dBA  
LwA 85 dBA

Vibrations: 5,17 m/s<sup>2</sup>

Available in:



Compliant with directives:

- ▶ ROHS
- ▶ 2006/42/CE



CODE	ARTICLE				PACK
0140301	<b>ECOTAK Mod. 114 B</b>	AP-Forest	M15	W15	1
0140001	<b>ECOTAK Mod. 53.14 B</b>	53/	M15	W15	1

MADE in ITALY



Available in 2 models.

**Mod. 114B**

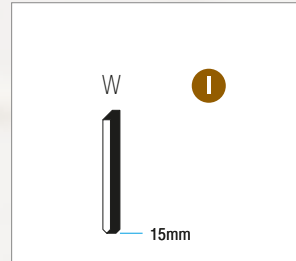
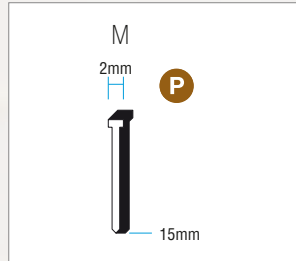
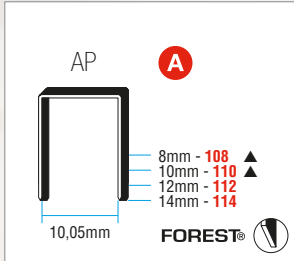

▲ Also available in the FOREST version

**Mod. 53.14B**

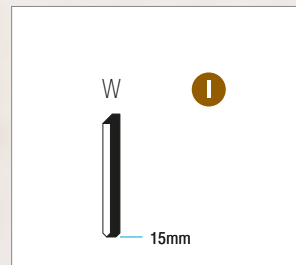
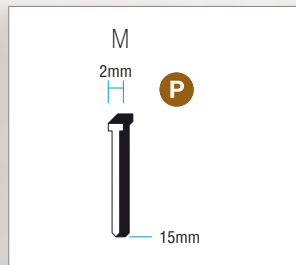
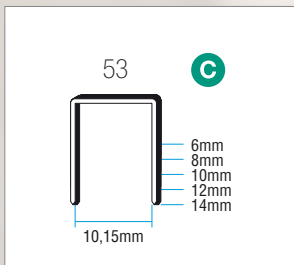

2,5m / 98" electric cable. Available plugs:



**FOREST® AP M53 CHIODINI W-M**

Original Maestri staple use recommended  
Page 110, 111, 114

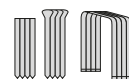

110 mm



AC220/240V  
50-60 Hz



0,83



## ELECTRIC TACKERS

*Fast, light, strong. High-resistant technopolymer shell. Equipped with on/off switch and shot*

*power adjustment knob. Bottom loading. Ideal for all fastening applications such as decorations, stand*

*fittings, frame assemblies, fixtures and upholstery. Interior of caravans, campers, boats.*

### Hi-Tech ELECTRONIC

Safety lock with feeler.



Non-slip rubber grip.



Power adjustment knob.



Specifications:

Noise: LwA 95,8 dBA  
LpA 84,8 dBA

Vibrations: 2,929 m/s<sup>2</sup>

Available in:



Compliant with directives:

- ▶ ROHS
- ▶ 2006/42/CE



CODE	ARTICLE			PACK
0140404	ELECTRO 53.14	53/	M15	1





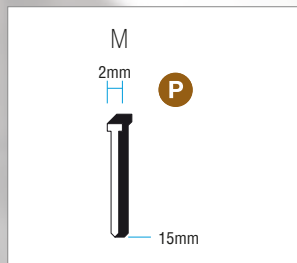
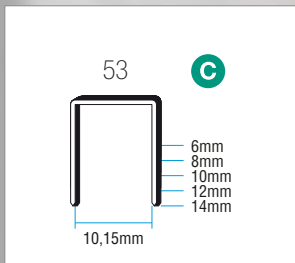

## M53 CHIODINI M

Original Maestri staple use recommended  
Page 111, 114



110 mm



AC220/240V  
50 Hz

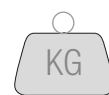

0,650

## ELECTRIC TACKERS

Lightweight, fast, powerful. Chassis and frame construction. Decoration works. Upholstery, sofa

and furniture coverings. Insulation installations. Stand set-up and store furnishing. Trailer, camper

and boat interiors. Built-in rear loading. Safety mechanism to prevent accidental firing shots.

### Extreme PROFESSIONAL

Safety trigger and removable front plate.



Non-slip rubber grip.



High resistance body in nylon 30% reinforced fibre glass.



Specifications:

Noise: LwA 91,5 dBA  
LpA 80,7 dBA

Vibrations: 4,96 m/s<sup>2</sup>

Available in:



Compliant with directives:

- ▶ ROHS
- ▶ 2006/42/CE



CODE	ARTICLE			PACK
0141232	LKT Mod. 120	AP-Forest	AP19	1
0141234	LKT Mod. 53	53/	AP19	1
0141236	LKT Mod. 80 Brad	80/	AP19	1
0141238	LKT Mod. 13	13/		1
0141242	LKT Mod. 50F	50F/		1
0141240	LKT Mod. 4/606 COMBI	606/	AP 15-19-25	1

MADE in ITALY



Designed to work on finished products. Does not leave any support imprint.

Available in 6 models.

### Mod. 120

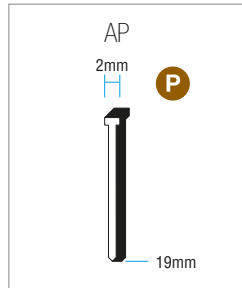
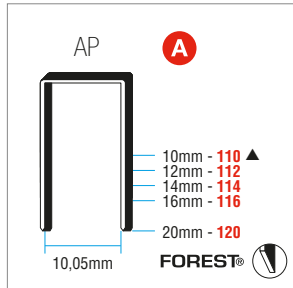

▲ Also available in the FOREST version

### Mod. 53

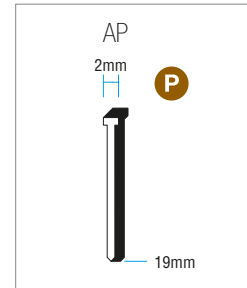
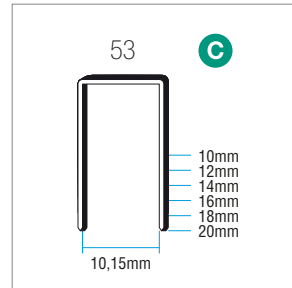

### Mod. 80 Brad

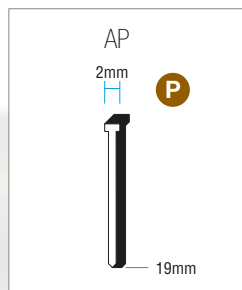
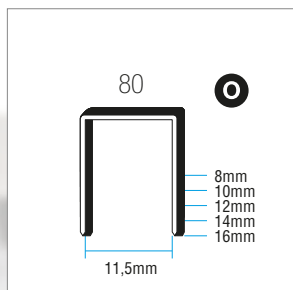

### Mod. 13

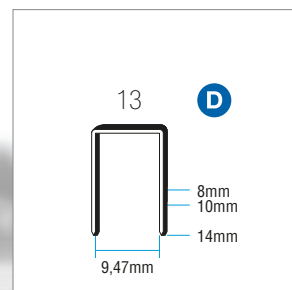

### Mod. 4/606 COMBI

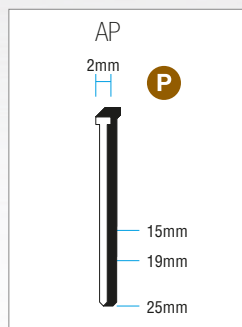
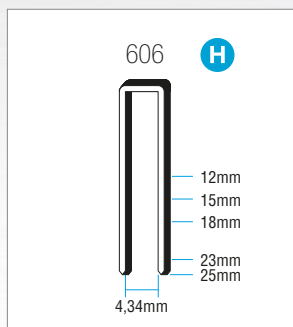

### Mod. 50F

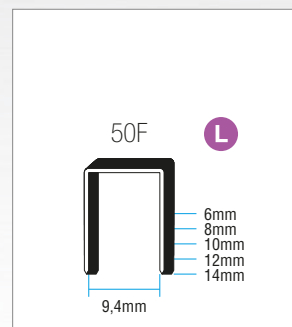

3,5m / 138" electric cable. Available plugs:



**FOREST® AP® M53 80 M13 M50F 606**

Original Maestri staple use recommended  
Page 110, 111, 112, 113, 114

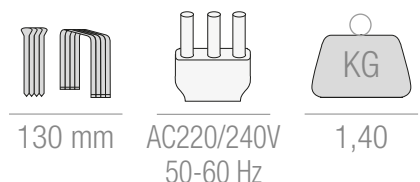

*Lightweight, fast, powerful. Specifically designed to work on finished products without leaving any*

*support imprint. Special for door and window frame installers, tongue and groove sliding, etc.*

*For soft and hard wood.*

### Extreme PROFESSIONAL

Safety trigger and removable front plate.



Non-slip rubber grip.



High resistance body in nylon 30% reinforced fibre glass.



Specifications:

Noise: LpA 82,9 dBA  
LwA 94 dBA

Vibrations: 4,92 m/s<sup>2</sup>

Available in:



Compliant with directives:

- ▶ ROHS
- ▶ 2006/42/CE



CODE	ARTICLE	PACK
0145110	LKT 30	AP 15-19-25-30 1

MADE in ITALY





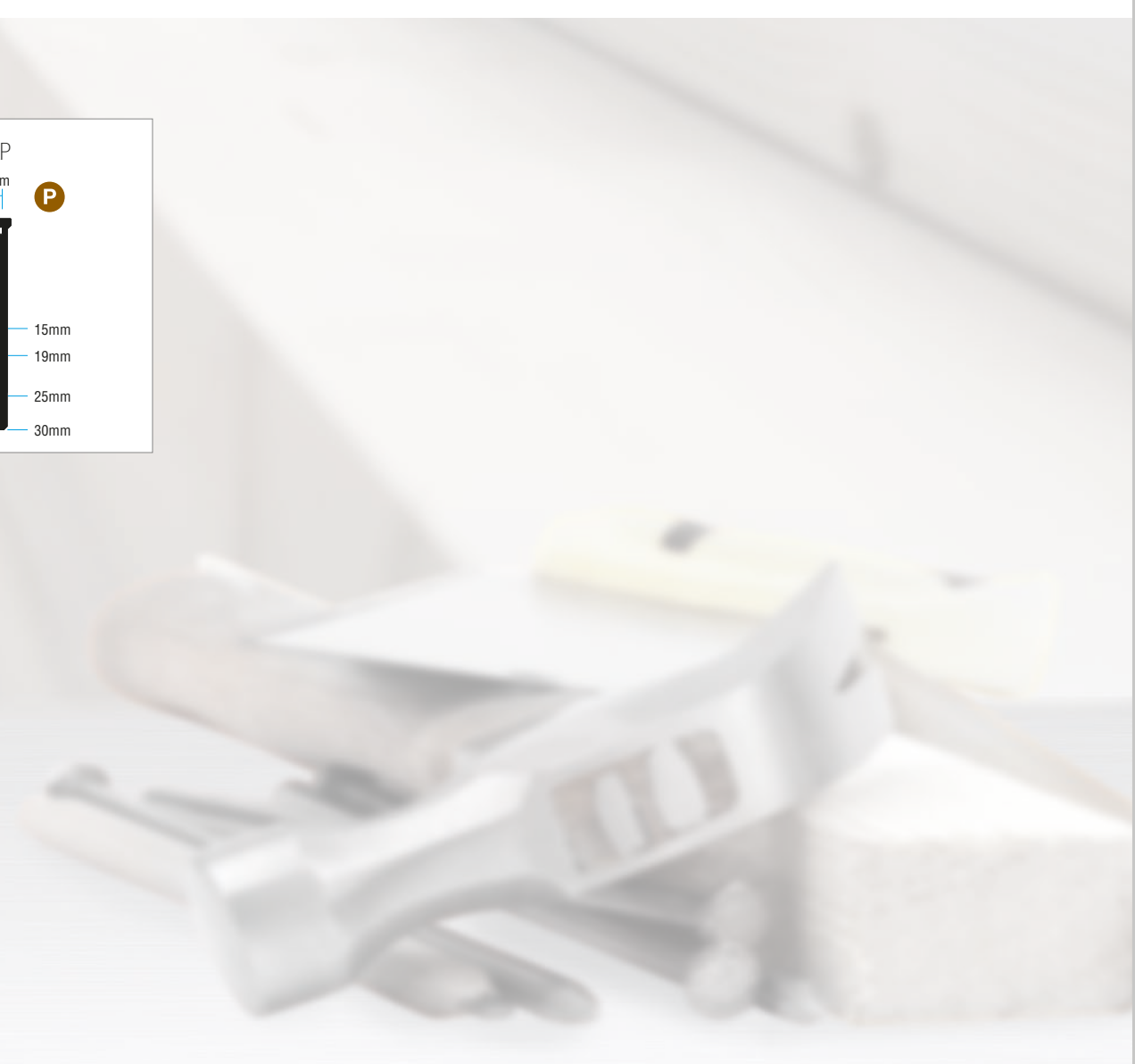
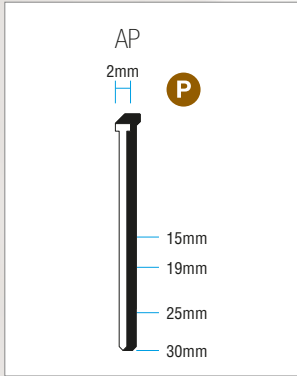

3,5m / 138" electric cable. Available plugs:



Original Maestri staple use recommended  
Page 114



130 mm



AC220/240V  
50-60 Hz



KG

1,40

## ELECTRIC TACKERS

Professional tool ideal for frame, picture construction and wall upholstery assembly.

Decoration work and furniture repairs. To secure frames on furniture and walls,

casings and tongue and groove ceilings. Stand set-up, store furnishing.

### Extreme PROFESSIONAL

Safety trigger and removable front plate.



High resistance body in nylon 30% reinforced fibre glass.



#### Specifications:

Noise: LwA 91,5 dBA  
LpA 80,7 dBA

Vibrations: 4,96 m/s<sup>2</sup>

Available in:



Compliant with directives:

- ▶ ROHS
- ▶ 2006/42/CE



CODE	ARTICLE			PACK
0211113	ME80	80/		1
0211150	ME80 BRAD	80/	AP19	1
0211130	ME4000	4000/		1
0212110	ME 606	606/	AP 15-19-25	1
0211114	ME80 - 110V	80/		1
0213305	ME3G - 110V	C800 (C) 3G - 71		1
0211140	ME54 - 110V	54/		1
0141011	ME50F - 110V	50F/		1
0211136	ME50 - 110V	50/		1

MADE in ITALY



Available in 9 models.

Mod. 80

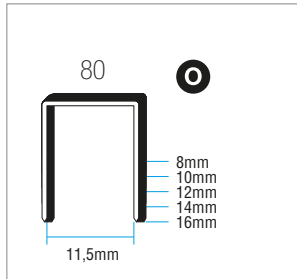

Mod. 50F

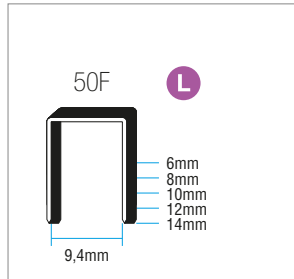

Mod. 4000

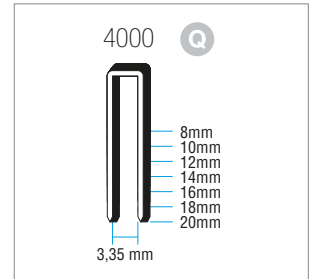

Mod. 80 Brad

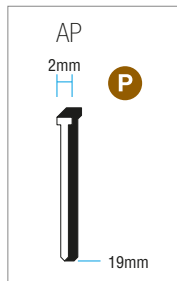
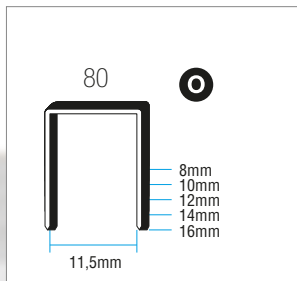

Mod. 3G

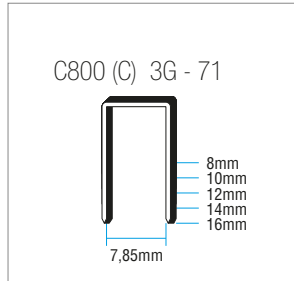

Mod. 54

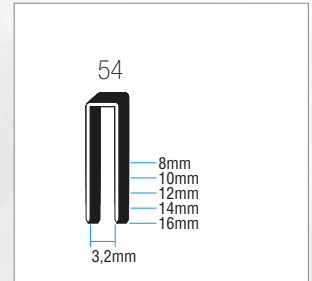

Mod. 606

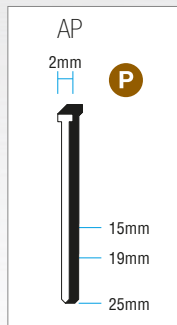
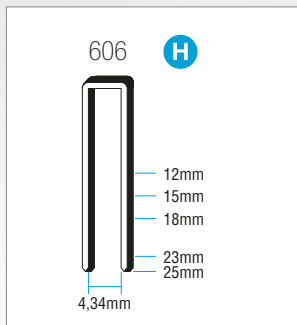

Mod. 50

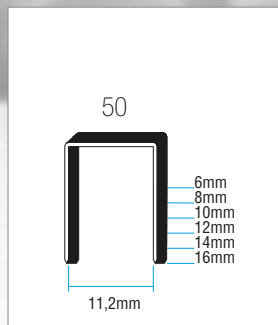

Mod. 33

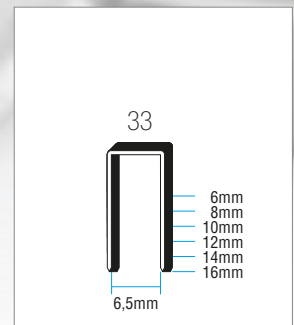

3,5m / 138" electric cable. Available plugs:



**AP** 80 M50F 606 4000 C800

Original Maestri staple use recommended  
Page 111, 112, 113, 114

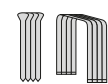

130 mm



AC110/120V  
AC220/240V  
50-60 Hz



1,40

## ELECTRIC BRAD NAILER

*Designed to work on finished products without leaving any support imprint. Special for door and*

*window frame installers, tongue and groove ceilings, etc. and for all installations in general:*

*works indifferently on soft and hard wood, from underneath.*

### Extreme PROFESSIONAL

Safety trigger and removable front plate.



High resistance body in nylon 30% reinforced fibre glass.



#### Specifications:

Noise: LpA 82,9 dBA  
LwA 94 dBA

Vibrations: 4,92 m/s<sup>2</sup>

#### Available in:



#### Compliant with directives:

- ▶ ROHS
- ▶ 2006/42/CE



CODE	ARTICLE		PACK
0215121	ME30	AP 15-19-25-30	1

MADE in ITALY





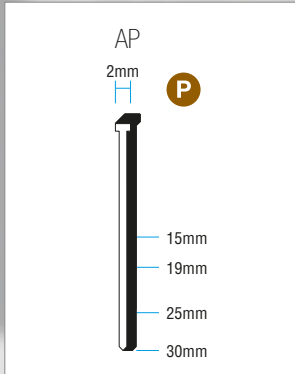

3,5m / 138" electric cable. Available plugs:



Original Maestri staple use recommended  
Page 114



130 mm



AC110/120V  
AC220/240V  
50-60 Hz



1,40

RO-MA 8016	46
RO-MA 8016BL	47
RO-MA 6414	48
RO-MA 8414	49
RO-MA 9240	50
RO-MA 9025	51
RO-MA 90 COMBI	52
RO-MA 30TG	54
RO-MA 50TG	55
RO-MA 50 CONCRETE	56
RO-MA 55 MULTIBRAD	57
RO-MA 30/64	58
RO-MA 35/64	59
RO-MA 30/08	60
RO-MA 45/08	61
PN/2	62





## PNEUMATIC TACKERS FOR LIGHT STAPLES

Powerful, lightweight, compact. Ideal for wall upholstery. Chair and sofa coverings.

Decoration works  
Heat and sound insulation installation. Trailer, camper, boat interiors.

Bottom loading.

### Rubber grip.



### Specifications:

Air consumption at 60 cycles/min: 51 ℓ/min  
Noise: LwA 96,4 dBA  
Vibrations: 1,9 m/s<sup>2</sup>

### Available in:



### Compliant with directives:

► 2006/42/CE



CODE	ARTICLE		PACK
0153143	RO-MA 8016 RED LINE	80/	1

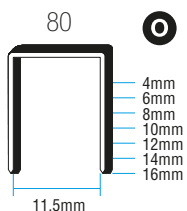

**80**

Original Maestri staple use recommended  
Page 112



130 mm

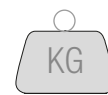

1



ATM

4/8



# RO-MA 8016 BL

CODE	ARTICLE		PACK
0231522	RO-MA 8016 BL	80/	1

Rubber grip.



Safety trigger.



Specifications:

Air consumption  
at 60 cycles/min: 31,6 l/min  
a 6,2bar (10psi)

Noise: LwA 90 dBA

Vibrations: 0,7 m/s<sup>2</sup>

Available in:



Compliant  
with directives:

► 2006/42/CE



◀ The long and thin front plate provides easy access without hindering visibility on hard to reach surfaces.

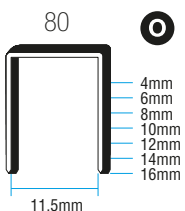

**80**

Original Maestri staple use recommended  
Page 112



130 mm

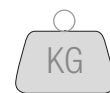

1



6/7

## PNEUMATIC TACKERS FOR LIGHT STAPLES

Powerful, lightweight, compact. Ideal for wall upholstery. Chair and sofa coverings.

Decoration works  
Heat and sound insulation installation. Trailer, camper, boat interiors.

Bottom loading.

### Rubber grip.



### Specifications:

Air consumption  
at 60 cycles/min: 85ℓ/min  
a 6,2 bar (10psi)

Noise: LpA 88 dBA

Vibrations: 2,5 m/s<sup>2</sup>

### Available in:



### Compliant with directives:

► 2006/42/CE



CODE	ARTICLE	PACK	
0153145	RO-MA 6414	64/	1

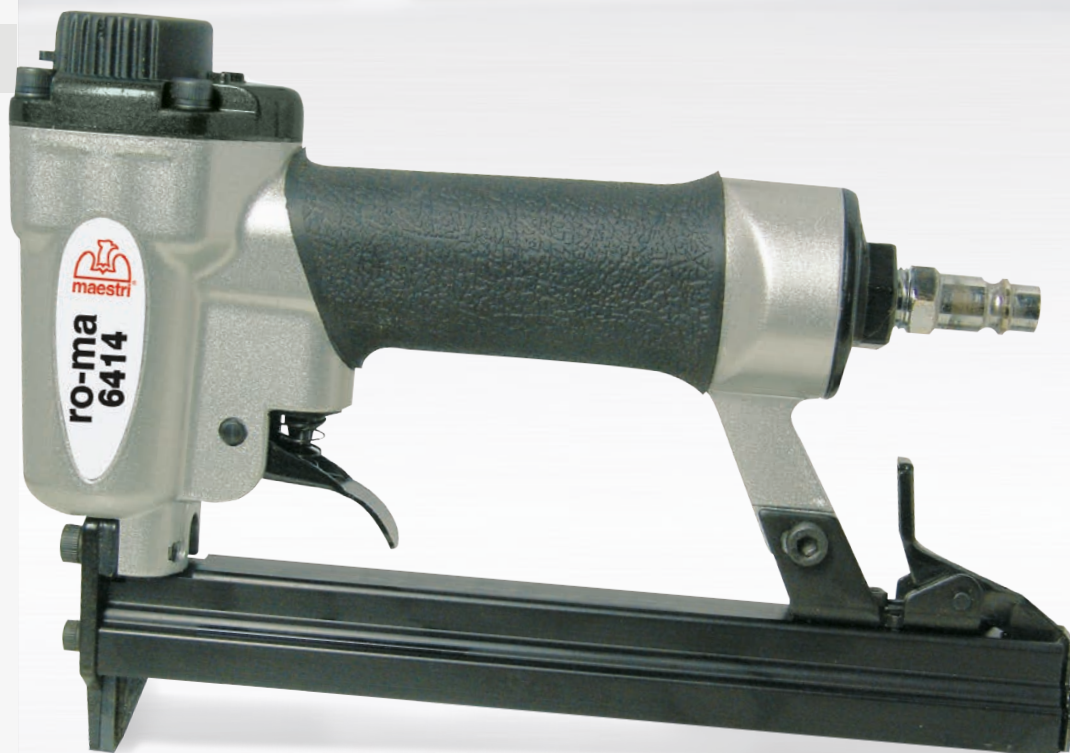

64

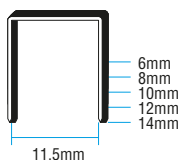

**64**

Original Maestri staple use recommended  
Page 112



150 mm



0,90



ATM

4/7

# RO-MA 8414

CODE	ARTICLE	PACK	
0153147	RO-MA 8414	84/	1

Rubber grip.



Specifications:

Air consumption  
at 60 cycles/min: 85 ℓ/min  
a 6,2 bar (10psi)  
Noise: LwA 88 dBA  
Vibrations: 2,5 m/s<sup>2</sup>

Available in:



Compliant  
with directives:

► 2006/42/CE

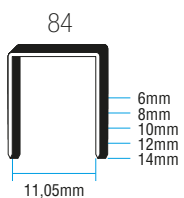
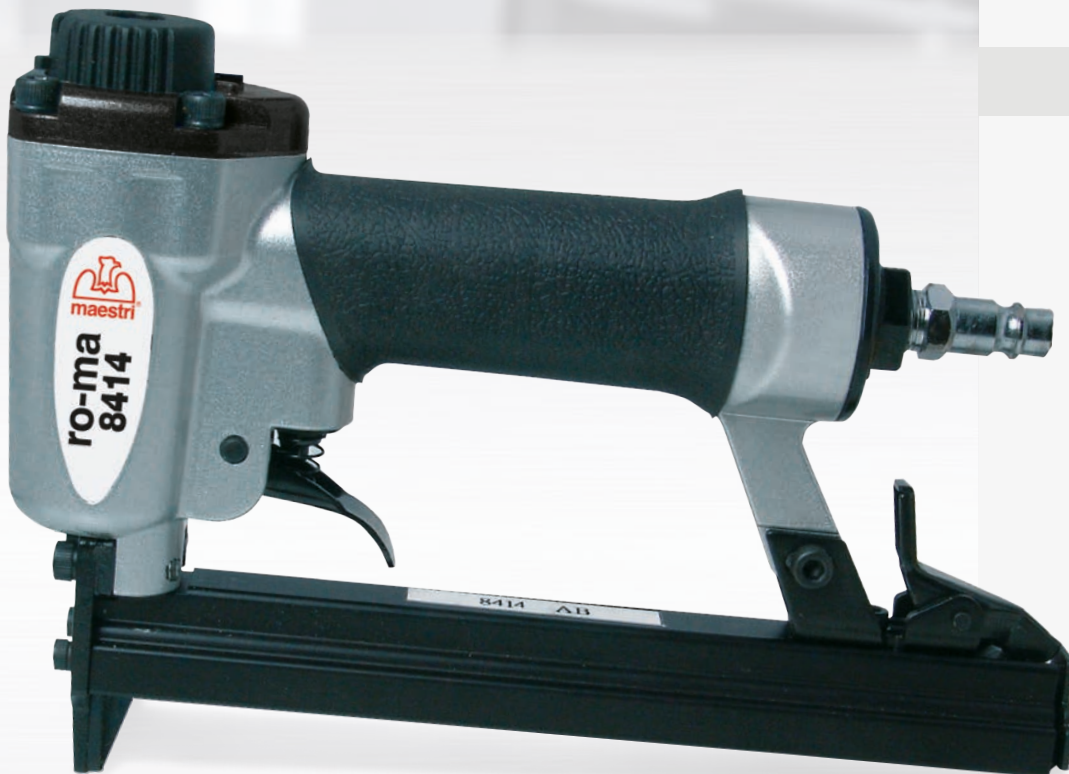

**84**

Original Maestri staple use recommended  
Page 112



130 mm

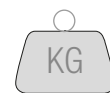

0,90



4/7



## PNEUMATIC TACKERS FOR MEDIUM STAPLES

Powerful, lightweight, compact. For craft shops, woodworking and carpentry shops. Frame

and picture construction. Bottom loading. Adjustable directional exhaust deflector.

Rubber grip.



Specifications:

Air consumption at 60 cycles/min: 56,6 l/min a 6,2 bar(10psi)

Noise: LpA 89,5 dBA

Vibrations: < 2,5 m/s<sup>2</sup>

Available in:



Compliant with directives:

► 2006/42/CE



CODE	ARTICLE	PACK	
0153115	RO-MA 9240	92/	1



92/

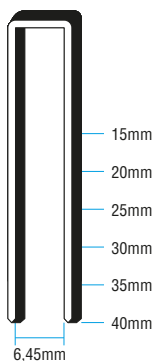

**92**

Original Maestri staple use recommended  
Page 113



150 mm



1,45



ATM

4,5/7



Powerful, lightweight,  
compact. Ideal for wall  
upholstery. Chair and sofa  
coverings.

Decoration works  
Heat and sound insulation  
installation.  
Trailer, camper, boat

interiors.  
Bottom loading.

# RO-MA 9025

CODE	ARTICLE	PACK	
0153155	RO-MA 9025	90/	1



Rubber grip.



Specifications:

Air consumption  
at 60 cycles/min: 85 ℓ/min  
a 6,2 bar

Noise: LpA 90 dBA

Vibrations: 2,7 m/s<sup>2</sup>

Available in:



Compliant  
with directives:

► 2006/42/CE

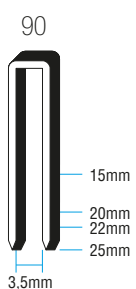

**90**

Original Maestri staple use recommended  
Page 113



140 mm

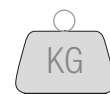

1



4/7

## PNEUMATIC TACKERS FOR MEDIUM STAPLES

Powerful, lightweight,  
compact.  
Stand set-up and store  
furnishing.

Wood profiles for door and  
window frames. Internal and  
external tongue and groove  
sliding. Side loading (brads)  
and top loading (staples).  
Adjustable directional  
exhaust deflector.

Rubber grip.



Specifications:

Air consumption  
at 60 cycles/min: 67 ℓ/min

Noise: LwA 97,1 dBA

Vibrations: 3,8 m/s<sup>2</sup>

Available in:



Compliant  
with directives:

► 2006/42/CE



CODE	ARTICLE			PACK
0153206	RO-MA 90 COMBI RED LINE	90/	AX-TG	1



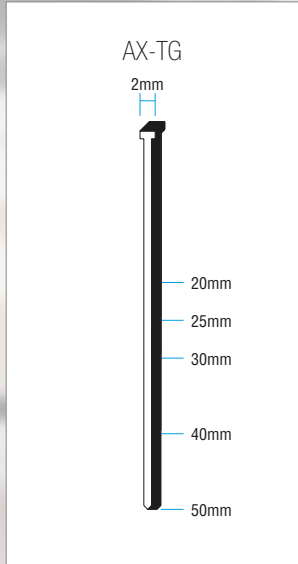
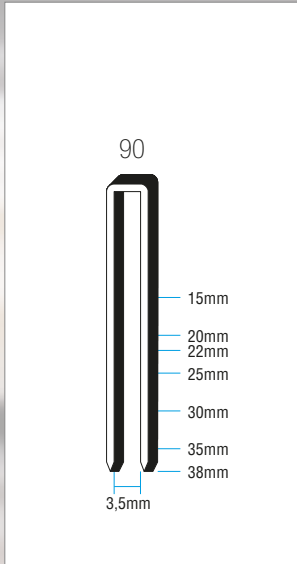

**90 AX-TG**

Original Maestri staple use recommended  
Page 113, 116

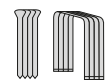

125 mm

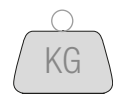

1,50



4/8

## PNEUMATIC FINISHING NAILERS FINISHING

Powerful, lightweight, compact. Ideal for internal and external tongue and groove sliding. Door

and window frames. Prefabricated coverings. Trailer, camper and boat interiors. Wall raceways.

Side loading.

Rubber grip.



Specifications:

Air consumption at 60 cycles/min: 47 ℓ/min  
Noise: LwA 102,1 dBA  
Vibrations: 3,6 m/s<sup>2</sup>

Available in:



Compliant with directives:

▶ 2006/42/CE



CODE	ARTICLE	PACK	
0157302	RO-MA 30TG RED LINE	AX-TG	1



AX-TG

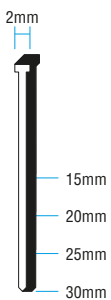

**AX-TG**

Original Maestri brads recommended  
Page 116



125 mm

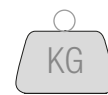

1,10



4/8



Ideal for wooden profile,  
door and window frames.  
To fasten frames on  
furniture, wall raceways,

internal and external  
tongue and groove sliding.  
Prefabricated coverings.  
Store furnishing, trailer,

camper, boat interiors.  
Side loading.

# RO-MA 50TG

CODE	ARTICLE	PACK
0157342	RO-MA 50TG RED LINE	AX-TG 1



Rubber grip.



Specifications:

Air consumption  
at 60 cycles/min: 85 ℓ/min

Noise: LwA 101 dBA

Vibrations: 3,7 m/s<sup>2</sup>

Available in:



Compliant  
with directives:

► 2006/42/CE



AX-TG

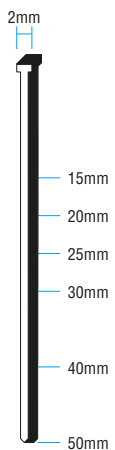

**AX-TG**

Original Maestri brads recommended  
Page 116



125 mm

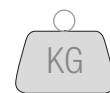

1,50



4/8

# RO-MA 50 CONCRETE

## PNEUMATIC FINISHING NAILERS FINISHING

Nailer that uses two types of brads. Hardened steel concrete to fasten plinths and profiles on cement and high resistance steel GG and trailer and camper for base board application, chair production, raceways, coffins, rustic-style furniture interiors. Side brad loading.

### Rubber grip.



### Specifications:

Air consumption at 60 cycles/min: 80 l/min  
Noise: LpA 93,76 dBA  
LwA 98,96 dBA  
Vibrations: 2,97 m/s<sup>2</sup>

### Available in:



### Compliant with directives:

► 2006/42/CE



CODE	ARTICLE			PACK
0231230	RO-MA 50 CONCRETE	Ø 1.83	GG	1

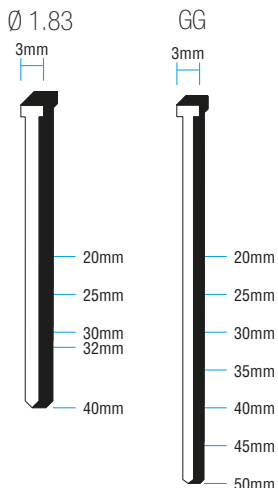

**Ø 1.83 GG**

Original Maestri brads recommended  
Page 114, 115



127 mm

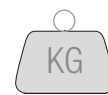

1,50



4,8/7,6  
ATM

# RO-MA 55 MULTIBRAD

Nailer that uses three types of brads. Ideal for wooden furniture and wall raceways. Store furnishing and stand set-up, trailer, camper and boat interiors.

Internal and external tongue and groove sliding. Prefabricated coverings.

CODE	ARTICLE				PACK
0231255	RO-MA 55 MULTIBRAD	AX-TG	AY-LS2	AZ-LS	1



Rubber grip.



Specifications:

Air consumption at 60 cycles/min: 80 l/min  
 Noise: LpA 91,4 dBA  
 LwA 96,9 dBA  
 Vibrations: 3,54 m/s<sup>2</sup>

Available in:



Compliant with directives:

► 2006/42/CE

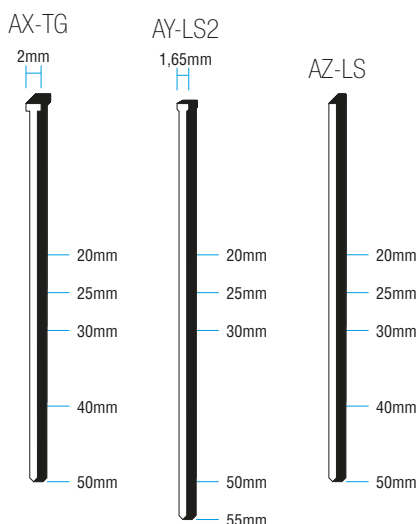

**AX-TG | AY-LS2 | AZ-LS**

Original Maestri brads recommended  
 Page 115, 116



130 mm

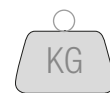

1,50



4,8/7,6



## PNEUMATIC FINISHING NAILERS FINISHING

Pneumatic nailers that use 064 micro pins and micro brads. Ideal to fasten: frames on furniture, wall

raceways. Internal and external tongue and groove sliding. Prefabricated coverings. Wood profiles for

door and window frames. Store furnishing, trailer, camper, boat interiors. Side loading.

### Rubber grip.



### Specifications:

Air consumption  
at 60 cycles/min: 56,6 ℓ/min  
a 6,2 bar (10psi)

Noise: LpA 85 dBA

Vibrations: 0,79 m/s<sup>2</sup>

### Available in:



### Compliant with directives:

► 2006/42/CE



CODE	ARTICLE			PACK
0231239	RO-MA 30/64	M064CT	M064ST	1

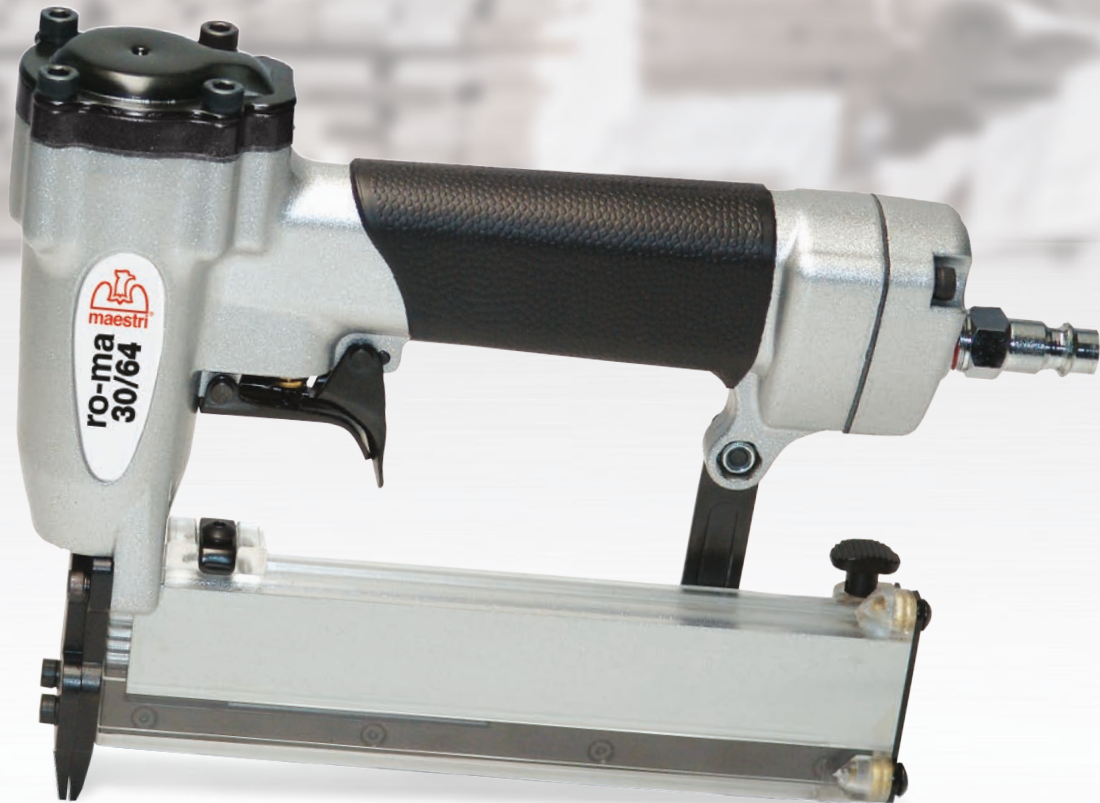

M064CT

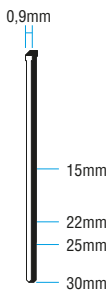

M064ST

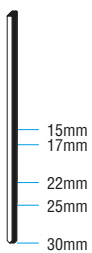

**M064CT M064ST**

Original Maestri brads recommended  
Page 116



82 mm

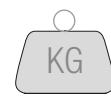

0,94



ATM

4/6



# RO-MA 35/64

CODE	ARTICLE			PACK
0231241	RO-MA 35/64	M064CT	M064ST	1

Rubber grip.



Specifications:

Air consumption  
at 60 cycles/min: 28,3 ℓ/min  
a 6,2 bar (10psi)

Noise: LpA 72 dBA  
LwA 82,9 dBA

Vibrations: 0,65 m/s<sup>2</sup>

Available in:



Compliant  
with directives:

► 2006/42/CE



M064CT

0,9mm

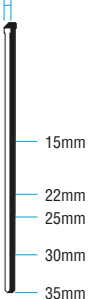

M064ST

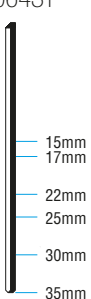

**M064CT** | **M064ST**

Original Maestri brads recommended  
Page 116



82 mm

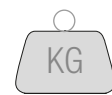

0,94



4/7

## PNEUMATIC FINISHING NAILERS FINISHING

Powerful, lightweight, compact. Ideal to fasten wooden profiles for door and window frames,

on furniture, wall raceways. Internal and external tongue and groove sliding. Prefabricated coverings.

Store furnishing, trailer, camper, boat interiors. Side loading.

### Rubber grip.



### Specifications:

Air consumption at 60 cycles/min: 43,3 ℓ/min a 6,2 bar (10psi)

Noise: LpA 88 dBA

Vibrations: 3,2 m/s<sup>2</sup>

### Available in:



### Compliant with directives:

► 2006/42/CE



CODE	ARTICLE	PACK	
0231246	RO-MA 30/08	AP08	1



AP08

1,3mm

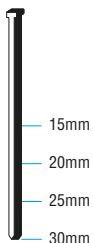

Original Maestri brads recommended  
Page 115



170 mm

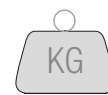

KG

1



ATM

4/7

# RO-MA 45/08

CODE	ARTICLE	PACK
0231237	RO-MA 45/08	AP08 1

Rubber grip.

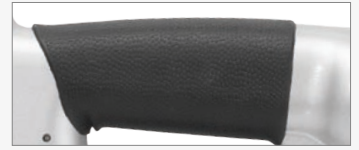

Specifications:

Air consumption  
at 60 cycles/min: 20,5 ℓ/min  
a 6,2 bar (10psi)

Noise: LpA 87,54 dBA  
LwA 93,25 dBA

Vibrations: 1,85 m/s<sup>2</sup>

Available in:



Compliant  
with directives:

► 2006/42/CE



AP08

1,3mm

H



15mm  
20mm  
25mm  
30mm  
40mm  
45mm

**AP<sup>®</sup> 08**

Original Maestri brads recommended  
Page 115



142 mm



1,10



4,1/6,9  
ATM



## PNEUMATIC STUD NAILERS

*Pneumatic tool for a fast and precise driving of decorative nails. Easy to load and operate. Casting made from*

*special aluminium alloy. New pneumatic feeding system of the nails.*

*Mainly used in furniture factories (old style furniture and armchairs), clog/footware factories, decorative work*

30% fibreglass nylon magazine.



### Specifications:

Air consumption  
at 60 cycles/min: 18 l/min  
a 6,2 bar (10psi)

Noise: LpA 80,2 dBA  
LwA 92,6 dBA

Vibrations: 2,9 m/s<sup>2</sup>

### Available in:



### Compliant with directives:

► 2006/42/CE



CODE	ARTICLE				PACK
0290108	<b>B6 PN/2</b>	6/GL	6/AN	7S/AN	1
0290120	<b>B10 PN/2</b>	10/GL	10/AN		1
0290125	<b>B11 PN/2</b>	11/GL			1

MADE in ITALY

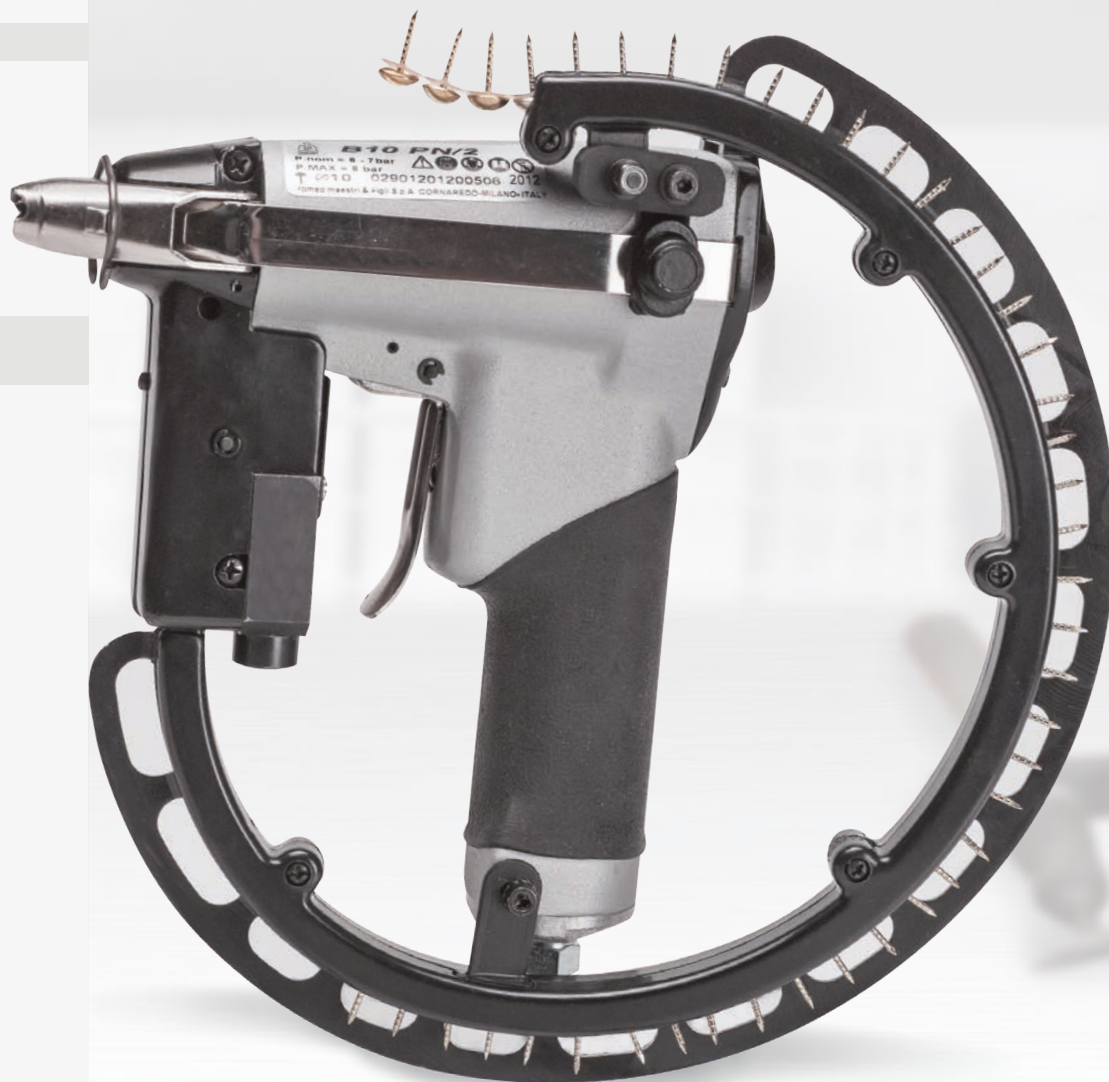

**6/GL-AN | 7S/AN | 10/GL-AN | 11/GL**



(coffers, caskets, trunks, etc)

Available in 3 models.

Mod. B6 PN/2

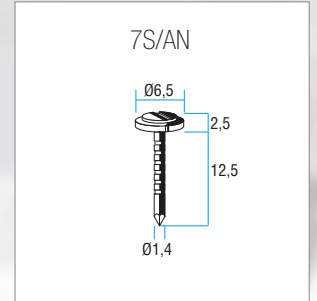
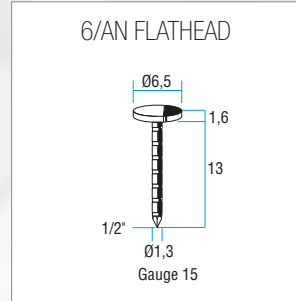
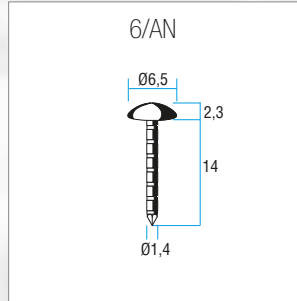
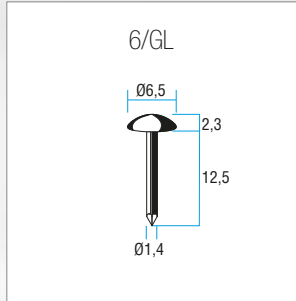

⊕ Also available with SCR imprint

Mod. B10 PN/2

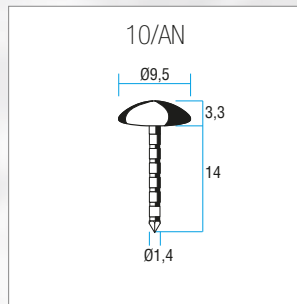
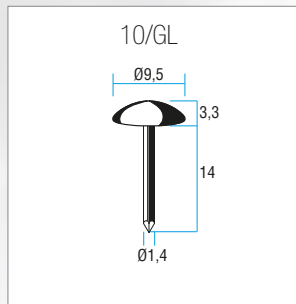

Mod. B11 PN/2

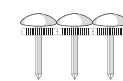
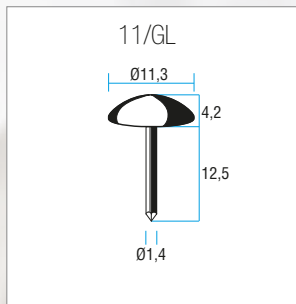

45/75

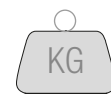

1



6/8

F12	66
FP12	67
F18	68
FP18	69
F15 FLEX	70
FP15 FLEX	71





## FRAME NAILERS MANUAL

*For all types of frame and window applications.  
Permanent fastening.*

### Adjustment power device.

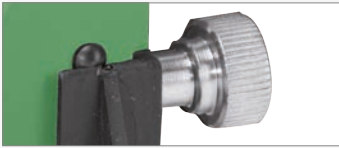

### Stabiliser.



### Specifications:

Noise: LpA 80,4 dBA  
LwA 88,8 dBA

Vibrations: 1,1 m/s<sup>2</sup>

### Available in:



CODE	ARTICLE	PACK
0123001	F12	Brads F12 <b>E</b> 4

MADE in ITALY

### BRADS F

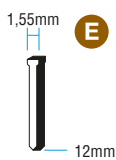

## BRADS F12

Original Maestri brads recommended  
Page 118



68 mm



KG

0,65



PNEUMATIC  
For heavy-duty use.

# FP12

CODE	ARTICLE	PACK
0123302	FP12	Brads F12 <b>E</b> 1

**MADE in ITALY**



2.000 BRADS F12 ►  
INCLUDED

Adjustment power device.

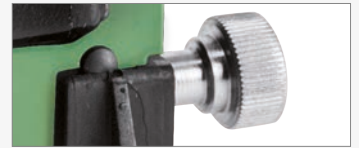

Stabiliser.



Extensible manifold  
for compressed air.



Specifications:

Air consumption  
at 60 cycles/min: 14 l/min

Available in:



Compliant with directives:

► 2006/42/CE  
**CE UK CA**

BRADS F

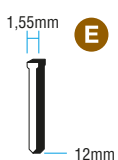

## BRADS F12

Original Maestri brads recommended  
Page 118



68 mm



0,85



4/6

## FRAME NAILERS MANUAL

For all types of frame applications.  
Permanent fastening.

### Adjustment power device.

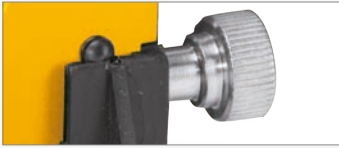

### Stabiliser.



### Specifications:

Noise: LpA 80,4 dBA  
LwA 88,8 dBA

Vibrations: 1,1 m/s<sup>2</sup>

### Available in:



CODE	ARTICLE	PACK
0123010	F18	Brads F18 <b>E</b> 4

MADE in ITALY



### BRADS F

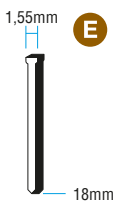

## BRADS F18

Original Maestri brads recommended  
Page 118



68 mm



KG

0,65

PNEUMATIC  
For heavy-duty use.

# FP18

CODE	ARTICLE	PACK
0123311	FP18	Brads F18 <b>E</b> 1

MADE in ITALY



2.000 BRADS F18 ►  
INCLUDED

Adjustment power device.

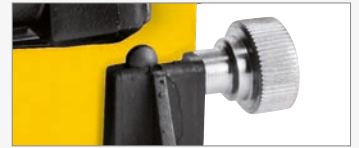

Stabiliser.



Extensible manifold  
for compressed air.



Specifications:

Air consumption  
at 60 cycles/min: 14 l/min

Available in:



Compliant with directives:

► 2006/42/CE  
**CE UK CA**

BRADS F

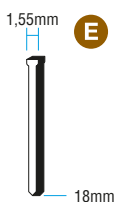

## BRADS F18

Original Maestri brads recommended  
Page 118



68 mm

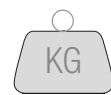

0,85



4/6



## FLEXITABS NAILERS MANUAL

*For flexible slats folded several times without damages for photos and paintings.*

Adjustment power device.

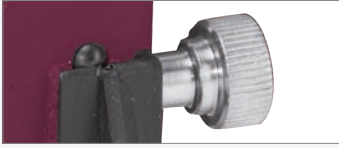

Stabiliser.



Specifications:

Noise: LpA 80,4 dBA  
LwA 88,8 dBA

Vibrations: 1,1 m/s<sup>2</sup>

Available in:



CODE	ARTICLE		PACK
0123133	F15 FLEX	Romaflex 15	4

MADE in ITALY



ROMAFLEX 15

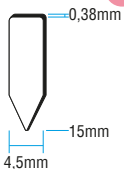

### ROMAFLEX 15

Original Maestri flexitabs recommended  
Page 118

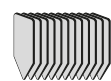

68 mm



KG

0,65



PNEUMATIC  
For heavy-duty use.

# FP15 FLEX

CODE	ARTICLE	PACK
0123313	FP15 FLEX	Romaflex 15 <b>G</b> 1

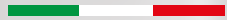
 MADE in ITALY



2.080 FLEXITABS ►  
INCLUDED

Adjustment power device.



Stabiliser.



Extensible manifold  
for compressed air.



Specifications:

Air consumption  
at 60 cycles/min: 14 l/min

Available in:



Compliant with directives:

► 2006/42/CE



ROMAFLEX 15 **G**

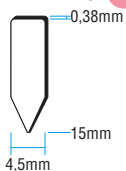

## ROMAFLEX 15

Original Maestri flexitabs recommended  
Page 118

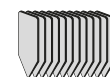

68 mm

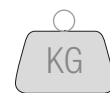

0,85



4/6

ROAMA MANUAL	74
ROAMA PNEUMATIC	75
ELPABOX BH	76
ELPABOX BA	77
RI-19/A	78
RO-MA 73	79
GF135 MECCANICA	80
GF135 PNEUMATICA	81



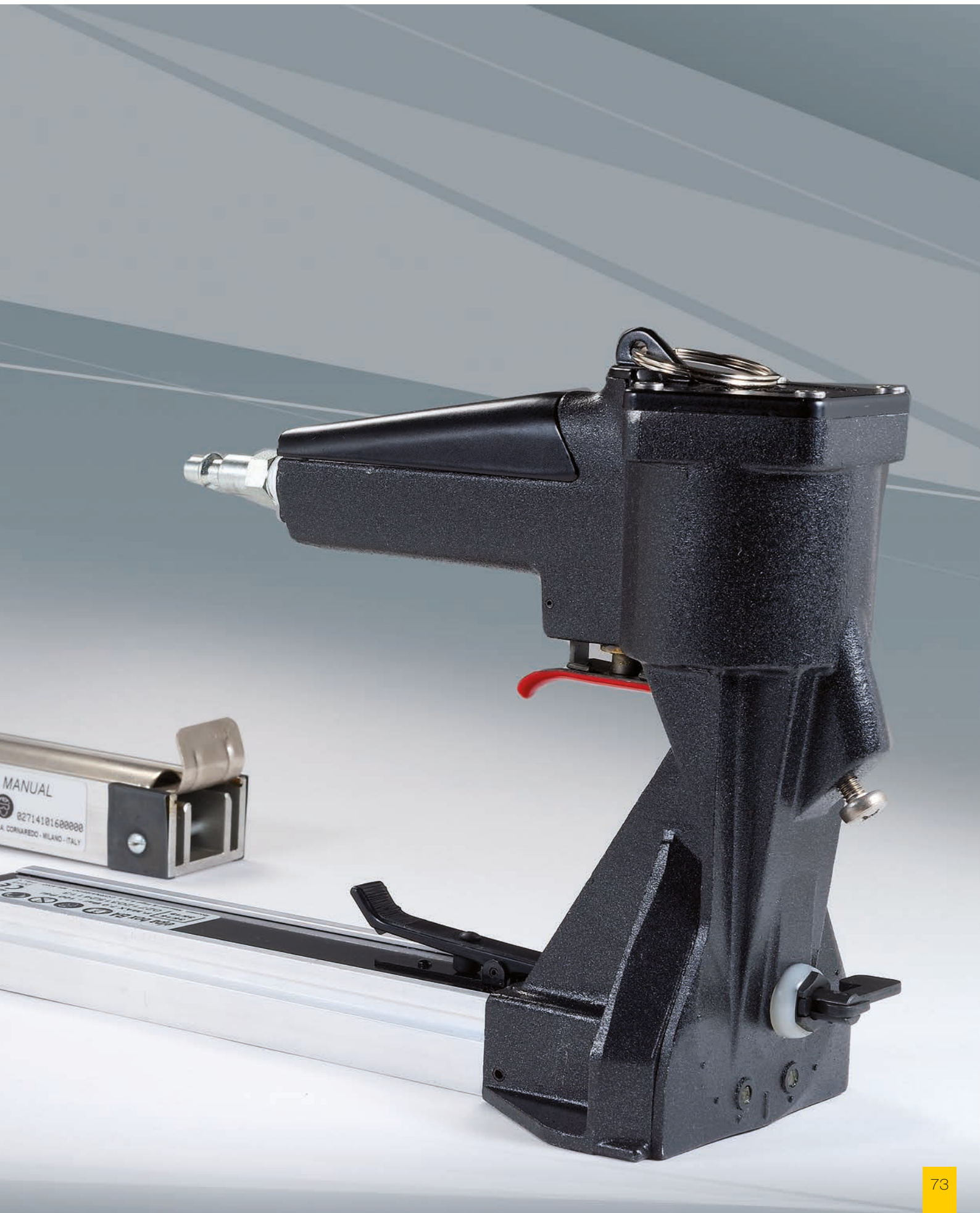



Top and bottom carton closing machines. Manual operated. Designed to guarantee high performance

with minimum effort when closing boxes. A handle is included in the top part of the body to make the tool

more manageable even for heavy-duty work.

Highly resistant aluminium alloy die-cast machine body.



Practical grip.



Available in:

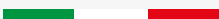

 MADE in ITALY

CODE	ARTICLE	PACK	
0271401	ROAMA 35/15	35/	1
0271405	ROAMA 35/19	35/	1
0271410	ROAMA 35/22	35/	1

Available in 3 models.

Mod. 35/15

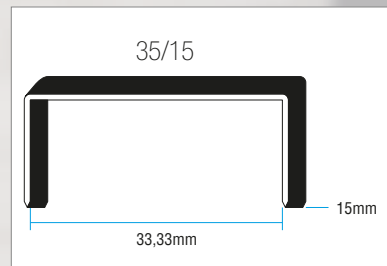

Mod. 35/19

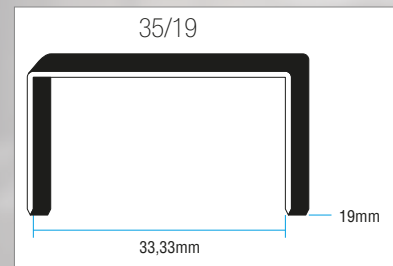

Mod. 35/22

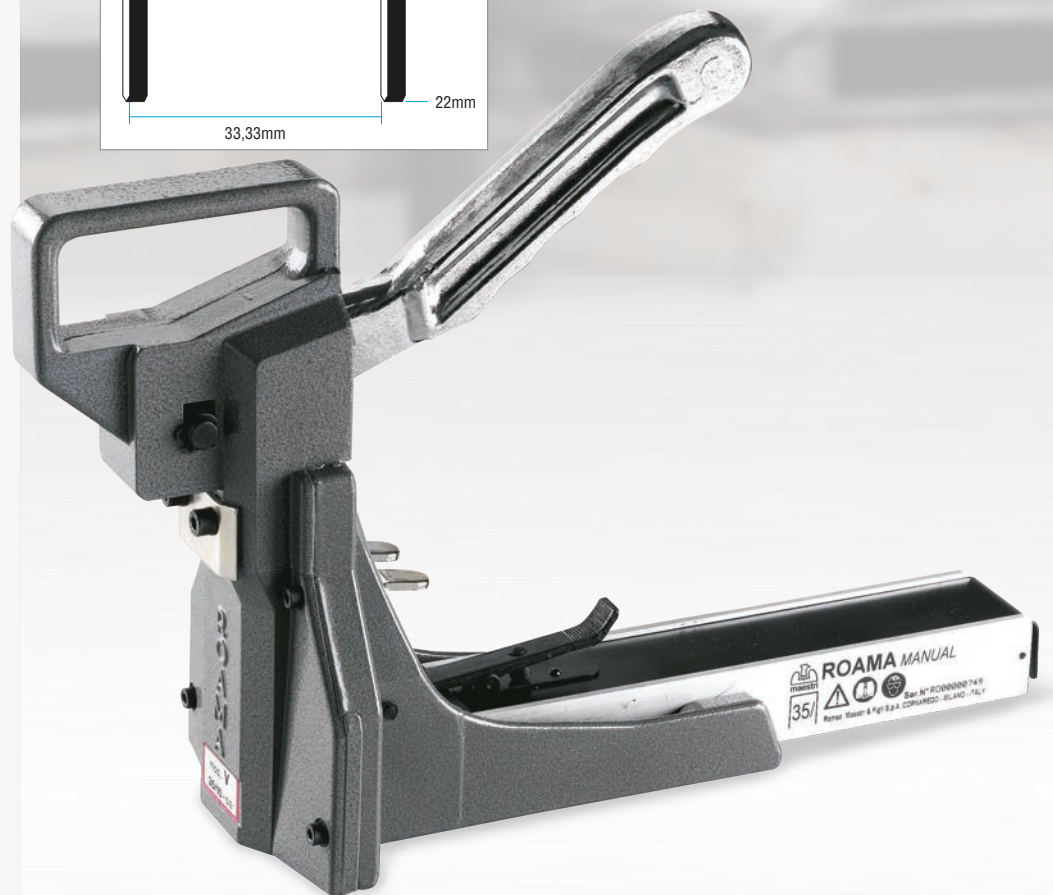
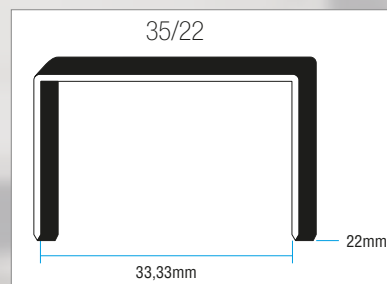

**35**

Original Maestri staple use recommended  
Page 119



210 mm



KG

2,16



# PNEUMATIC CARTON CLOSING MACHINES



## ROAMA PNEUMATIC

Top and bottom carton closing machines. Pneumatic type. Designed to guarantee high performance with closing boxes.

CODE	ARTICLE	35/	PACK
0271501	ROAMA 35/15	35/	1
0271505	ROAMA 35/19	35/	1
0271510	ROAMA 35/22	35/	1

Available in 3 models.

Mod. 35/15

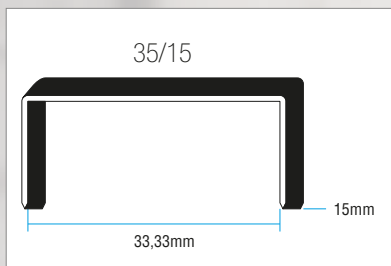

Mod. 35/19

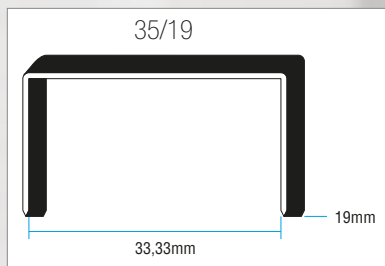

Mod. 35/22

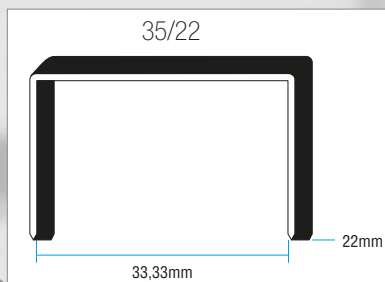

Highly resistant aluminium alloy die-cast machine body.



Practical hook.



Specifications:

Air consumption at 60 cycles/min: 84 ℓ/min  
 Noise: LpA 80,9 dBA  
 LwA 94 dBA  
 Vibrations: 2,81 m/s<sup>2</sup>

Available in:



Compliant with directives:

► 2006/42/CE



MADE in ITALY



**35**

Original Maestri staple use recommended  
 Page 119



210 mm



2,60



6

## ELPABOX BH

Light and handy manual carton machines. Ideal to close lids, box bottoms and corrugated cardboard. Body made of

special aluminium alloy. The front grip guarantees higher stability and seaming speed. Equipped with seam depth and

staple shape adjustment. Two heights of metal staples in the same machine.

Depth regulator.



Practical grip.



Available in:



CODE	ARTICLE	PACK	
0271103	ELPABOX BH-35	35/	1

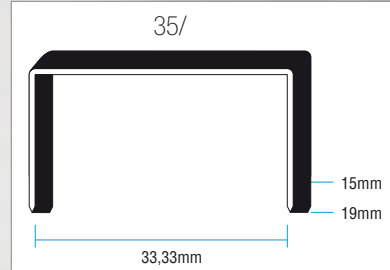

MADE in ITALY



35/15

35/19

**35**

Original Maestri staple use recommended  
Page 119



200 mm



KG

1,30

# PNEUMATIC CARTON CLOSING MACHINES



## ELPABOX BA

Compact and light  
pneumatic carton machines.  
Designed to guarantee  
high performance when

closing boxes.  
Equipped with an ample  
support surface that avoids  
annoying movements

when seaming.  
Closure depth and staple  
shape adjustment.

CODE	ARTICLE	PACK	
0271203	ELPABOX BA-35	35/	1

 MADE in ITALY

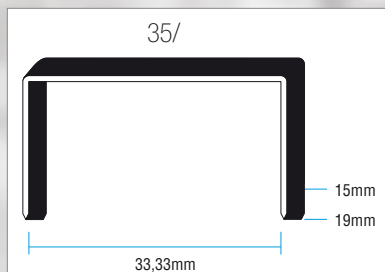

### Depth regulator.



Highly resistant aluminium  
alloy die-cast machine body.



### Specifications:

Air consumption  
at 30 cycles/min: 33 l/min  
Noise: LpA 78,5 dBA  
LwA 91,5 dBA  
Vibrations: 2,41 m/s<sup>2</sup>

### Available in:



### Compliant with directives:

► 2006/42/CE



35/15

35/19

**35**

Original Maestri staple use recommended  
Page 119



200 mm



1,60



5/7



# RI-19/A

## PNEUMATIC STAPLER FOR STAPLES ROLLS

Compact and lightweight seamer equipped with an ample support surface that avoids

annoying movements when seaming. Suited to close corrugated cardboard

boxes in series. Closure depth and staple shape adjustment.

Highly resistant aluminium alloy die-cast machine body.

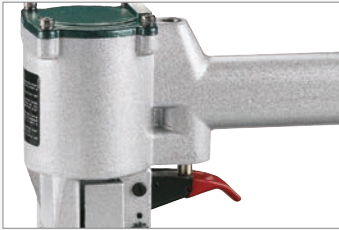

### Specifications:

Air consumption at 60 cycles/min: 67 l/min  
 Noise: LpA 89 dBA, LwA 95 dBA  
 Vibrations: 3,8 m/s<sup>2</sup>

### Compliant with directives:

► 2006/42/CE



CODE	ARTICLE		PACK
0271230	RI-19/A	M15/A - M19/A	1

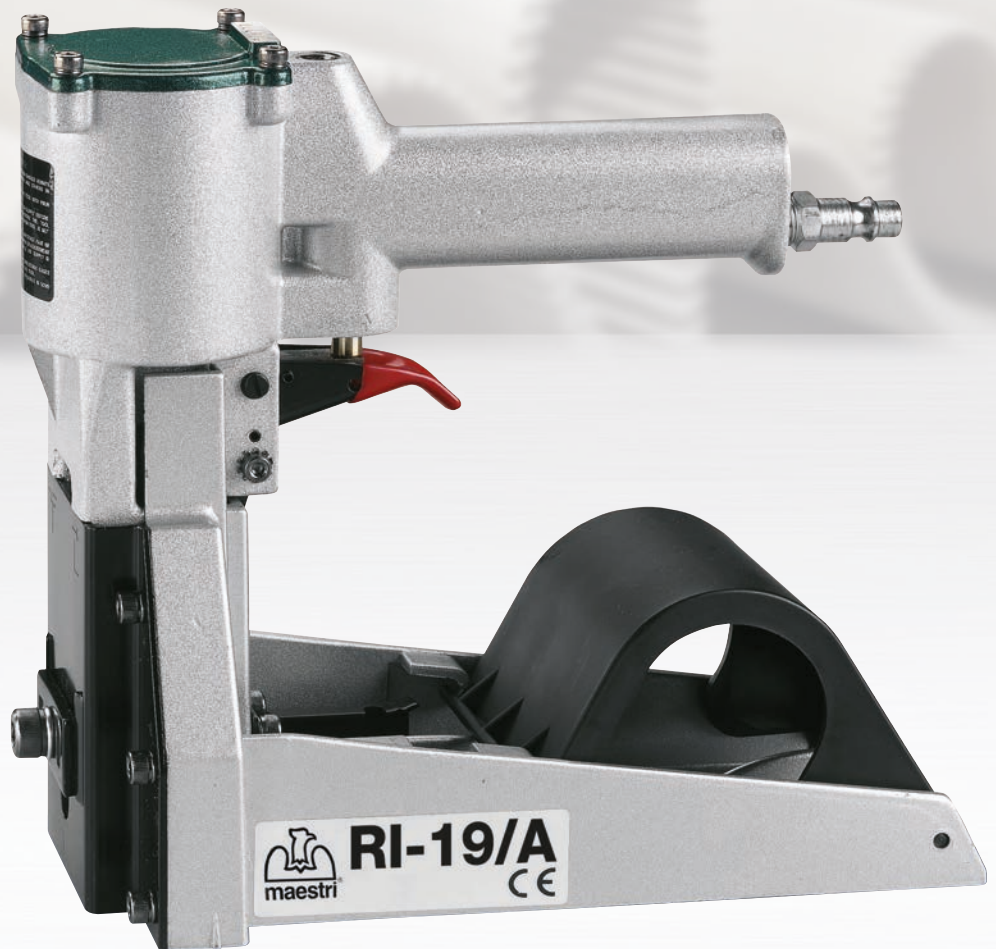

M15/A - M19/A

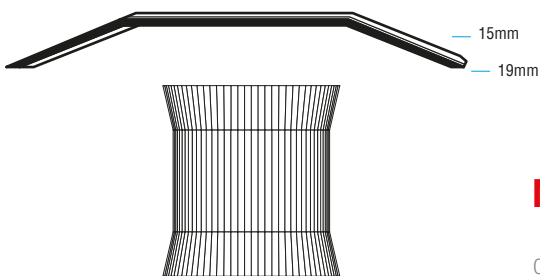

### M15/A M19/A

Original Maestri staple use recommended  
 Page 120



1000



2,40



5/7



# STAPLING PLIER FOR MEDIUM THICKNESS



Stapler with accessories especially suited for medium-large thickness stapling (bags, cardboard,

padded envelopes, corrugated cardboard boxes, etc.). Highly robust, with hand safety block.

Traditional rear loading. Stapling capacity: 6 mm approx.

## RO-MA 73

CODE	ARTICLE	73/	PACK
0040120	RO-MA 73	73/	5
0099205	RO-MA 73 KIT (73/8 - 73/10 - 73/12) - 15.000	73/	1

Safety lock.



Sword base to staple cardboard box flaps.



Rounded base to staple cellophane and polyethylene bags.



Available in:

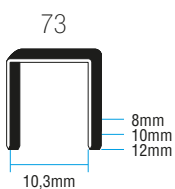

**73**

Original Maestri staple use recommended  
Page 119



93 mm

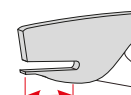

68 mm

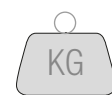

0,46



# MANUAL CARTON CLOSING MACHINES

## GF135 MECCANICA

Carton closing machine to close corrugated cardboard box bottoms.

Mechanical pedal.

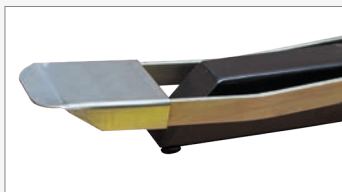

Safety device.



CODE	ARTICLE	PACK	
0271705	GF135 MECCANICA	35/	1

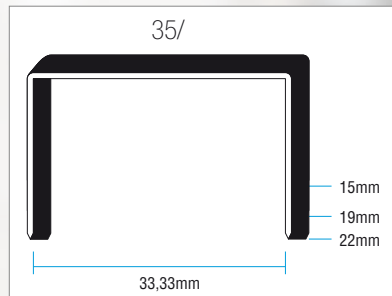

MADE in ITALY



35/15

35/19

35/22

**35**

Original Maestri staple use recommended  
Page 119



380 mm

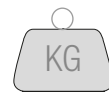

KG

35

# PNEUMATIC CARTON CLOSING MACHINES



For heavy-duty use.

## GF135 PNEUMATICA

CODE	ARTICLE	PACK
0271725	GF135 PNEUMATICA	35/ 1

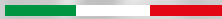
 MADE in ITALY

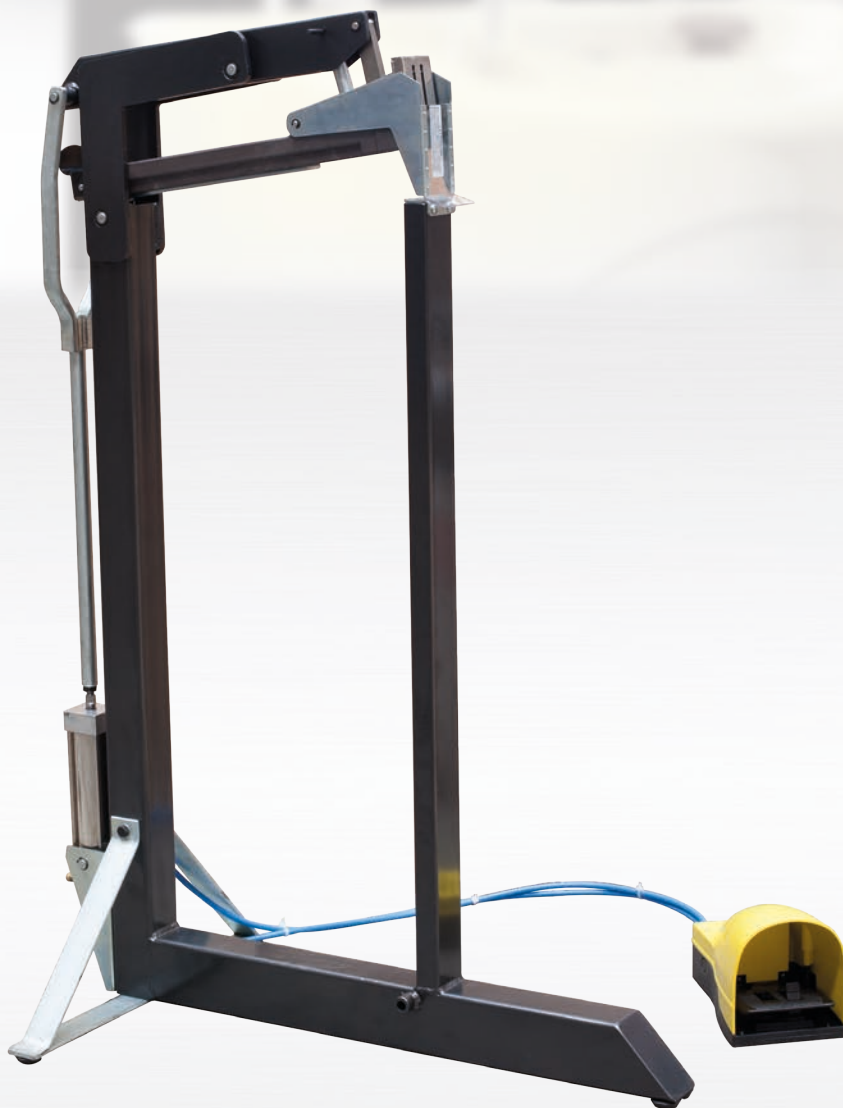
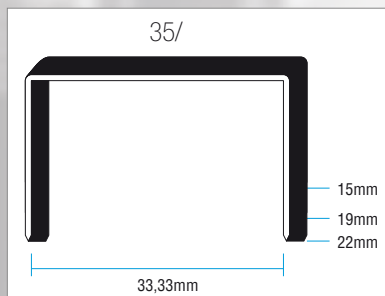

Pneumatic powered pedal.



Safety device.



Specifications:

Air consumption  
at 60 cycles/min: 170 ℓ/min  
Noise: LpA <80 dBA  
Vibrations: <2,5 m/s<sup>2</sup>

Compliant with directives:

► 2006/42/CE



**35**

Original Maestri staple use recommended  
Page 119



380 mm

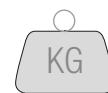

35



5/7

MULTENS	84
B051	86
320 - M13-32	87
BAND-IT C001	88
FA/PLAST - MPL	90
TB 1216	92
TB 1620	93
M4000 - PR/P	94
EASY PACK	95





STRAPPING  
SEALING



## MANUAL STRAPPING TOOLS FOR METAL STRAPPING

Used to seal packages of different types, dimensions and materials (plastic, wood etc) with metal strap and

relative steel strap. It makes the strapping and cutting operation at the same time. Robust, handy, easy to use tool.

Adjustable punch for sizes 13-16mm/18-20mm.

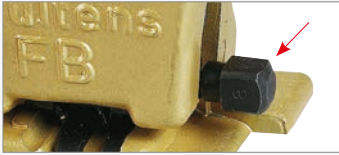

Available in:



CODE	ARTICLE	PACK
0173310	<b>MULTENS FB4</b>	1
0173312	<b>MULTENS FB320</b>	1

 MADE in ITALY



Mod. FB4 adjustable punch

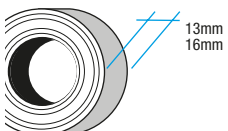

Page 121

Mod. FB320 adjustable punch

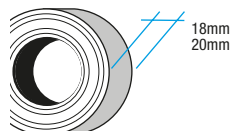

Page 121



3,90

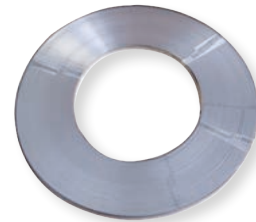

**NEUTRAL STEEL SEALS AND  
PRINTED (for 50.000 pcs.)**

**METALLIC STRAP WITH ROUNDED EDGES**  
ø internal 300 mm - ø external 550 mm

thickness 0,3 mm

thickness 0,5 - 0,6 - 1 mm

**313**

**316**

**320**

**13**

**16**

**18**

**20**

**MULTENS  
FB4**

•

•

•

•

**MULTENS  
FB320**

•

•

•

## B051

*Universal steel strapper.  
Ideal for vertical and  
horizontal straps.*

Interlocking system and  
strap cutter.



CODE	ARTICLE	PACK
0292120	B051	1

**WITHOUT  
SEAL**



Mod. B051

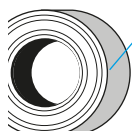

13mm  
16mm  
18mm  
19mm  
20mm  
thickness  
0,60mm

Page 121



4,25



# DISPENSER FOR METAL STRAPPING



Steel strap dispenser.  
Spool Ø external from 500 to  
600 mm.

## 320 - M13-32

CODE	ARTICLE	PACK
0191121	<b>320</b>	1
0191133	<b>M13-32</b>	1

 MADE in ITALY

Equipped with wheels for  
easy movement.

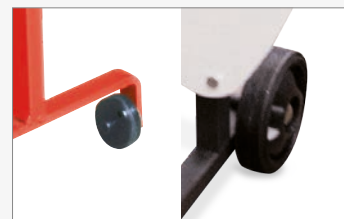

Mod. 320

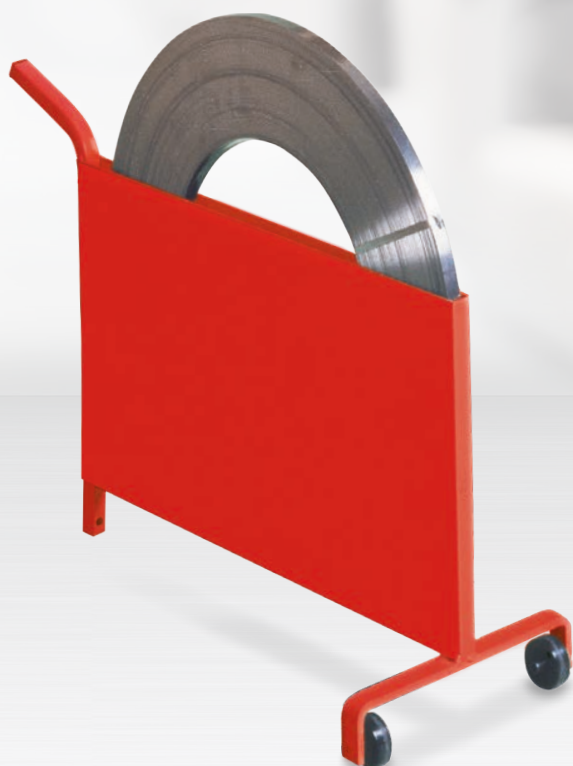

Mod. M13-32



Mod. 320

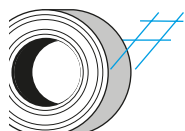

10mm  
20mm

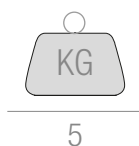

Page 121

Mod. M13-32

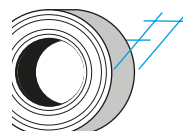

13mm  
32mm

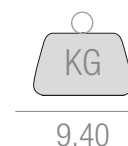

Page 121

*Stainless steel strap  
tensioning steel tool.*

## BAND-IT C001

Sturdy machine body.



Available in:



CODE	ARTICLE	PACK
0173601	C001 BAND-IT	1





Band-It tape

CODE	ARTICLE	MATERIAL	MT	PACK	Break Load Kg/mm <sup>2</sup>
1180001	<b>C202</b> 6,4x0,51 mm - 1/4"	STAINLESS STEEL	30	1	225
1180003	<b>C203</b> 9,5x0,64 mm - 3/8"	STAINLESS STEEL	30	1	400
1180005	<b>C204</b> 12,7x0,76 mm - 1/2"	STAINLESS STEEL	30	1	680
1180007	<b>C205</b> 15,9x0,76 mm - 5/8"	STAINLESS STEEL	30	1	890
1180009	<b>C206</b> 19,1x0,76 mm - 3/4"	STAINLESS STEEL	30	1	1090



Band-It staples

CODE	ARTICLE	MATERIAL	PCS	PACK
1181001	<b>C252</b> 6,4 mm - 1/4"	STAINLESS STEEL	100	1
1181003	<b>C253</b> 9,5 mm - 3/8"	STAINLESS STEEL	100	1
1181005	<b>C254</b> 12,7 mm - 1/2"	STAINLESS STEEL	100	1
1181007	<b>C255</b> 15,9 mm - 5/8"	STAINLESS STEEL	100	1
1181009	<b>C256</b> 19,1 mm - 3/4"	STAINLESS STEEL	100	1

# FA/PLAST MPL

## MANUAL STRAPPING TOOLS FOR PLASTIC STRAPPING

Manual strapping tools  
with direct traction  
for polypropylene straps.  
Embossed sheet metal

drive levers equipped with  
convenient non-slip knobs,  
red die-cast aluminium  
support base, robust and

ample. Suited to close  
corrugated cardboard  
boxes and packages of  
various types and sizes,

Version with bracket ideal for  
vertical strapping.

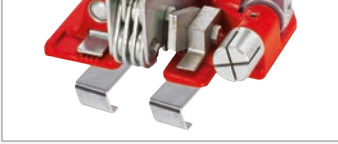

Available in:

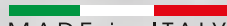

CODE	ARTICLE	PACK
0173111	FA/PLAST 13-16	1
0173113	MPL 13	1
0173114	MPL 16	1
0173106	MPL 13 BRACKET	1
0173109	MPL 16 BRACKET	1

 MADE in ITALY



Mod. FA/PLAST 13-16

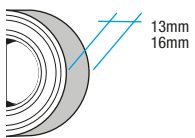

Page 123

Mod. MPL13

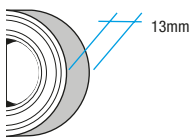

Page 123

Mod. MPL16

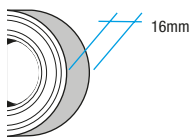

Page 123



2,60



they guarantee an open  
hermetic seal with minimum  
force on the levers.

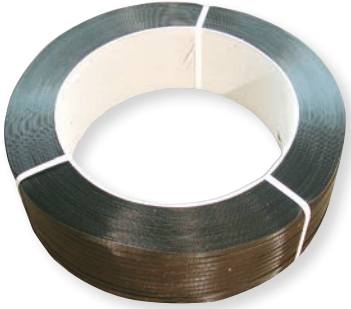

				
	<b>ENGRAVED STEEL SEALS AND PRINTED</b> (for 50.000 pcs.)		<b>HIGH RESISTANCE POLYPROPYLENE STRAP</b>	
	thickness 0,4 mm (LA) - 0,5 mm (PA)		spool ø internal 60 mm - ø internal 400 mm thickness 0,5 - 0,6 - 0,8 mm	
	<b>13</b>	<b>16</b>	<b>12</b>	<b>15</b>
<b>FA/PLAST 13-16</b>	•	•	•	•
<b>MPL 13</b>	•		•	
<b>MPL 16</b>		•		•

## BATTERY POWERED STRAPPING TOOLS FOR PLASTIC STRAPPING

One of the lightest battery powered strapping tools of its kind, it uses 12-15 mm polypropylene (PP) and

polyester (PET) straps without using seals. Single-handed use.

Maximum tension 250KG (2500N) standard tensioning.

Practical grip.



Battery release button.



Tension button **A**  
Welding lever **B**



Available in:



Compliant with directives:

- ▶ ROHS
- ▶ Safety regulation UN 38.3 standard lithium battery
- ▶ 2006/42/CE



CODE	ARTICLE	PACK
0292146	TB 1216	1

### WITHOUT SEAL



Mod. TB 1216

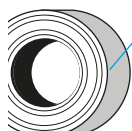

12mm  
16mm

thickness  
0,65-1,00mm

Page 123



LITHIUM BATTERY  
18V 400mAh



3,50  
BATTERY  
INCLUDED

# TB 1620

One of the lightest battery powered strapping tools of its kind, it uses 15-19 mm polypropylene (PP) and

polyester (PET) straps without using seals. Single-handed use.

Maximum tension 400KG (4000N) high tensioning.

CODE	ARTICLE	PACK
0292147	TB 1620	1

**WITHOUT SEAL**



BATTERY CHARGER AND LITHIUM BATTERY INCLUDED

Practical grip.



Battery release button.



Tension button **A**  
Welding lever **B**



Available in:



Compliant with directives:

- ▶ ROHS
- ▶ Safety regulation UN 38.3 standard lithium battery
- ▶ 2006/42/CE

**CE UK CA**

Mod. TB 1620

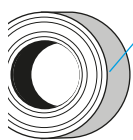

15mm  
19mm

thickness  
0,70-1,27mm

Page 123



LITHIUM BATTERY  
18V 400mAh



3,50  
BATTERY  
INCLUDED



# DISPENSER FOR PLASTIC STRAPPING

Steel strap dispenser for polypropylene strap spools. Front loading.

**M4000:** big spools  
Ø internal 395/400 mm

**PR/P:** small spools  
Ø internal 60/62 mm

## M4000 - PR/P

**M4000**  
Piratical tool compartment.



**PR/P**  
Supporting hook.



CODE	ARTICLE	PACK
0191103	<b>M4000</b>	1
0191101	<b>PR/P</b>	1

MADE in ITALY



Mod. M4000



Mod. PR/P

Mod. M4000

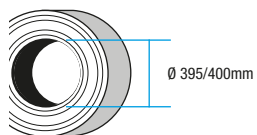

Page 123

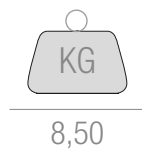

Mod. PR/P

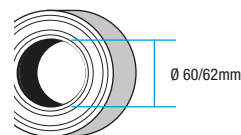

Page 123

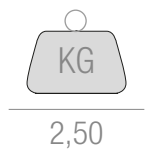



# PACKAGING KIT FOR STRAPPING



*Easy to use, ideal for boxes, crates, pipes, documents and folders, books, etc.*

## EASY PACK

CODE	ARTICLE	PACK
0199994	KIT EASY PACK	1

600 mt PP strap.



200 plastic seals.



1 cutter.



Available in:

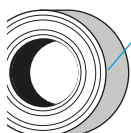
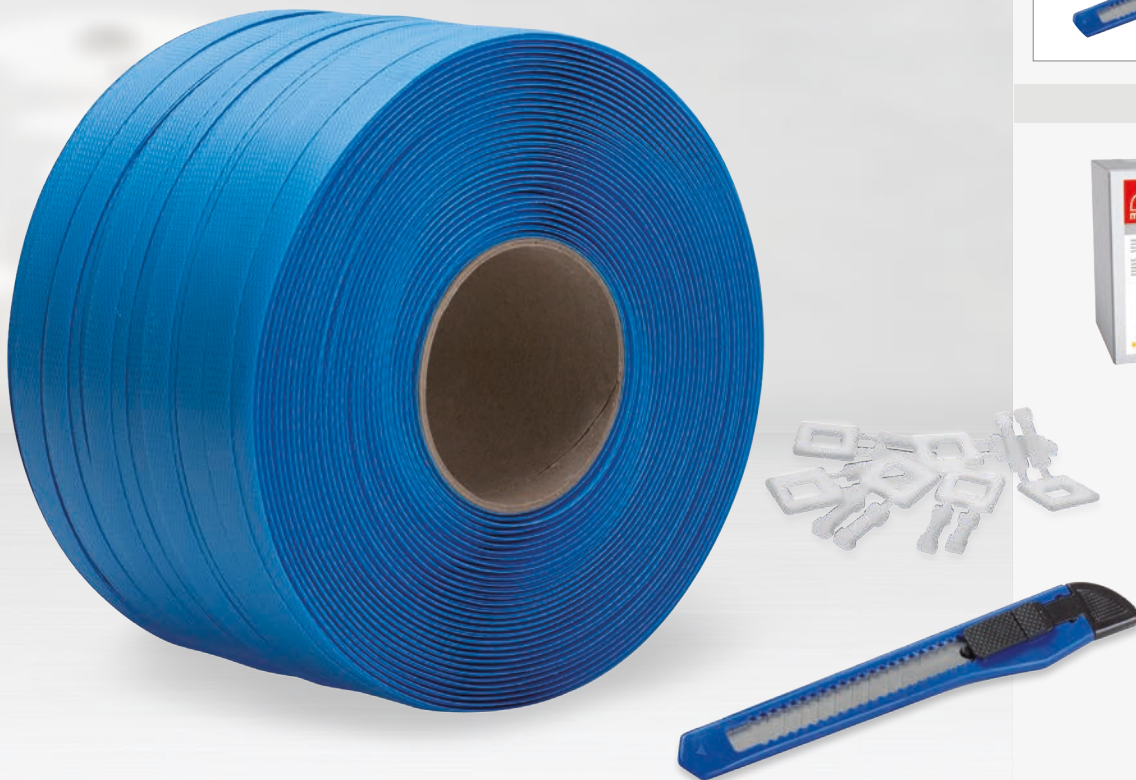

12mm

thickness  
0,45mm

Page 123



2,80

MINIGRIP 7H	98
GRIP 11H	99
GRIP 15HL	100
GRIP 18HP	101
GRIP 20XP	102
M 195	103
M 220	104
M 3350	105
M 812	106
M812 MG	107
M12/M7/H12/L12	108





# MINIGRIP 7H

## GLUE GUNS

New line electric glue gun for small repairs, ceramics, for hot melt adhesives, glass and wood. lightweight and manageable For standard for "DIY", especially suited Ø 7mm glue.

### HOBBY

Anti-drop nozzle with silicone protection.



Power 10W

Supporting stand.



Available in:



Compliant with directives:

- ▶ ROHS
- ▶ 2006/42/CE



CODE	ARTICLE	PACK
0195122	MINIGRIP 7H	12

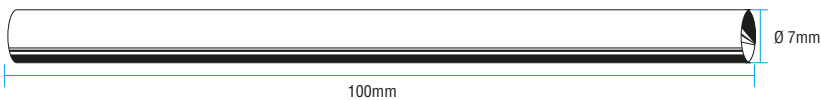

Available glue colour:  
● Transparent

**M7**

Original Maestri glue recommended  
Page 109



AC220/240V  
50-60 Hz



0,17



New line electric glue gun for hot melt adhesives, lightweight and manageable for "DIY", suited for wood,

plastic, cardboard, rubber and leather assembly and repairs, tile and porcelain installation and repairs.

For standard Ø 12mm glue.

# GRIP 11H

## HOBBY

Anti-drop nozzle with silicone protection.

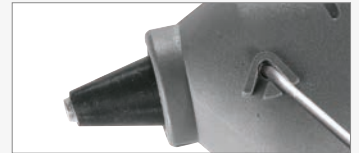

Power 30W

Maximum glue output/hour: 360g/h.

Supporting stand.



Available in:



Compliant with directives:

- ▶ ROHS
- ▶ 2006/42/CE

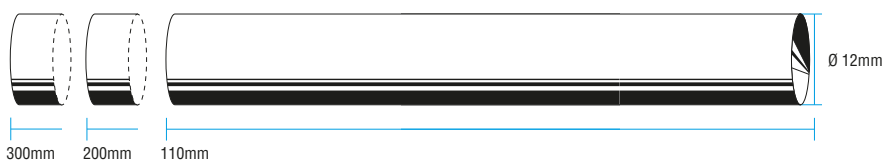

Available glue colour:

- Transparent
- White
- Honey
- Red
- Black
- Grey

**M12 | H12**

Original Maestri glue recommended  
Page 109

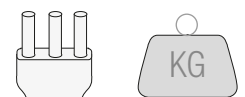

AC220/240V 50-60 Hz 0,25

## GRIP 15HL

New line electric glue guns for hot melt adhesives, lightweight and manageable for "DIY", suited for wood, plastic, cardboard, rubber and leather assembly and repairs, tile and porcelain installation and repairs. For standard Ø 12mm glue.

### HOBBY

Insulated anti-drop nozzle, removable and interchangeable.



Power 40W

Maximum glue output/hour: 530g/h.

Supporting stand.

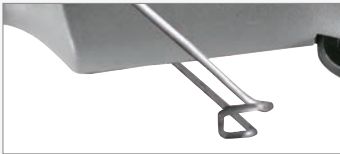

Available in:



Compliant with directives:

- ▶ ROHS
- ▶ 2006/42/CE



CODE	ARTICLE	PACK
0195136	GRIP 15HL	10

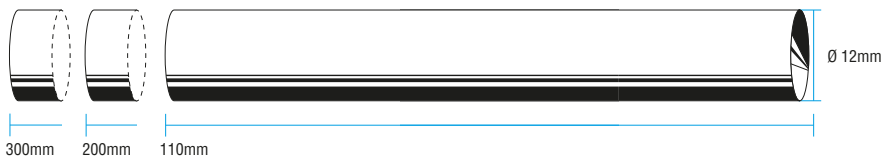

Available glue colour:

- Transparent
- White
- Honey
- Red
- Black
- Grey

**M12 | H12**

Original Maestri glue recommended  
Page 109



AC220/240V  
50-60 Hz



KG

0,30

# GRIP 18HP

## HOBBY

Insulated anti-drop nozzle, removable and interchangeable.



Power 60W

Maximum glue output/hour: 550g/h.

Supporting stand.



Available in:



Compliant with directives:

- ▶ ROHS
- ▶ 2006/42/CE



CODE	ARTICLE	PACK
0195137	GRIP 18HP	6

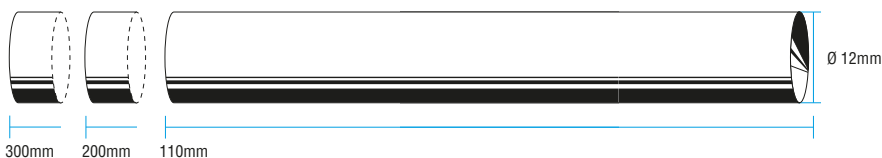

Available glue colour:

- Transparent
- White
- Honey
- Red
- Black
- Grey

**M12 | H12**

Original Maestri glue recommended  
Page 109

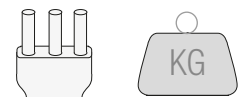

AC220/240V  
50-60 Hz

0,31

## GLUE GUNS

New line electric glue gun for hot melt adhesives, lightweight and manageable for "DIY", especially suited for wood, plastic,

cardboard, rubber and leather assembly and repairs, tile and porcelain installation and repairs. Equipped with safety

thermostat that turns the glue gun off if left idle for 15 minutes and power LED. For standard Ø 12 mm glue.

### HOBBY

Insulated anti-drop nozzle, removable and interchangeable.



Power 80W

Maximum glue output/hour: 1 kg/h.

Supporting stand.

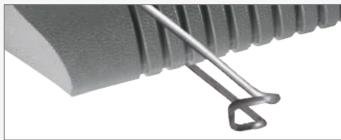

Available in:



included:

- ▶ 1 spreaded tip nozzle
- ▶ 1 extender tip nozzle
- ▶ 6 glue sticks  
Ø 12/100 transparent
- ▶ 6 glue sticks  
Ø 12/100 honey

Insulation class:

- ▶ CLASS 1

Compliant with directives:

- ▶ ROHS
- ▶ 2006/42/CE



CODE	ARTICLE	PACK
0195138	GRIP 20XP	5

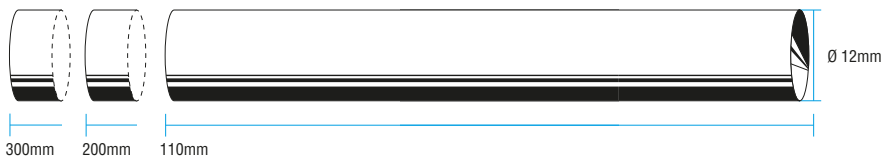

Available glue colour:

- Transparent
- White
- Honey
- Red
- Black
- Grey

**M12 H12**

Original Maestri glue recommended  
Page 109



AC220/240V  
50-60 Hz



KG

0,50



New line electric glue gun for hot melt adhesives. Lightweight and manageable for professional

use. Suited for wood, plastic, cardboard, paper, fabric, rubber and leather assembly and repairs, tile

and porcelain installation and repairs. For standard Ø 12 mm glue.

# M 195

## PROFESSIONAL

Anti-drop nozzle with silicone protection.



Power 120W

Maximum glue output/hour: 1,1kg/h.

Supporting stand.



On/off switch.



Available in:



included:

- ▶ 1 spare nozzle

Compliant with directives:

- ▶ ROHS
- ▶ 2006/42/CE

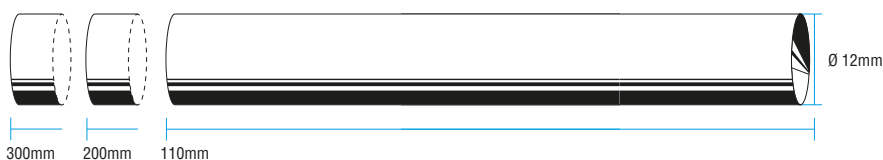

Available glue colour:

- Transparent
- White
- Honey
- Red
- Black
- Grey

**M12 | H12**

Original Maestri glue recommended  
Page 109

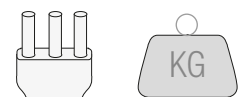

AC220/240V 50-60 Hz 0,47

# M 220

## GLUE GUNS

New line electric glue guns for hot melt adhesives. Lightweight and manageable for professional

use. Suited for wood, plastic, cardboard, paper, fabric, rubber and leather assembly and repairs, tile

and porcelain installation and repairs. For standard Ø 12 mm glue.

### PROFESSIONAL

Insulated anti-drop nozzle, removable and interchangeable.



Power 220W

Maximum glue output/hour: 1,2 kg/h.

Supporting stand.



Temperature control to manage operating temperature.



Available in:



included:

- ▶ 1 spare nozzle
- ▶ 1 screwdriver

Insulation class:

- ▶ CLASS 1

Compliant with directives:

- ▶ ROHS
- ▶ 2006/42/CE

CODE	ARTICLE	PACK
0195221	M 220 RED LINE	1

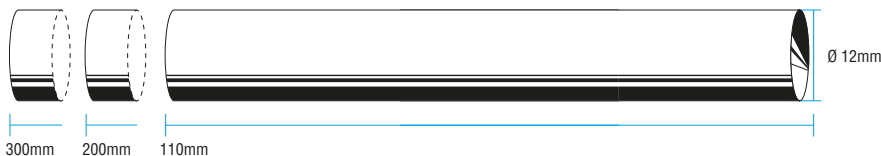

Available glue colour:

- Transparent
- White
- Honey
- Red
- Black
- Grey

**M12 | H12**

Original Maestri glue recommended  
Page 109



AC220/240V  
50-60 Hz



0,60  
KG

# M 3350

## Extreme PROFESSIONAL

Insulated anti-drop nozzle, removable and interchangeable.



Power 300W

Maximum glue output/hour: 1,5 kg/h.

Temperature control to manage operating temperature.



Supporting stand.



Available in:



included:

- ▶ 1 spare nozzle

Insulation class:

- ▶ CLASS 1

Compliant with directives:

- ▶ ROHS
- ▶ 2006/42/CE

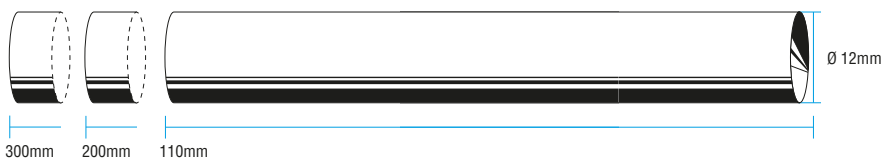

Available glue colour:

- Transparent
- White
- Honey
- Red
- Black
- Grey

**M12 H12**

Original Maestri glue recommended  
Page 109

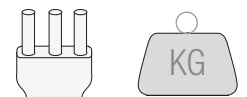

AC220/240V  
50-60 Hz

0,70



# M 812

## GLUE GUN

Powerful electric glue gun for hot melt adhesives, for large productions and heavy-duty work. Suited for professional use for wood, plastic, cardboard, paper, fabric, rubber and leather assembly and repairs, tile and porcelain installation and repairs. For standard Ø 12 mm glue.

### Extreme PROFESSIONAL

Insulated anti-drop nozzle, removable and interchangeable.



Power 400W

Maximum glue output/hour: 1,8 kg/h.

Temperature control to manage operating temperature.



On/off switch.



Available in:



included:

- ▶ 1 spare nozzle
- ▶ 1 screwdriver

Insulation class:

- ▶ CLASS 1

Compliant with directives:

- ▶ ROHS
- ▶ 2006/42/CE

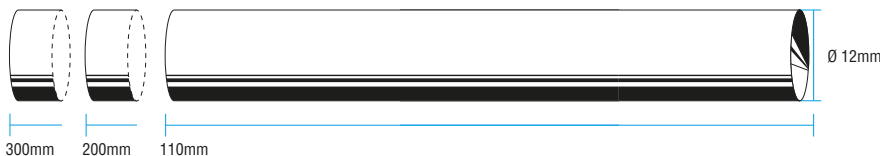

Available glue colour:

- Transparent
- White
- Honey
- Red
- Black
- Grey

**M12 | H12**

Original Maestri glue recommended  
Page 109

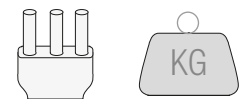

AC220/240V  
50-60 Hz

KG

1,05



# GLUE GUN ELECTRONIC FEED



## M812 MG

Glue gun with innovative electronic glue feed device for the most intense work, where a high extrusion capacity

is required in order not to tire your hand. Suitable for professional use for assembly and repairs on wood, plastic,

cardboard, paper, fabric, rubber, leather, laying and repairing of tiles and porcelain. For standard glues Ø 12 mm.

CODE	ARTICLE	PACK
0291114	M812 MG	1

### Extreme PROFESSIONAL

Insulated anti-drop nozzle, removable and interchangeable.



Power 450W

Maximum glue output/hour: 2,5 kg/h.

Temperature indicator: green light ready for use.



On/off switch.



Available in:



included:

- ▶ 1 spare nozzle

Insulation class:

- ▶ CLASS 1

Compliant with directives:

- ▶ ROHS
- ▶ 2006/42/CE

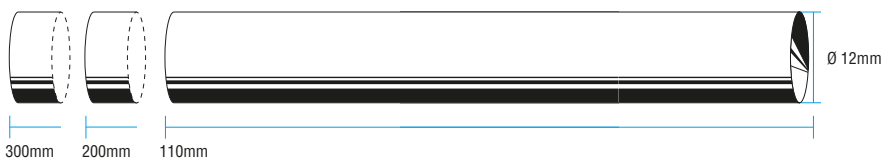

Available glue colour:

- Transparent
- White
- Honey
- Red
- Black
- Grey

M12 H12

Original Maestri glue recommended  
Page 109

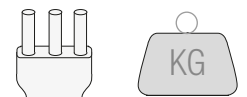

AC220/240V  
50-60 Hz

1,40



# M7/M12/H12 L12

European product compliant with regulation

► REACH (CE) n°1907/2006

## HOT MELT GLUE STICK

To assemble, glue and repair wood, plastic, cardboard, paper, fabric, pre-heated metal, rubber,

leather. Tile and porcelain installation and repairs. Costume jewellery, DIY.

MADE in ITALY



Maestri, always attentive to the environment, has decided to use renewable energy to manufacture this article.

**Green energy**  
Maestri da sempre sensibile alla salute ambientale, ha scelto di utilizzare energia derivante da fonti rinnovabili per la produzione di questo articolo.  
**MADE IN ITALY**

**COLLA TERMOFUSIBILE  
HOT MELT GLUE STICKS**



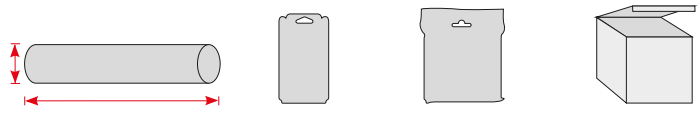

CODE	ARTICLE	PACK	STICK	BLISTER	BAG	BOX
1195207	M 12/200 TRANSPARENT	10	Ø 12 mm / 200 mm		● 1 kg	
1195210	M 12/200 HONEY	10	Ø 12 mm / 200 mm		● 1 kg	
1195212	M 12/200 HONEY SUITABLE FOR GLOSSY CARDBOARDS	10	Ø 12 mm / 200 mm		● 1 kg	
1195213	M 12/200 WHITE	5	Ø 12 mm / 200 mm			○ 5 kg
1195209	M 12/200 TRANSPARENT	5	Ø 12 mm / 200 mm			● 5 kg
1195215	M 12/200 HONEY	5	Ø 12 mm / 200 mm			● 5 kg
1196710	M 12/200 TRANSPARENT	10	Ø 12 mm / 200 mm	● 280 g		
1196711	M 12/200 WHITE	10	Ø 12 mm / 200 mm	○ 280 g		
1196712	M 12/200 HONEY	10	Ø 12 mm / 200 mm	● 280 g		
1195230	H 12/200 TRANSPARENT	5	Ø 12 mm / 200 mm			● 5 kg
1195234	H 12/200 TRANSPARENT	10	Ø 12 mm / 200 mm		● 1 kg	
1195250	H 12/300 TRANSPARENT	10	Ø 12 mm / 300 mm			● 10 kg
1195252	H 12/300 WHITE	10	Ø 12 mm / 300 mm			○ 10 kg
1196720	M 12/110 TRANSPARENT	12	Ø 12 mm / 110 mm	● 100 g		
1196721	M 12/110 RED	12	Ø 12 mm / 110 mm	● 100 g		
1196722	M 12/110 BLACK	12	Ø 12 mm / 110 mm	● 100 g		
1196723	M 12/110 GREY	12	Ø 12 mm / 110 mm	● 100 g		
1196740	M 7/100 TRANSPARENT	24	Ø 7 mm / 100 mm	● 70 g		
1196750	M 7/100 TRANSPARENT	36	Ø 7 mm / 100 mm		● 200 g	
1295111	HONEY 213/43	10	Ø 43 mm / 43 mm			● 10 Kg
1195102	L 12/200 TRANSPARENT LOW TEMPERATURE	5	Ø 12 mm / 200 mm		● 1 Kg	

## FASTENING

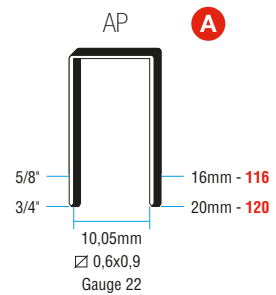
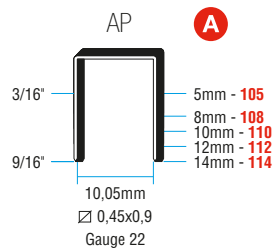
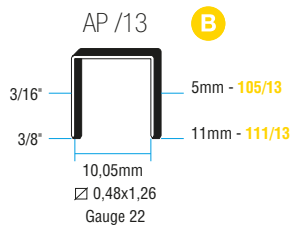

CODE	ARTICLE	PACK
1101503	105/13 AP - 5.000	240.000
>1110220	RO-MA 111/13 AP - 672	15

> blister

CODE	ARTICLE	PACK
1101301	105 AP - 5.000	300.000
1101303	108 AP - 5.000	240.000
1101207	112 AP - 5.000	150.000
1101209	114 AP - 5.000	120.000
>1110125	RO-MA 110 AP - 960	15
>1110126	RO-MA 112 AP - 840	15
>1110128	RO-MA 114 AP - 720	15

> blister

CODE	ARTICLE	PACK
1110130	RO-MA 116 AP - 600	15
1110132	RO-MA 120 AP - 480	15

> blister

PAGE

5 7 19 23

PAGE

5 7 9 11 13 18 19 21  
23 25 29 33 37

PAGE

11 13 37



# FASTENING

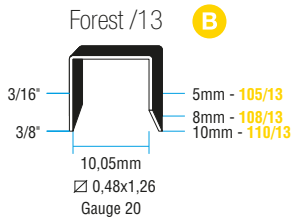

CODE	ARTICLE	PACK
1101401	105/13 FOREST - 5.000	240.000
1101403	108/13 FOREST - 5.000	180.000
1101405	110/13 FOREST - 5.000	120.000
1101402	105/13 FOREST BLACK EDITION - 5.000	50.000
1101404	108/13 FOREST BLACK EDITION - 5.000	50.000
1101406	110/13 FOREST BLACK EDITION - 5.000	50.000
>1110201	RO-MA 105/13 FOREST - 1.092	15
>1110203	RO-MA 108/13 FOREST - 840	15
>1110205	RO-MA 110/13 FOREST - 672	15

PAGE			
5	7	19	23

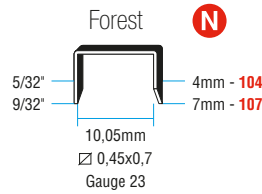

CODE	ARTICLE	PACK
1101001	104 FOREST - 5.000	480.000
1101007	107 FOREST - 5.000	360.000

PAGE			
5			

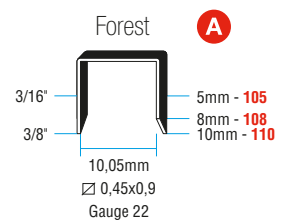

CODE	ARTICLE	PACK
1101201	105 FOREST - 5.000	300.000
1101203	108 FOREST - 5.000	240.000
1101205	110 FOREST - 5.000	210.000
1101202	105 FOREST BLACK EDITION - 5.000	50.000
1101204	108 FOREST BLACK EDITION - 5.000	50.000
1101206	110 FOREST BLACK EDITION - 5.000	50.000
>1110120	RO-MA 105 FOREST - 1.764	15
>1110122	RO-MA 108 FOREST - 1.764	15
>1110124	RO-MA 110 FOREST - 1.008	15

PAGE						
5	7	9	11	13	18	19
23	25	29	33	37		21

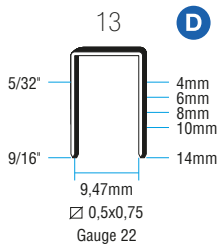

CODE	ARTICLE	PACK
1101701	M 13/4 ZINC-PLATED - 5.000	80.000
1101703	M 13/6 ZINC-PLATED - 5.000	70.000
1101705	M 13/8 ZINC-PLATED - 5.000	110.000
1101707	M 13/10 ZINC-PLATED - 5.000	80.000
1101711	M 13/14 ZINC-PLATED - 5.000	60.000
>1110501	RO-MA 13/4 ZINC-PLATED - 3.360	15
>1110503	RO-MA 13/6 ZINC-PLATED - 2.240	15
>1110505	RO-MA 13/8 ZINC-PLATED - 2.240	15
>1110507	RO-MA 13/10 ZINC-PLATED - 1.120	15
>1110509	RO-MA 13/14 ZINC-PLATED - 1.120	15

PAGE					
7	9	11	15	23	25
				37	

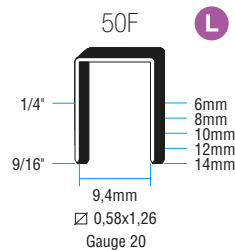

CODE	ARTICLE	PACK
1101801	M 50F/6 ZINC-PLATED - 10.000	180.000
1101802	M 50F/8 ZINC-PLATED - 5.000	160.000
1101803	M 50F/10 ZINC-PLATED - 5.000	130.000
1101804	M 50F/12 ZINC-PLATED - 5.000	110.000
1101805	M 50F/14 ZINC-PLATED - 5.000	100.000
>1110601	RO-MA 50F/6 ZINC-PLATED - 1.176	15
>1110603	RO-MA 50F/8 ZINC-PLATED - 840	15
>1110605	RO-MA 50F/10 ZINC-PLATED - 672	15
>1110607	RO-MA 50F/12 ZINC-PLATED - 588	15
>1110609	RO-MA 50F/14 ZINC-PLATED - 504	15

PAGE					
7	11	15	23	37	41

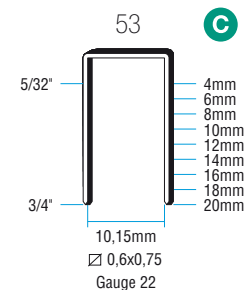

CODE	ARTICLE	PACK
1101603	M 53/6 ZINC-PLATED - 5.000	280.000
1101605	M 53/8 ZINC-PLATED - 5.000	270.000
1101607	M 53/10 ZINC-PLATED - 5.000	240.000
1101609	M 53/12 ZINC-PLATED - 5.000	210.000
1101611	M 53/14 ZINC-PLATED - 5.000	180.000
1101613	M 53/16 ZINC-PLATED - 4.000	144.000
1101615	M 53/18 ZINC-PLATED - 3.000	126.000
1101616	M 53/20 ZINC-PLATED - 3.000	126.000
>1110320	RO-MA 53/4 ZINC-PLATED - 2.940	15
>1110322	RO-MA 53/6 ZINC-PLATED - 1.960	15
>1110324	RO-MA 53/8 ZINC-PLATED - 1.960	15
>1110326	RO-MA 53/10 ZINC-PLATED - 1.120	15
>1110328	RO-MA 53/12 ZINC-PLATED - 980	15
>1110330	RO-MA 53/14 ZINC-PLATED - 840	15
>1110332	RO-MA 53/16 ZINC-PLATED - 700	15
>1110334	RO-MA 53/18 ZINC-PLATED - 560	15
>1110336	RO-MA 53/20 ZINC-PLATED - 560	15

PAGE						
5	7	9	11	13	16	17
23	25	33	35	37		21

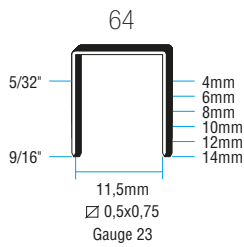

CODE	ARTICLE	PACK
1201001	64/4 BRONZE-PLATED - 20.000	360.000
1201003	64/6 BRONZE-PLATED - 10.000	360.000
1201005	64/8 BRONZE-PLATED - 10.000	270.000
1201007	64/10 BRONZE-PLATED - 10.000	270.000
1201009	64/12 BRONZE-PLATED - 10.000	180.000
1201011	64/14 BRONZE-PLATED - 10.000	180.000

PAGE

48

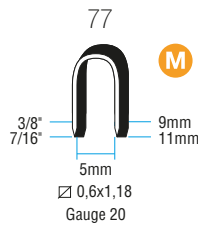

CODE	ARTICLE	PACK
1102001	77/9 ZINC-PLATED - 1.000	30.000
1102003	77/11 ZINC-PLATED - 1.000	30.000
>1130501	RO-MA 77/9 ZINC-PLATED - 1.440	15
>1130503	RO-MA 77/11 ZINC-PLATED - 1.152	15

> blister

PAGE

14

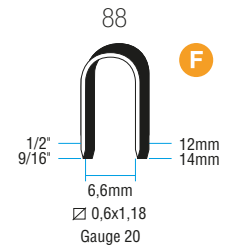

CODE	ARTICLE	PACK
1102005	88/12 ZINC-PLATED - 1.000	30.000
1102007	88/14 ZINC-PLATED - 1.000	30.000
> 1130505	RO-MA 88/12 ZINC-PLATED - 1.152	15
> 1130507	RO-MA 88/14 ZINC-PLATED - 864	15

> blister

PAGE

14

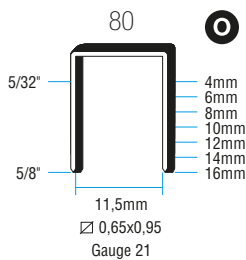

CODE	ARTICLE	PACK
1201103	80/4 BRONZE-PLATED - 10.000	300.000
1201105	80/6 BRONZE-PLATED - 10.000	240.000
1201107	80/8 BRONZE-PLATED - 10.000	180.000
1201109	80/10 BRONZE-PLATED - 10.000	180.000
1201111	80/12 BRONZE-PLATED - 10.000	120.000
1201113	80/14 BRONZE-PLATED - 10.000	120.000
1201117	80/16 BRONZE-PLATED - 10.000	120.000

1201160	80/6 RED EDITION BRONZE-PLATED - 5.000	50.000
1201161	80/8 RED EDITION BRONZE-PLATED - 5.000	50.000
1201162	80/10 RED EDITION BRONZE-PLATED - 5.000	50.000
1201163	80/12 RED EDITION BRONZE-PLATED - 5.000	50.000
1201164	80/14 RED EDITION BRONZE-PLATED - 5.000	50.000
1201165	80/16 RED EDITION BRONZE-PLATED - 5.000	50.000

1201401	80/4 GALVA - 10.000	200.000
1201403	80/6 GALVA - 10.000	200.000
1201405	80/8 GALVA - 10.000	200.000
1201407	80/10 GALVA - 10.000	100.000
1201409	80/12 GALVA - 10.000	100.000
1201411	80/14 GALVA - 10.000	100.000
1201413	80/16 GALVA - 10.000	100.000

1201901	80/4 STAINLESS STEEL - 20.000	240.000
1201903	80/6 STAINLESS STEEL - 10.000	240.000
1201905	80/8 STAINLESS STEEL - 10.000	180.000
1201907	80/10 STAINLESS STEEL - 10.000	180.000
1201909	80/12 STAINLESS STEEL - 10.000	120.000
1201911	80/14 STAINLESS STEEL - 10.000	120.000

>1111230	RO-MA 80/8 STAINLESS STEEL - 1.128	15
> 1111231	RO-MA 80/10 STAINLESS STEEL - 940	15
> 1111232	RO-MA 80/14 STAINLESS STEEL - 752	15

> blister		
-----------	--	--

PAGE

11 37 41 46 47

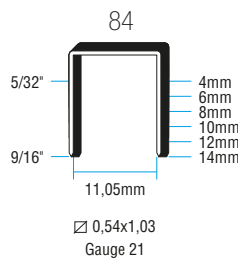

CODE	ARTICLE	PACK
1201201	84/4 BRONZE-PLATED - 10.000	200.000
1201203	84/6 BRONZE-PLATED - 10.000	240.000
1201205	84/8 BRONZE-PLATED - 10.000	180.000
1201207	84/10 BRONZE-PLATED - 10.000	180.000
1201209	84/12 BRONZE-PLATED - 10.000	120.000
1201211	84/14 BRONZE-PLATED - 10.000	120.000

PAGE

49

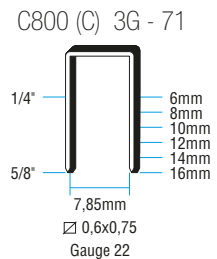

CODE	ARTICLE	PACK
1261104	C 806 ZINC-PLATED - 25.000	280.000
1261108	C 808 ZINC-PLATED - 28.000	224.000
1261113	C 810 ZINC-PLATED - 25.000	200.000
1261116	C 812 ZINC-PLATED - 35.000	140.000
1261119	C 814 ZINC-PLATED - 32.000	128.000
1261124	C 816 ZINC-PLATED - 27.000	108.000

PAGE

11 41

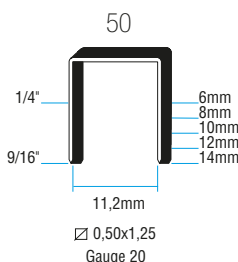

CODE	ARTICLE	PACK
11	41	

PAGE

11 41

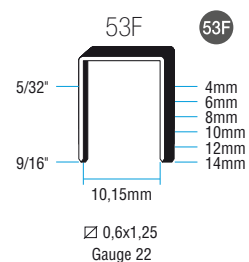

CODE	ARTICLE	PACK
7	23	

PAGE

7 23

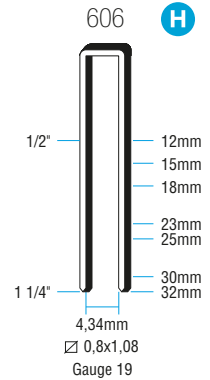
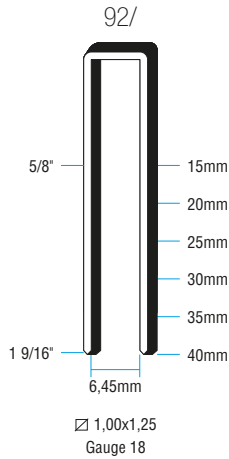
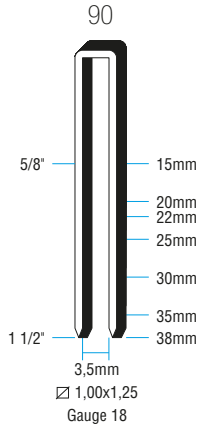

CODE	ARTICLE	PACK
1202001	90/15 BRONZE-PLATED - 5.000	80.000
1202002	90/20 BRONZE-PLATED - 5.000	60.000
1202003	90/22 BRONZE-PLATED - 5.000	50.000
1202005	90/25 BRONZE-PLATED - 5.000	50.000
1202007	90/30 BRONZE-PLATED - 5.000	40.000
1202011	90/35 BRONZE-PLATED - 5.000	40.000
1202013	90/38 BRONZE-PLATED - 5.000	30.000

CODE	ARTICLE	PACK
1202100	92/15 BRONZE-PLATED - 7.000	70.000
1202101	92/20 BRONZE-PLATED - 5.000	60.000
1202103	92/25 BRONZE-PLATED - 4.000	48.000
1202105	92/30 BRONZE-PLATED - 4.000	40.000
1202107	92/35 BRONZE-PLATED - 3.000	30.000
1202109	92/40 BRONZE-PLATED - 3.000	30.000

CODE	ARTICLE	PACK
1202301	M 606/12 ZINC-PLATED - 5.000	100.000
1202303	M 606/15 ZINC-PLATED - 5.000	100.000
1202307	M 606/23 ZINC-PLATED - 5.000	50.000
1202310	M 606/30 ZINC-PLATED - 2.200	24.200
1202311	M 606/32 ZINC-PLATED - 2.200	24.200
1202317	M 606/18 DP ZINC-PLATED - 4.800	57.600
1202319	M 606/23 DP ZINC-PLATED - 4.800	57.600
>1110420	RO-MA 606/12 ZINC-PLATED - 1.176	15
> 1110422	RO-MA 606/15 ZINC-PLATED - 980	15
> 1110424	RO-MA 606/18 ZINC-PLATED - 784	15
> 1110426	RO-MA 606/23 ZINC-PLATED - 588	15
> 1110428	RO-MA 606/25 ZINC-PLATED - 588	15

PAGE	
51	53

PAGE	
50	

PAGE	
37	41

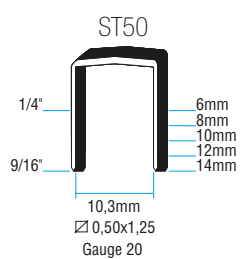
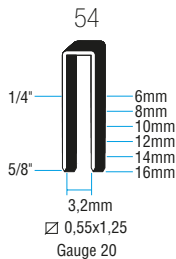
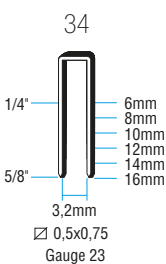
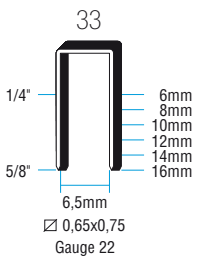

PAGE	
11	

PAGE	
11	41

PAGE	
11	

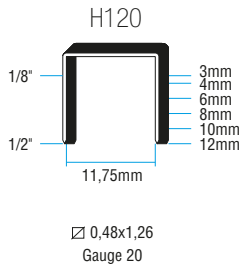

Ø 0,48x1,26  
Gauge 20

CODE	ARTICLE	PACK
1261502	H 123 ZINC-PLATED - 10.000	100.000
1261507	H 124 ZINC-PLATED - 16.200	97.200
1261515	H 126 ZINC-PLATED - 34.000	136.000
1261522	H 128 ZINC-PLATED - 30.000	120.000
1261528	H 1210 ZINC-PLATED - 8.400	100.800
1261536	H 1212 ZINC-PLATED - 14.000	56.000
1261511	H124 STAINLESS STEEL - 5.000	260.000
1261518	H126 STAINLESS STEEL - 3.000	70.000
1261540	H1212 STAINLESS STEEL - 7.000	56.000

PAGE

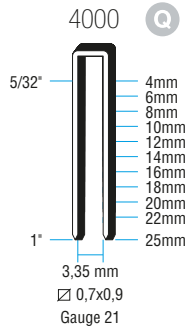

Ø 0,7x0,9  
Gauge 21

CODE	ARTICLE	PACK
1201300	4004 BRONZE-PLATED - 20.000	600.000
1201301	4006 BRONZE-PLATED - 20.000	400.000
1201303	4008 BRONZE-PLATED - 20.000	320.000
1201305	4010 BRONZE-PLATED - 10.000	300.000
1201307	4012 BRONZE-PLATED - 10.000	250.000
1201309	4014 BRONZE-PLATED - 10.000	200.000
1201311	4016 BRONZE-PLATED - 10.000	180.000
1201313	4018 BRONZE-PLATED - 10.000	160.000
1201315	4020 BRONZE-PLATED - 10.000	120.000
1201317	4022 BRONZE-PLATED - 10.000	120.000
1201318	4025 BRONZE-PLATED - 10.000	100.000
1201320	4016 DP BRONZE-PLATED - 10.000	100.000
1201322	4020 DP BRONZE-PLATED - 10.000	100.000

PAGE

41

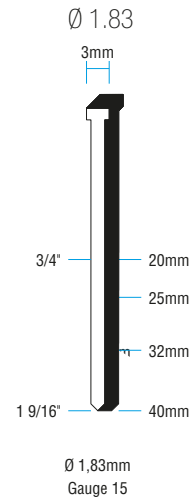

Ø 1.83mm  
Gauge 15

CODE	ARTICLE	PACK
1233149	Ø1.83 - 20 mm 3.000	30.000
1233150	Ø1.83 - 25 mm 3.000	15.000
1233152	Ø1.83 - 32 mm 1.500	15.000
1233153	Ø1.83 - 40 mm 1.500	15.000

PAGE

56

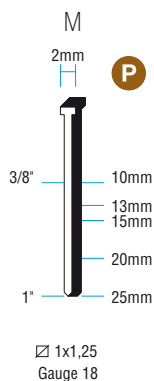

Ø 1x1,25  
Gauge 18

CODE	ARTICLE	PACK
>1130800	RO-MA M10 ZINC-PLATED - 3.500	15
>1130801	RO-MA M13 ZINC-PLATED - 2.500	15
>1130803	RO-MA M15 ZINC-PLATED - 1.700	15
>1130805	RO-MA M20 ZINC-PLATED - 1.500	15
>1130807	RO-MA M25 ZINC-PLATED - 1.200	15

> blister

PAGE

7 9 11 13 17 21 23 25  
29 33 35

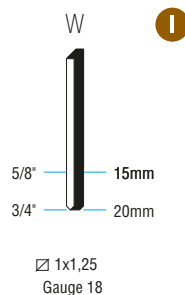

Ø 1x1,25  
Gauge 18

CODE	ARTICLE	PACK
>1130820	RO-MA W15 ZINC-PLATED - 2.000	15
>1130822	RO-MA W20 ZINC-PLATED - 2.000	15

> blister

PAGE

11 13 33

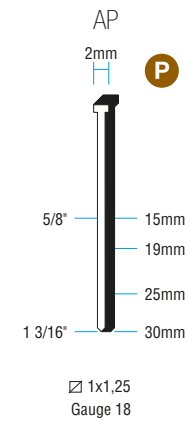

Ø 1x1,25  
Gauge 18

CODE	ARTICLE	PACK
1231131	AP15 - 15 mm - 5.000	150.000
1231133	AP19 - 19 mm - 5.000	100.000
1231135	AP25 - 25 mm - 5.000	100.000
1231137	AP30 - 30 mm - 5.000	50.000

PAGE

37 39 41 43



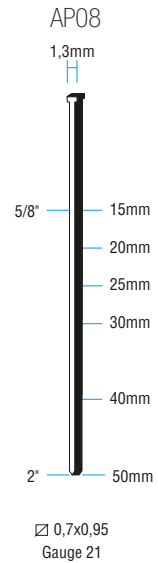
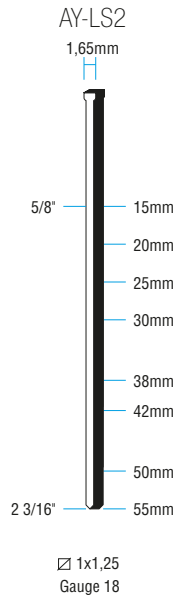
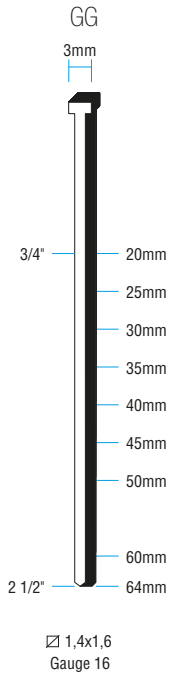

CODE	ARTICLE	PACK
1233100	<b>GG20 - 20 mm - 4.000</b>	80.000
1233101	<b>GG25 - 25 mm - 4.000</b>	64.000
1233103	<b>GG30 - 30 mm - 4.000</b>	48.000
1233105	<b>GG35 - 35 mm - 4.000</b>	48.000
1233107	<b>GG40 - 40 mm - 4.000</b>	32.000
1233109	<b>GG45 - 45 mm - 4.000</b>	32.000
1233111	<b>GG50 - 50 mm - 4.000</b>	32.000
1233120	<b>GG60 - 60 mm - 4.000</b>	32.000
1233121	<b>GG64 - 64 mm - 4.000</b>	32.000

CODE	ARTICLE	PACK
1273301	<b>AY-LS2 15 mm GALVA - 8.000</b>	128.000
1273303	<b>AY-LS2 20 mm GALVA - 7.000</b>	112.000
1273305	<b>AY-LS2 25 mm GALVA - 5.000</b>	80.000
1273307	<b>AY-LS2 30 mm GALVA - 4.000</b>	64.000
1273309	<b>AY-LS2 38 mm GALVA - 4.000</b>	64.000
1273311	<b>AY-LS2 42 mm GALVA - 3.000</b>	48.000
1273313	<b>AY-LS2 50 mm GALVA - 2.500</b>	40.000
1273315	<b>AY-LS2 55 mm GALVA - 2.000</b>	32.000

CODE	ARTICLE	PACK
1231301	<b>AP08 - 15 mm - 6.100</b>	61.000
1231303	<b>AP08 - 20 mm - 6.100</b>	61.000
1231305	<b>AP08 - 25 mm - 6.100</b>	61.000
1231307	<b>AP08 - 30 mm - 6.100</b>	61.000
1231309	<b>AP08 - 40 mm - 4.000</b>	40.000
1231310	<b>AP08 - 50 mm - 4.000</b>	40.000

## FASTENING

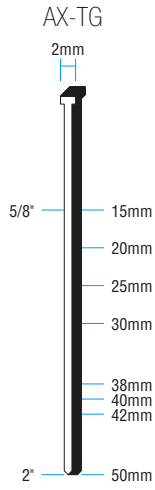

□ 1x1,25  
Gauge 18

CODE	ARTICLE	PACK
1164001	AX-TG 15 mm - 5.000	150.000
1164003	AX-TG 20 mm - 5.000	100.000
1164005	AX-TG 25 mm - 5.000	100.000
1164007	AX-TG 30 mm - 5.000	50.000
1164009	AX-TG 38 mm - 5.000	50.000
1164011	AX-TG 40 mm - 5.000	50.000
1164012	AX-TG 42 mm - 6.000	36.000
1164014	AX-TG 50 mm - 5.000	50.000

PAGE

53 54 55 57

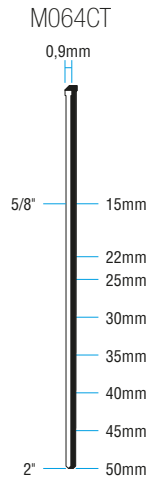

∅ 0,64mm  
Gauge 23

CODE	ARTICLE	PACK
1234120	M064CT 15 mm - 20.000	480.000
1234122	M064CT 22 mm - 20.000	320.000
1234124	M064CT 25 mm - 20.000	320.000
1234126	M064CT 30 mm - 10.000	240.000
1234127	M064CT 35 mm - 10.000	180.000
1234128	M064CT 40 mm - 10.000	180.000
1234129	M064CT 45 mm - 10.000	180.000
1234130	M064CT 50 mm - 10.000	120.000

PAGE

58 59

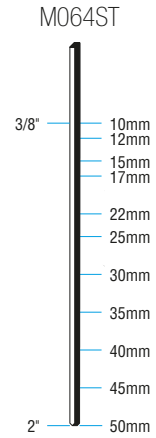

∅ 0,64mm  
Gauge 23

CODE	ARTICLE	PACK
1234101	M064ST 10 mm - 30.000	240.000
1234103	M064ST 12 mm - 20.000	360.000
1234105	M064ST 15 mm - 20.000	360.000
1234107	M064ST 17 mm - 20.000	360.000
1234109	M064ST 22 mm - 10.000	180.000
1234111	M064ST 25 mm - 10.000	180.000
1234113	M064ST 30 mm - 10.000	180.000
1234114	M064ST 35 mm - 10.000	240.000
1234115	M064ST 40 mm - 10.000	180.000
1234116	M064ST 45 mm - 10.000	180.000
1234117	M064ST 50 mm - 10.000	120.000

PAGE

58 59

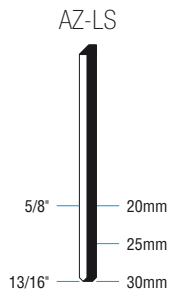

□ 1x1,25  
Gauge 18

CODE	ARTICLE	PACK
1271117	AZ-LS 20 mm GALVA - 8.000	128.000
1271121	AZ-LS 25 mm GALVA - 7.000	112.000
1271123	AZ-LS 30 mm GALVA - 6.000	96.000

PAGE

57

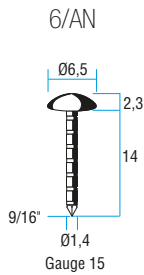

CODE	ARTICLE	PACK
1292102	6/AN BRASSED - 4.000	36.000
1292103	6/AN NICKELED - 4.000	36.000
1292107	6/AN BRASSED WALNUT - 4.000	36.000
1292108	6/AN SHINNY BRASSED WALNUT - 4.000	36.000
1292110	6/AN NICKEL FREE - 4.000	36.000
1292111	6/AN NICKEL FREE GUN METAL - 4.000	36.000
1292112	6/AN BURNISHED BRASS - 4.000	36.000
1292129	6/AN GUN METAL - 4.000	36.000
1292115	6/AN GUN METAL BLACK - 4.000	36.000
1292120	6/AN BRONZE REINASSANCE - 4.000	36.000
1292104	6/AN OLD BRASS - 4.000	36.000
1292106	6/AN NICKELED SHANK 10 mm - 4.000	36.000
1292109	6/AN BRIGHT OLD GOLD - 4.000	36.000
1292114	6/AN NICKEL-FREE SHANK 10 mm - 4.000	36.000
1292116	6/AN BRASSED WALNUT SHANK 10 mm - 4.000	36.000
1292126	6/AN OLD NICKEL - 4.000	36.000

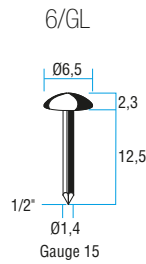

CODE	ARTICLE	PACK
1292012	6/GL BRIGHT BRASS - 4.000	36.000
1292013	6/GL SHINNY BRASSED WALNUT - 4.000	36.000
1292001	6/GL BRONZE REINASSANCE - 4.000	36.000
1292002	6/GL BRASSED - 4.000	36.000
1292003	6/GL NICKELED - 4.000	36.000
1292009	6/GL BRASSED WALNUT - 4.000	36.000
1292010	6/GL NICKEL FREE - 4.000	36.000
1292025	6/GL GUN METAL - 4.000	36.000
1292011	6/GL NICKEL FREE GUN METAL - 4.000	36.000
1292015	6/GL BURNISHED BRASS - 4.000	36.000
1292004	6/GL OLD GOLD - 4.000	36.000
1292027	6/GL BRASSED FREE - 4.000	36.000

6/AN FLATHEAD

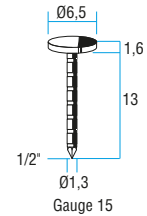

CODE	ARTICLE	PACK
1292140	6/AN BRASSED FLATHEAD STUD - 4.000	36.000
1292142	6/AN OLD BRASS FLATHEAD STUD - 4.000	36.000
1292143	6/AN NICKELED FLATHEAD STUD - 4.000	36.000

7S/AN

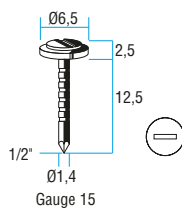

CODE	ARTICLE	PACK
1292151	7S/AN BRASSED SCREW HEAD - 4.000	36.000
1292153	7S/AN NICKELED SCREW HEAD - 4.000	36.000
1292157	7S/AN NICKEL FREE SCREW HEAD - 4.000	36.000
1292158	7S/AN BRASSED FREE SCREW HEAD - 4.000	36.000

7S/AN - SCR

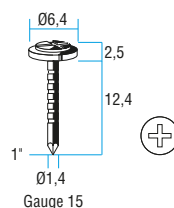

CODE	ARTICLE	PACK
1292154	7S/AN BRASSED SCREW HEAD SCR - 4.000	36.000

## FASTENING

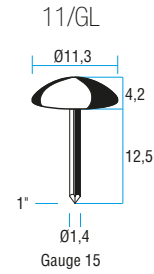
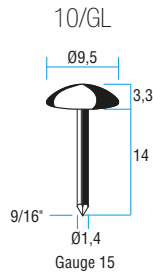
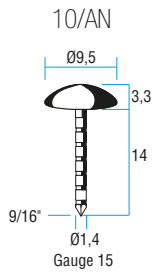

CODE	ARTICLE	PACK
1292501	10/AN BRASSED - 2.000	18.000
1292502	10/AN NICKELED - 2.000	18.000
1292510	10/AN GUN METAL - 2.000	18.000
1292506	10/AN BRONZE REINASSANCE - 2.000	18.000
1292508	10/AN OLD BRASS - 2.000	18.000
1292509	10/AN BRIGHT OLD GOLD - 2.000	18.000
1292549	10/AN BRASSED WALNUT - 2.000	18.000
1292580	10/AN NICKEL FREE - 2.000	18.000

CODE	ARTICLE	PACK
1292401	10/GL BRASSED - 2.000	18.000
1292402	10/GL NICKELED - 2.000	18.000
1292405	10/GL OLD GOLD - 2.000	18.000
1292410	10/GL OLD GOLD HAMMERED - 2.000	18.000
1292412	10/GL BRONZE REINASSANCE - 2.000	18.000
1292403	10/GL BLACK - 2.000	18.000
1292404	10/GL BRUEN - 2.000	18.000

CODE	ARTICLE	PACK
1292603	11/GL BRIGHT OLD GOLD - 1.333	12.000
1292817	11/GL OLD GOLD - 1.333	12.000
1292818	11/GL BRIGHT BRASS - 1.333	12.000
1292819	11/GL OLD BRASS - 1.333	12.000
1292815	11,5/GL BRONZE REINASSANCE - 1.333	12.000
1292810	11,5/GL NATURAL - 1.333	12.000
1292811	11,5/GL OXFORD - 1.333	12.000
1292812	11,5/GL FRENCH NATURAL - 1.333	12.000
1292813	11,5/GL NICKELED - 1.333	12.000
1292814	11,5/GL BRASSED - 1.333	12.000
1292816	11,5/GL BLACK - 1.333	12.000

PAGE  
63

PAGE  
63

PAGE  
63

## FRAMING

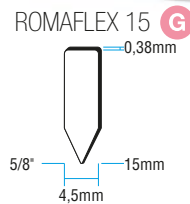
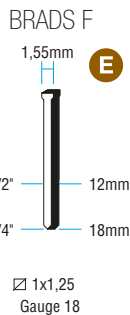

CODE	ARTICLE	PACK
1160205	F18 ZINC-PLATED - 5.000/20.000	100.000
> 1130840	RO-MA F12 ZINC-PLATED - 2.000	15
> 1130830	RO-MA F18 ZINC-PLATED - 2.000	15

> blister  
PAGE  
66 67 68 69

CODE	ARTICLE	PACK
1299056	ROMAFLEX 15 - 5.000	80.000
> 1130901	ROMAFLEX 15 - 2.080	15

> blister  
PAGE  
70 71



# PACKAGING

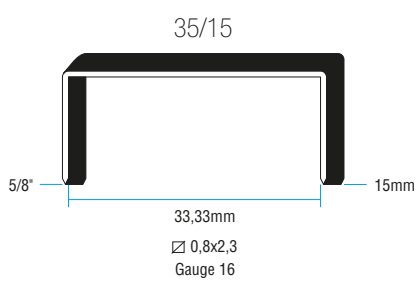

CODE	ARTICLE	PACK
1107001	<b>35/15 COPPER-PLATED - 2.500</b>	25.000
PAGE		
74	75	76 77 80 81

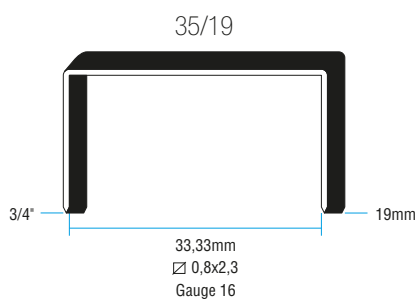

CODE	ARTICLE	PACK
1107005	<b>35/19 COPPER-PLATED - 2.000</b>	20.000
1107007	<b>35/19 NEUTRAL COPPER-PLATED - 2.000</b>	20.000
PAGE		
74	75	76 77 80 81

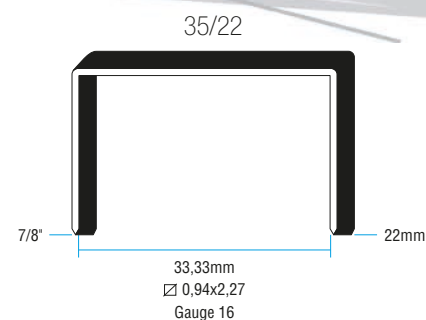

CODE	ARTICLE	PACK
1211205	<b>35/22 COPPER-PLATED - 1.500</b>	15.000
PAGE		
74	75	80 81

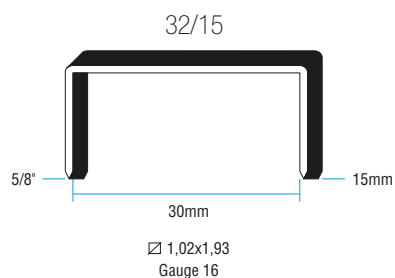

CODE	ARTICLE	PACK
1211103	<b>32/15 COPPER-PLATED - 2.000</b>	20.000
PAGE		

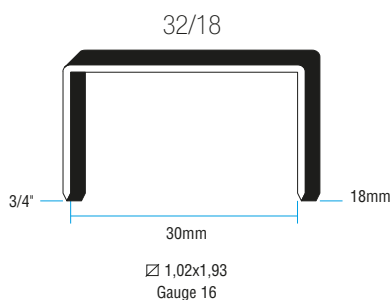

CODE	ARTICLE	PACK
1211105	<b>32/18 COPPER-PLATED - 2.000</b>	20.000
PAGE		

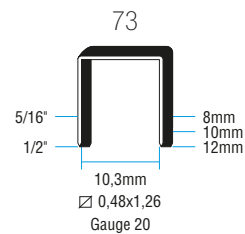

CODE	ARTICLE	PACK
1101810	<b>73/8 ZINC-PLATED - 5.000</b>	80.000
1101811	<b>73/10 ZINC-PLATED - 5.000</b>	70.000
1101812	<b>73/12 ZINC-PLATED - 5.000</b>	60.000
PAGE		
79		

## PACKAGING

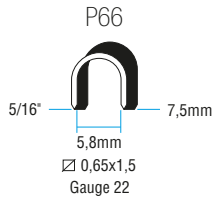

CODE	ARTICLE	PACK
1213005	<b>P66 ZINC-PLATED - 5.000</b>	100.000

PAGE

613 M (medium)

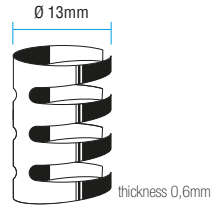

CODE	ARTICLE	PACK
> 1291109	<b>613 M - 10.000 pcs</b>	100.000
> printing for 500.000 pieces ask previously for quotation		

PAGE

613 P (heavy)

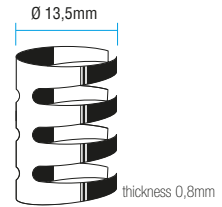

CODE	ARTICLE	PACK
> 1291110	<b>613 P - 10.000 pcs</b>	100.000
> printing for 500.000 pieces ask previously for quotation		

PAGE

617 L (light)

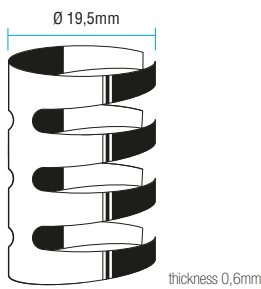

CODE	ARTICLE	PACK
> 1291131	<b>617 L - 12.000 pcs</b>	48.000
> printing for 500.000 pieces ask previously for quotation		

PAGE

617 P (heavy)

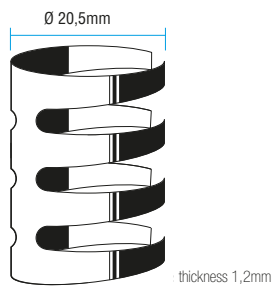

CODE	ARTICLE	PACK
> 1291139	<b>617 P - 12.000 pcs</b>	48.000
> printing for 500.000 pieces ask previously for quotation		

PAGE

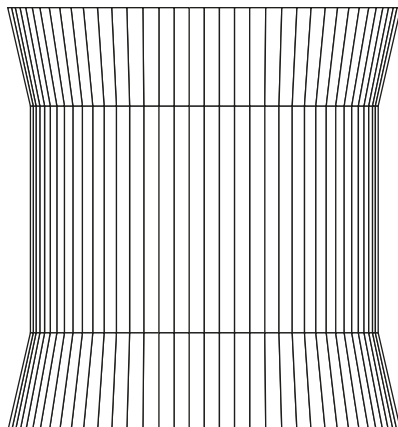

M15/A - M19/A

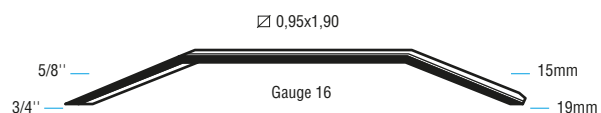

CODE	ARTICLE	PACK
1299978	<b>M15/A COPPER-PLATED - 1.000</b>	24.000
1299977	<b>M19/A COPPER-PLATED - 1.000</b>	24.000

PAGE

78

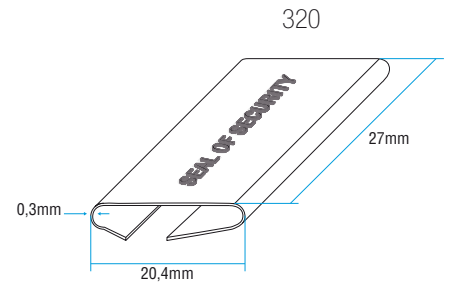
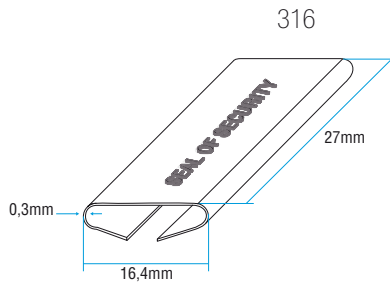
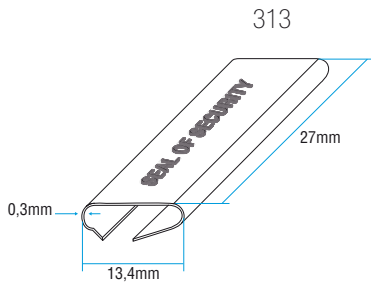

CODE	ARTICLE	PACK
1190120	313 NEUTRAL STEEL	3.000
> 1190121	313 STEEL PRINTED	2.000
> printing for 50.000 pieces		

CODE	ARTICLE	PACK
1190132	316 NEUTRAL STEEL	3.000
> 1190133	316 STEEL PRINTED	3.000
> printing for 50.000 pieces		

CODE	ARTICLE	PACK
1190152	320 NEUTRAL - STEEL	3.000
> 1190153	320 STEEL PRINTED	2.000
> printing for 50.000 pieces		

PAGE		
85		

PAGE		
85		

PAGE		
85		

METAL STRAP

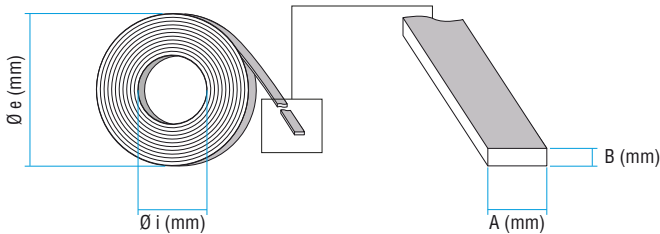

CODE	ARTICLE			Ø e (mm)	PACK (kg)
	A	B	FINISHING		
1192115	13	0.50	POLISHED	300 mm - 550 mm	30
1192125	16	0.50	POLISHED	300 mm - 550 mm	35
1192135	18	0.60	POLISHED	300 mm - 550 mm	40
1192145	20	0.60	POLISHED	300 mm - 550 mm	25
1290415	25	1.00	POLISHED	300 mm - 550 mm	30
1290423	30	1.00	POLISHED	300 mm - 550 mm	40
1290431	32	1.00	POLISHED	300 mm - 550 mm	40
1192127	16	0.50	HEAVY DUTY BLUE TINTED	300 mm - 550 mm	60
1192137	19	0.60	HEAVY DUTY BLUE TINTED	300 mm - 550 mm	75
1192136	19	0.60	ZINC-PLATED	300 mm - 550 mm	30
1192148	20	0.60	ZINC-PLATED	300 mm - 550 mm	25
1192139	19	0.60	PAINTED ZINC-PLATED	300 mm - 550 mm	35

PAGE			
85	86	87	

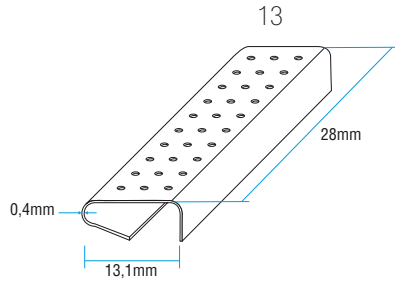

CODE	ARTICLE	PACK
> 1190006	<b>13 LA ENGRAVED</b>	2.500
<i>&gt; printing for 50.000 pieces ask previously for quotation</i>		
PAGE		
91		

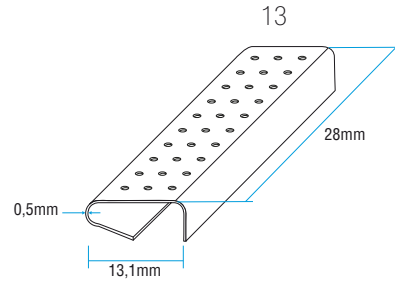

CODE	ARTICLE	PACK
> 1190010	<b>13 PA ENGRAVED</b>	2.500
<i>&gt; printing for 50.000 pieces ask previously for quotation</i>		
PAGE		
91		

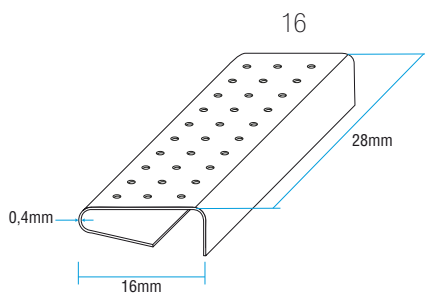

CODE	ARTICLE	PACK
> 1190021	<b>16 LA ENGRAVED</b>	2.000
<i>&gt; printing for 50.000 pieces ask previously for quotation</i>		
PAGE		
91		

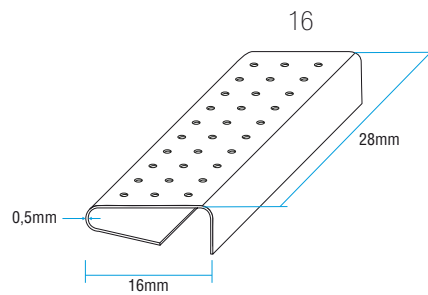

CODE	ARTICLE	PACK
> 1190023	<b>16 PA ENGRAVED</b>	2.000
<i>&gt; printing for 50.000 pieces ask previously for quotation</i>		
PAGE		
91		



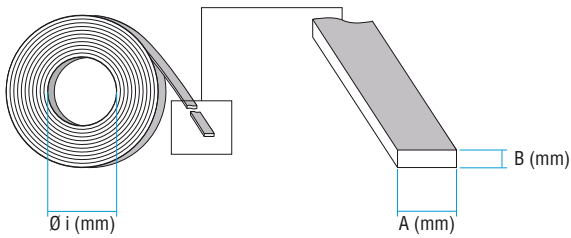

CODE	ARTICLE			PP	Ø i (mm)	PACK (mt)
	A	B	COLOUR			
1191105	12	0.50	BLACK	PP	60	4.000
1191107	12	0.60	BLACK	PP	60	4.000
1191108	12	0.80	BLACK	PP	60	3.800
1191121	15	0.50	BLACK	PP	60	3.600
1191125	15	0.60	BLACK	PP	60	3.600
1191128	15	0.80	BLACK	PP	60	3.200
1191151	12	0.50	BLACK	PP	400	3.000
1191153	12	0.60	BLACK	PP	400	2.500
1191155	12	0.80	BLACK	PP	400	2.000
1191173	15	0.50	BLACK	PP	400	2.000
1191175	15	0.60	BLACK	PP	400	2.000
1191177	15	0.80	BLACK	PP	400	1.500
1191179	15	0.80	WHITE	PP	400	1.500
PAGE						
91	92	93	94	95		

HOT SEALING PLASTIC STRAP

CODE	ARTICLE			PP	Ø i (mm)	PACK (mt)
	A	B	COLOUR			
1290306	6	0.50	WHITE	PP	200	4.800
1290304	9	0.50	WHITE	PP	200	4.000
1290305	9	0.60	WHITE	PP	200	3.500
1290308	12	0.50	WHITE	PP	200	3.000
1290307	12	0.58	WHITE	PP	200	3.000
1290312	12	0.60	WHITE	PP	200	2.500
1290311	12	0.60	BLACK	PP	200	3.000
1290317	12	0.80	BLACK	PP	200	2.000
1290313	12	0.60	WHITE	PP	280	2.500
1290315	12	0.60	WHITE	PP	400	2.500
1290320	12	0.80	WHITE	PP	400	2.000
1290319	12	0.80	BLACK	PP	400	2.000
1290323	15	0.60	BLACK	PP	400	2.000
1290325	15	0.80	BLACK	PP	400	1.500
1290329	12	0.60	GREEN	PET	400	2.500
1290330	15	0.60	GREEN	PET	400	2.000
1290326	15	0.80	GREEN	PET	400	1.500
1290328	19	0.90	GREEN	PET	400	1.000
PAGE						
91	92	93	94	95		

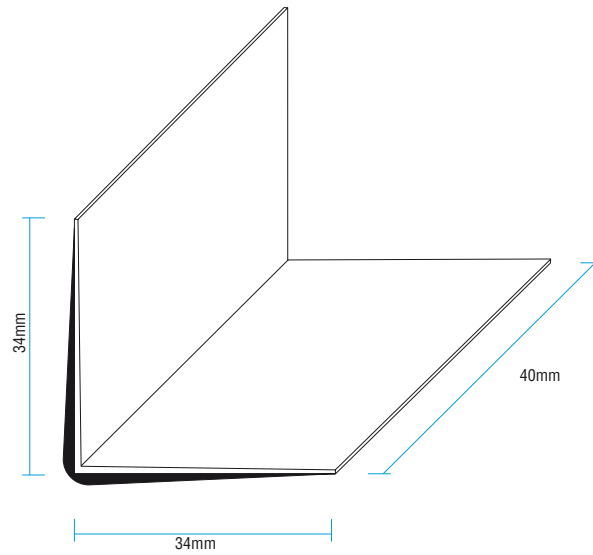

CODE	ARTICLE	PACK
1290130	4X4 MEDIUM CORNER PIECES	4.000

PAGE

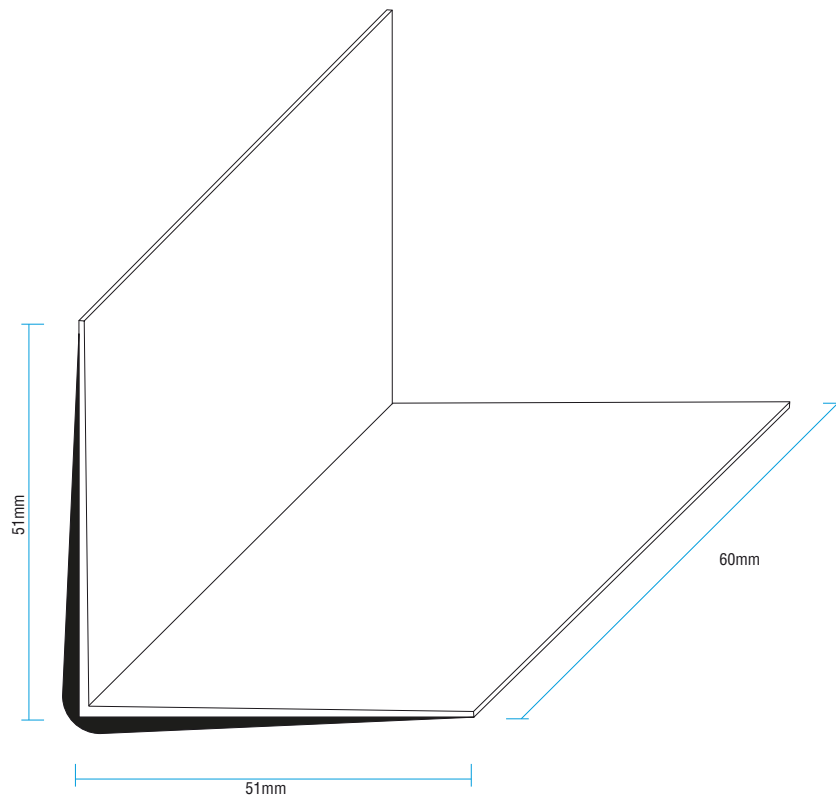

CODE	ARTICLE	PACK
1290132	6X6 LARGE CORNER PIECES	1.000

PAGE













*Fastening Systems*  
*since 1919*



## romeo maestri & figli s.p.a.

sistemi di cucitura a punto metallico - stapling systems manufacturer

via Milano, 5 - 20007 Cornaredo (MI) - Italy

tel +39 02.93619.1

[www.romeomaestri.com](http://www.romeomaestri.com) - [sales@romeomaestri.it](mailto:sales@romeomaestri.it)

